

PRODUCT GUIDE

INDUSTRIAL FASTENERS

Socket Screws	13
Pins	79
Wrenches and Tools	89
Durlok®	97
Technical Section	105

Table of Contents

		Metric	Inch
Socket Screws	Socket Head Cap Screw	16	–
	1960 Series	–	22
	Socket Low Head Cap Screw	31	32
	Socket Head Shoulder Screw	35	37
	Countersunk Socket Head Screw	40	43
	Button Head Socket Screw	48	50
	Flange Button Head Socket Screw	53	54
	Socket Set Screws :	57	66
	Knurled Point	63	69
	Flat Point	63	–
	Dog Point	64	–
	Cone Point	64	–
	Plain Point	65	70
	Taper Pressure Plugs	74	75
Pins	Dowel Pins	82	84
	Pull-Out Dowel Pins	–	87
Tools and Keys	Hexagon Wrenches	92	94
Durlok	Durlok® Screws	101	–
	Durlok® Nuts	102	–
	Durlok® Washers	104	–
Technical Section	Screw Fastener Theory and Application	106	
	Joint Diagrams	110	
	The Torque-Tension Relationship	116	
	Stripping Strength of Tapped Holes	118	
	High-Temperature Joints	122	
	Corrosion In Threaded Fasteners	125	
	Impact Performance	129	
	Product Engineering Bulletin	133	
	Metric Threads	134	
	Through-Hole Preparation	135	
	Drill and Counterbore Sizes	136	
	Hardness-Tensile Conversion Chart	137	
	Thread Stress Area	138	
	Thread Size Comparison	139	
Comparison of Different Strength Grades	140		

About Unbrako



West Coast Distribution Center

Founded in 1911, Unbrako is the world leader in advancing the technology of bolted joints and meeting the needs of industry for stronger and better performing fasteners. Products such as the famous Unbrako® socket head cap screw and Durluk® fasteners are the solutions of choice for engineering applications across the world & is used by industries such as the automotive, power generation, petrochemical, heavy machinery, construction and military sectors.

With an extensive international network in 35 countries, Unbrako provides a complete range of industrial fastening hardware including bolts, screws, SEM's, nuts, studbolts, self-locking fasteners, thread forming fasteners, among others.

Unbrako products are primarily used in performance critical applications and incorporate unique design and work-manship features that meet or exceed recognized international standards, resulting in higher tensile strength, improved fatigue resistance, ease of installation, reduced total cost of maintenance and extended life cycle.

With advanced manufacturing, engineering and logistics facilities, ISO/TS and CE certification, Unbrako is equipped to provide technical support and full-service package. Unbrako's focus is on building long - term relationships with its customers. Full-service includes engineering and design support, procurement and purchasing services, localized warehousing and transport, a variety of packaging options and choice of delivery frequencies – to provide the right answer to any customer need.

In this Guide

In this guide you will find complete information about Unbrako socket screws, pins, hex keys, self locking Durlok® fasteners and related products, in high-tensile alloy steel. Everything you need to select, specify and order these precision products is at your finger tips. Furthermore, all data has been organized to let you find the facts you want with the greatest speed and least effort.



Included in this guide are:

- Unbrako fastener product descriptions
- Features and technical data about each product
- Product sizes along with part numbers
- Technical discussions for application and use

Packaging:

Unbrako provides a full-service package designed to suit customer needs, including a variety of packaging options and choice of delivery frequencies. The standard packaging is explained with each product.

Types of packaging:

-  Pieces per Box – small box packing
-  Pieces per Carton – bulk packing in a carton
-  Pieces per Bag – bulk packing in a bag

Important Information

The use of precision fasteners in the worldwide market has led to the creation of many standards. These standards specify the fastener requirements: dimensions, material, strength levels, inspection etc. Different standards are the responsibility of various organization and are not always identical. Unbrako supplies precision fasteners manufactured to Unbrako internal specifications, designed to achieve maximum interchangeability with all standards. Reference Consensus standards referred to in this guide were current at the time of publication. However, Reference Consensus standards are subject to change by any standards organizations at any time.

A direct or indirect reference to a consensus standard to represent that a fastener conforms to particular requirements of the consensus standard shall not be construed as a representation that the fastener meets all the requirements of the consensus standard.

UNBRAKO products are manufactured in accordance with revisions valid at time of manufacture. Unbrako reserves the right to update or modify its manufacturing specifications without prior notice.

The specifications and other particulars contained in this Guide are subject to change without notice.



Limited Warranty and Exclusive Remedy



Deepak Fasteners Ltd., through its Unbrako Division and associated companies, warrants that these products conform to industry standards specified herein and will be free from defects in materials and workmanship. This warranty is expressly given in lieu of any and all other express or implied warranties, including any implied warranty of merchantability or fitness for a particular purpose, and in lieu of any other obligation on the part of Deepak Fasteners.

Deepak Fasteners will at its option, repair or replace free of charge (excluding all shipping and handling costs) any products which have not been subject to misuse, abuse, or modification and which in its sole determination were not manufactured in compliance with the warranty given above.

Deepak Fasteners makes no representations or warranties, express or implied, that anything imported, made, used, sold, or otherwise provided under any sale agreement is or will be free from infringement of patents / other proprietary rights of any third persons. Nothing in this application, or any agreement, shall be construed as giving rise to any obligation on Deepak Fasteners part to indemnify or hold harmless any Buyer from any liability relating to Buyer's purchase, use, or re-sale of Deepak Fasteners product, or the incorporation of Deepak Fasteners product into another manufactured product.

The remedy provided herein shall be the exclusive remedy for any breach of warranty or any claim arising in any way out of the manufacture, sale or use of these products. In no event shall Deepak Fasteners be liable for consequential, incidental or any other damages of any nature whatsoever except those specifically provided herein for any breach of warranty or any claim arising in any way of the manufacture, sale or use of these products. No other person is authorized by Deepak Fasteners to give any other warranty, written or oral, pertaining to the products.



Certified Laboratory

Our Laboratory is NABL ISO/IEC 17025:2005 certified, which facilitates in maintaining consistently high quality. The fasteners go through strict quality checks at every stage of the process. Our inspection facilities are equipped with state-of-the-art equipment for testing of both physical and metallurgical aspects of fasteners for the most demanding applications:

- Tensile & Hardness testing
- Salt spray testing
- Digital profile analysis
- X-ray analysis of coating thickness
- Chemical composition analysis (Spectrometer)
- Impact Testing
- Dynamic fatigue testing
- Torque tension and friction testing
- Eddy current Testing
- Metallurgical Microscope with Image Analyzer



International Certifications

Our production facilities are ISO 9001, ISO/TS 16949, ISO 14001 and BS OHSAS 18001 Certified. Our fasteners meet or exceed International Standards like DIN, ISO, ASTM, IS, BS etc. We have expertise not only in standard products, but also in made-to-order customized products.

Specialized Coatings

We excel in a variety of coatings, which are done in-house. These are designed to provide required protection in different environments, e.g. Hot Dip Galvanizing, Mechanical Galvanizing, Electroplating (Zinc & Copper Cadmium), PTFE Coating, Zinc-Al Flake Coating (Geomet, Delta Protekt) and Unbrako Wiscoat Coating.



Specialized Coatings

A Product's lifespan and performance is not only measured by it's quality, grade and and specification, but also by it's surface finish. Choosing the correct coating for the application will prevent corrosion, enhance aesthetic value and add strength to the fastener, extending it's life and performance.

Unbrako excels in a variety of coatings done in-house, designed specifically to provide the required protection in such harsh environment. Technical information of a few of these coatings is set out below:

MAIN COATINGS		ELECTROLYTIC COATINGS ZINC CADMIUM	HOT-DIP GALVANISATION	METALLIC COATING ZINC FLAKE	PTFE
Type of material		All metals	Steels	All metals	All metals
Process temperature		Bath t° < 90°C Baking temp. < 250°C	460°C - 550°C	20°C Process 300°C Baking	300°C Baking
Maximum service temperature without damage of coating		Zinc : 250°C Max Cadmium : 235°C Max chromating Zinc & Cadmium : 70°C max	300°C max	280°C max	280°C max
Usual thickness		Cadmium : 3 µm to 20 µm	Individual - 43µm Average - 54µm	5 µm - 15 µm	10 µm - 20 µm
Average Friction Coefficient	without lubrication	0.16 - 0.22	Seizure risks when bolt stress is >40% YS	0.15 - 0.25	0.15 - 0.25
	with lubrication	0.08 - 0.12	0.13 - 0.18	0.08 - 0.12	0.08 - 0.12
Salt spray test (red corrosion)		Zinc 5 to 7µm : 48 h min Zinc chromating 5 to 7 µm : 96 h min Reinforced chromating : 200 h min	70µm : 400 h min	5-7 µm : 400h min 8-10 µm: 1000h min	1000h min
Hydrogen embrittlement		Descaling with inhibitor imperative baking for 100 Mpa steels	Descaling with inhibitor No risk process	No risk process	No risk process
Aspect		Bright	Matt or glossy	Matt aluminum	Matt Blue

NOTE:- Specialist assistance is recommended when selecting these coatings.

Quality Standards

1. Company Approvals:

Unbrako manufacturing facilities are approved to
BS EN ISO 9001:2008
ISO/TS 16949:2009
BS OHSAS 18001:2007
ISO/TS 14001:2004
ISO 9001:2008
EN 14399 & 15048

2. Quality Levels:

2.1 Final acceptance of a consignment is determined by applying attribute sampling plans as defined in BS 6001 Double sampling tables Level 1 (Normal Inspection).

2.2 Acceptance Levels are as follows :

- 2.2.1 Major Characteristics 1.5% A.Q.L.
- 2.2.2 Minor (A) Characteristics 2.5% A.Q.L.
- 2.2.3 Incidental (Minor B) Characteristics 4.0% A.Q.L.
- 2.2.4 A.Q.L. for characteristics identified as critical by the user will be established by negotiation.
- 2.2.5 Zero acceptance for mixed, scrap or mutilated parts (100% sort).

2.3 The following identifies the characteristics classified as Major, Minor (A) and Incidental (Minor B).

2.3.1 Major

- i. Thread conformance
- ii. Dimensions with a tolerance equal to or less than 0.002" total.
- iii. Angles with a tolerance equal to or less than 1° total.
- iv. Surface texture equal to or less than 16 CLA.
- v. Post Heat Treatment physical testing.
- vi. Surface discontinuities.
- vii. Straightness
- viii. Concentricity e.g. Head/Shank/Thread.
- ix. Underhead fillet area / bearing surface squareness.
- x. Thread run-out.
- xi. Hexagon Socket.
- xii. Grip Length.

2.3.2 Minor (A)

- i. Dimensions with a tolerance greater than 0.002" but not exceeding 0.008".
- ii. Angles with a tolerance varying from 1° up to and including 5°.
- iii. Surface texture greater than 16 CLA and equal to or less than 32 CLA.
- iv. Identification.
- v. Burrs and tool marks.

2.3.3 Incidental (Minor B)

- i. Dimensions with a tolerance greater than 0.008" total.
- ii. Angles with a tolerance greater than 5° total.
- iii. Surface texture greater than 32 CLA.
- iv. Visual characteristics.

3. Certifications:

Unbrako Standard Socket screw products carry a Certificate of Conformity on each and every box, incorporating a lot traceable number, free of charge.

In addition Socket Head Cap Screws greater than and equal to ¼" and M5 have an e-code identifier stamped on the head of each part, allowing traceability even when the original box and label is not available.

Additionally, the following test certificates are available, subject to extra charge:

- i. To DIN 50049 2.1 (EN10204 TYPE 2.1 CERT)
- ii. To DIN 50049 2.2 (EN 10204 TYPE 2.2 CERT)
- iii. To DIN 50049 2.3 (EN 10204 TYPE 2.2 CERT)
- iv. To DIN 50049 3.1A (EN 10204 TYPE 3.1 CERT)
- v. To DIN 50049 3.1B (EN 10204 TYPE 3.1 CERT)
- vi. To DIN 50049 3.1C (EN 10204 TYPE 3.2 CERT)

Product Terminology

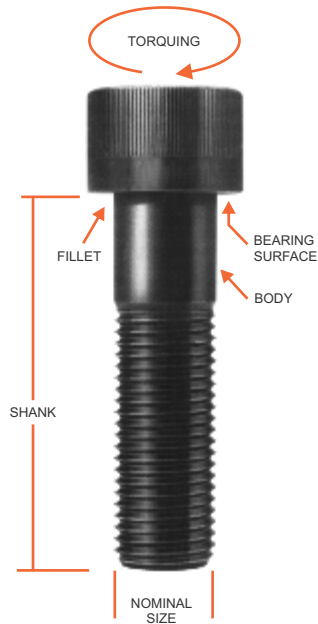

BODY
The unthreaded portion of the shank of a threaded fastener.

FILLET
Concave junction between the head and shank.

HEAD
A headed fastener has one end enlarged into a preformed shape.

LENGTH
The length of a headed fastener is the distance from intersection between the bearing surface & the largest diameter to the extreme end of the fastener, measured parallel to the axis of the fastener. The length of a headless fastener is the distance from one extreme end to the other end, also measured parallel to the fastener.

NOMINAL SIZE
It is the basic major diameter of the thread.

SHANK
The portion of a headed fastener which lies between the head and the extreme end of the fastener.

TORQUING
It is the act of tightening a fastener by turning either the bolt or nut.

Thread Terminology

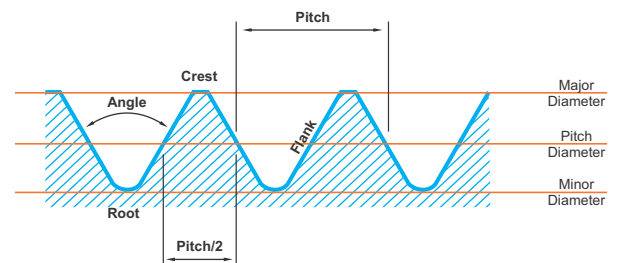

CREST
The outermost tip of a male thread as seen in a thread profile.

FLANK
The thread surface connecting the crest with the root.

BEARING SURFACE
The supporting or locating surface of a fastener with respect to the part it fastens or mates.

MAJOR DIAMETER
The largest diameter of a thread.

MINOR DIAMETER
The smallest diameter of a thread.

PITCH
The distance from a point on a screw thread to the corresponding point on the next screw thread.

PITCH DIAMETER
Is the diameter of a theoretical cylinder that passes through the threads at a position that the width of thread ridge and thread groove are equal.

ROOT
The bottom area between the sides of two adjacent threads.



Thread Terminology

THREAD LAPS

Are surface defects caused by the folding over of metal in the thread.



THREAD RUNOUT

is the area between the thread and shank or head of the fasteners. The Unbrako radiused root runout provides a smooth form that distributes stress and increases the life of the fastener considerably.

THREAD STRESS AREA

The area of a cylindrical bar of the same material and properties as the thread and capable of supporting the same ultimate tensile load.

Mechanical Terminology

CREEP

Deformation that occurs over a period of time when a fastener is subjected to a constant stress at a constant high temperature.



ELONGATION

is the increase in the thread length or a fastener that would occur during tightening or loading.



ENDURANCE LIMIT

The strength level below which a bolt or joint member will have an essentially infinite life under cyclic loading.

FATIGUE LIFE

is the number of cycles of fluctuating stress and strain of a specified nature that a fastener will sustain before failure occurs.



IMPACT TEST

A test to determine the energy absorbed in fracturing a test bar at high velocity.

PROOF LOAD

is a specified test load which a fastener must withstand without any indication of failure.

PROOF TEST

is any specified test required for a fastener to indicate that is suitable for the purpose intended.

ROCKWELL HARDNESS (Hrc)

This is a specific method of measuring the hardness of a fastener. The "c" denotes a specific size indenter which penetrates the surface of the prepared specimen.

SHEAR JOINT

A joint in which the fastener has the load applied across the axis and which tends to sever it.

SHEAR STRENGTH

This is the maximum strength of the fastener when it is subjected to shear (transverse) loading.



TENSILE STRENGTH

Is the force or stress required to break a fastener when the force or stress is applied in straight tension.



TENSION JOINT

A joint in which the fastener has the load applied to the longitudinal direction and which tends to elongate it.

TORSION

is the twisting force applied to a fastener during tightening.

YIELD STRENGTH

This is the maximum force or stress that can be applied to a fastener without permanent (plastic) deformation occurring.

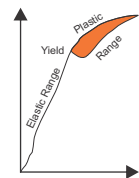

Influence of Chemicals in Steel



Steel alloys using different chemical elements are produced in order to improve the physical properties of the material and to achieve special properties:

Carbon (C)

Although this is not considered to be an alloying element, it is the most important component in steel. It improves tensile strength, hardness and abrasion resistance. It reduces ductility, rigidity and machining.

Manganese (Mn)

This is an oxidiser and degasifier and reacts with sulphur to improve forgeability. It increases tensile strength, hardness and durability.

Phosphorus (P)

This increases tensile strength and hardness and improves machinability. It causes fragility in steel.

Sulphur (S)

Improves machining qualities in the presence of manganese. It reduces weldability, impact, roughness, and ductility.

Silicon (Si)

This is a deoxidiser and degasifier. It increases tensile strength, elasticity, hardness and forgeability.

Chromium (Cr)

Increase breaking strength, hardness, durability, roughness, and resistance to high temperatures.

Nickel (Ni)

This raises strength and hardness, while maintaining ductility and rigidity. It increases resistance to cracking and high temperatures.

Molybdenum (Mo)

This increases strength, hardness, durability, and rigidity, together with resistance to cracking & to high temperatures.

Titanium (Ti)

This is used as a stabilising element in stainless steels. It has a great affinity for carbon.

Socket Screws

Page	Contents
16	Socket Head Cap Screws
22	Socket Head Cap Screws - 1960 series
31	Socket Low Head Cap Screws
35	Socket Head Shoulder Screw
40	Countersunk Socket Screws (Flat Head)
48	Button Head Cap Screws
53	Flange Button Head Cap Screws
60	Socket Set Screws
74	Taper Pressure Plugs



High-performance Socket Screws



Why Socket Screws? Why Unbrako?

The most important reasons for the increasing use of socket head cap screws in industry are safety, reliability and economy. All three reasons are directly traceable to the superior performance of socket screws vs. other fasteners due to their superior strength and advanced design.

Reliability, higher pressures, stresses and speeds in today's machines and equipment demand stronger, more reliable fasteners to hold them together.

Rising costs make failure and downtime intolerable. Bigger, more complex units break down more frequently despite every effort to prevent it.

This is why the reliability of every component has become critical. Components must stay together to function properly, and to keep them together joints must stay tight.

Unbrako developed the first internal hex socket screw and is the world's leading socket screw brand with more than 100 years' experience of supplying to the high-end industries, such as the automotive, infrastructure, aerospace, petrochemical, heavy machinery and military sectors.

UNBRAKO socket cap screws offer joint reliability, safety with maximum strength and fatigue resistance greater than any other threaded fastener.

Higher Tensile Strength

Unbrako 12.9 metric alloy steel socket head cap screws are manufactured to strength levels of 1300/1250 MPa (depending on dia) compared to the industry standard of 1220 MPa. For inch sizes, Unbrako manufactures to 190/180 Ksi compared to the industry standard per ASTM A574 of 180/170 Ksi.

This higher tensile strength can be translated into savings. Fewer socket screws

of the same size can be used to achieve the same clamping force in the joint. A joint requiring 12 x 1-3/8" Grade 5 hex heads would need only 7 UNBRAKO socket head cap screws. Thus, there are fewer holes to drill & tap, fewer screws to buy & handle.

Using smaller diameter socket head cap screws vs. larger hex screws costs less to drill and tap, need less space, require no additional wrench space, take less energy to drive, and there is also weight saving.

Greater Fatigue Strength

Joints that are subject to external stress loading are susceptible to fatigue failure. UNBRAKO socket screws have distinct advantages that give you an extra bonus of protection against this hazard, namely - design improvements, mechanical properties & closely controlled manufacturing processes.

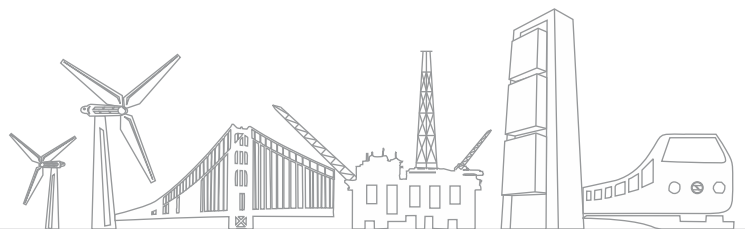

High-performance Socket Screws

Head with increased bearing area for greater load carrying capability. Precision forged for symmetrical grain flow, maximum strength.

Specially designed Elliptical fillet doubles fatigue life at critical head-shank juncture.

"3-R" (radiused-root runout) increases fatigue life at this critical juncture.

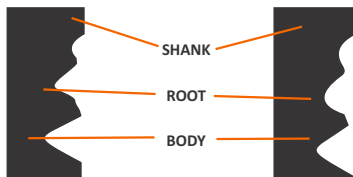

CONVENTIONAL THREAD RUNOUT - Note sharp angle at root where high stress concentration soon develops crack which penetrates into body of the screw.

UNBRAKO "3-R" (Radiused Root Runout) THREAD - Controlled radius of runout root provides a smooth form that distributes stress and increases fatigue life of thread run-out as much as 300% in certain sizes.

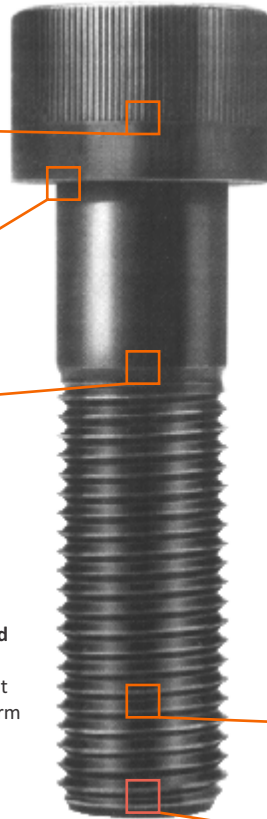

Total Traceability: Patented E-CODE™ head marking system allows tracing of test records to specific production batches



Deep, accurate socket for high torque wrenching. Knurls for easier handling. Marked for easier identification.

Fully formed radiused thread increases fatigue life 100% over flat root thread forms.

Controlled heat treatment produces maximum strength without brittleness and decarburization

Unbrako Socket Products		Application / Features	
Socket Head Cap Screws Alloy / Stainless			Suitable for all high tensile applications. Up to 190,000 psi/ 1300 Mpa– highest of any socket cap screw. Use Stainless for corrosive, cryogenic or elevated temperature environment.
Socket Head Cap Screws Low Head Series Alloy / Stainless			Suitable for use in parts too thin for standard Socket Head Cap Screw and for applications with limited clearance.
Socket Set Screws (Grub Screws) Alloy / Stainless			Fasten collars, sheaves, gears, knobs on shafts. Locate machine parts. Self-locking knurled cup point is standard. Special Points like Flat, Dog, Cone & Plain Cup are also available.
Shoulder Screws			Replaces costly special parts – shafts, pivots, pins, guides, linkages and trunnion mountings. Also standard for tool and die industries.
Button Head Cap Screws Alloy / Stainless			Low head streamline design. Use them in materials too thin to countersink; also for non-critical loading requiring heat treated screws
Flat Head Countersunk Socket Screws Alloy / Stainless			Controlled angle under the head ensures maximum flushness and side wall contact. Non-slip Hex socket prevents marring of material.

Socket Head Cap Screws Micro Series - M1.4 to M2.6

Metric



Suitable for all high tensile applications.
Up to 1300 Mpa– highest of any socket cap screw.

Equivalent Standards

ISO 4762, DIN 912, ASME B18.3.1M
BS 4168-1

Mechanical Properties

Screw Size	≤M16	>M16
Heat Treatment	40-43 HRC	40-43 HRC
Tensile Strength	1300 N/mm ²	1250 N/mm ²
Yield Strength	1170 N/mm ²	1124 N/mm ²
Shear Strength	780 N/mm ²	750 N/mm ²
Min. Elongation	9%	9%

Notes:

- Property Class : 12.9
- Thread Class : 4g6g
- Working Temperature : -50°C to +300°C
- Torques calculated in accordance with VDI 2230 "Systematic calculation of high duty bolted joints" with $\sigma_{0.2} = 1080 \text{ N/mm}^2$ and $\mu = 0.125$ for plain finish and $\mu = 0.094$ for plated.

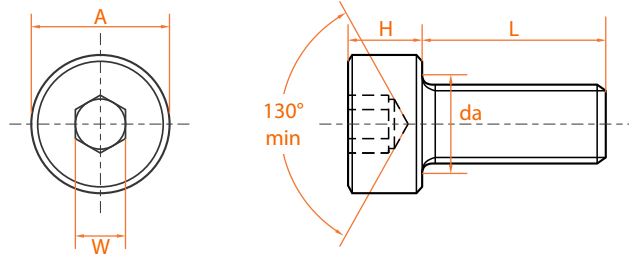

Product Dimensions (Micro Sizes)

Thread Size	Pitch	Head Diameter	Hex Socket Size	Head Height	Transition Dia	Length	
		A max	W nom	H max	da nom	L min	L max
M1.4	0.30	2.6	1.27	1.4	1.8	3	6
M1.6	0.35	3.0	1.50	1.6	2.0	3	6
(M1.7)	0.35	3.0	1.50	1.7	2.1	3	6
M1.8	0.35	3.4	1.50	1.8	2.3	3	6
M2	0.40	3.8	1.50	2.0	2.6	3	12
(M2.3)	0.40	4.0	2.00	2.3	2.9	4	15
M2.5	0.45	4.5	2.00	2.5	3.1	4	15
(M2.6)	0.45	4.5	2.00	2.6	3.2	4	15

Thread Size	Recommended Torques Setting					
	Unplated		Plated		Induced Load	
	Nm	lbf.in	Nm	lbf.in	kN	lbf
M1.4	0.20	1.8	0.15	1.3	733	164
M1.6	0.29	2.6	0.22	2.0	930	208
(M1.7)	0.35	3.1	0.26	2.3	1,100	246
M1.8	0.44	3.9	0.33	2.9	1,300	291
M2	0.60	5.3	0.45	4.0	1,550	347
(M2.3)	0.95	8.4	0.71	6.3	2,230	500
M2.5	1.21	10.7	0.90	8.0	2,590	580
(M2.6)	1.37	12.1	1.03	9.1	2,860	640

Sizes in brackets are non-preferred standards

Socket Head Cap Screws M3 to M48

Metric



Suitable for all high tensile applications. Up to 1300 Mpa– highest of any socket cap screw. Use Stainless for corrosive, cryogenic or elevated temperature environments.

Equivalent Standards

ISO 4762, DIN 912, ASME B18.3.1M
BS 4168-1

Mechanical Properties

Screw Size	≤M16	>M16
Heat Treatment	40-43 HRC	40-43 HRC
Tensile Strength	1300 N/mm ²	1250 N/mm ²
Yield Strength	1170 N/mm ²	1124 N/mm ²
Shear Strength	780 N/mm ²	750 N/mm ²
Min. Elongation	9%	9%

Notes:

1. Screws with lengths equal to or shorter than listed in column 'L' are threaded to head.
2. Property Class : 12.9
3. Thread Class : 4g6g
4. Working Temperature : -50°C to +300°C

5. Torques calculated in accordance with VDI 2230 "Systematic calculation of high duty bolted joints" with $\sigma_{0.2} = 1080 \text{ N/mm}^2$ and $\mu = 0.125$ for plain finish and $\mu = 0.094$ for plated.

Head Marking



- 'X' represents Lot Traceability E-CODE
- For Sizes M5 or Larger

Unbrako

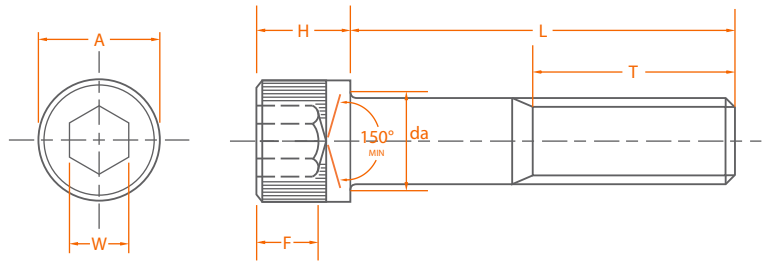

Product Dimensions (Standard Sizes)

Thread Size nom.	Pitch	Head Diameter A max	Hex Socket Size W nom.	Head Height H max	Socket Depth F min.	Transition Dia da max	Length L Note 1	Thread Length T ref.
M3	0.50	5.5	2.5	3.0	1.3	3.60	20	18
M4	0.70	7.0	3.0	4.0	2.0	4.70	25	20
M5	0.80	8.5	4.0	5.0	2.5	5.70	25	22
M6	1.00	10.0	5.0	6.0	3.0	6.80	30	24
M8	1.25	13.0	6.0	8.0	4.0	9.20	35	28
M10	1.50	16.0	8.0	10.0	5.0	11.20	40	32
M12	1.75	18.0	10.0	12.0	6.0	13.70	50	36
(M14)	2.00	21.0	12.0	14.0	7.0	15.70	55	40
M16	2.00	24.0	14.0	16.0	8.0	17.70	60	44
(M18)	2.50	27.0	14.0	18.0	9.0	20.20	65	48
M20	2.50	30.0	17.0	20.0	10.0	22.40	70	52
(M22)	2.50	33.0	17.0	22.0	11.0	24.40	70	56
M24	3.00	36.0	19.0	24.0	12.0	26.40	80	60
M27	3.00	40.0	19.0	27.0	13.5	30.40	90	66
M30	3.50	45.0	22.0	30.0	15.5	33.40	100	72
M33	3.50	50.0	24.0	33.0	18.0	36.40	100	78
M36	4.00	54.0	27.0	36.0	19.0	39.40	110	84
M42	4.50	63.0	32.0	42.0	24.0	45.60	130	96

Thread Size nom.	Recommended Torques Setting				Induced Load	
	Unplated		Plated		kN	lbf
	N-m	in-lbs.	N-m	in-lbs.		
M3	2.1	18.6	1.6	14.2	3.99	890
M4	4.6	40.7	3.5	31.0	6.75	1,510
M5	9.5	84.1	7.1	62.8	11.10	2,480
M6	16.0	142.0	12.0	106.0	15.60	3,480
M8	39.0	345.0	29.0	257.0	28.70	6,400
M10	77.0	682.0	58.0	513.0	45.70	10,200
M12	135.0	1,200.0	101.0	894.0	66.70	14,900
(M14)	215.0	1,900.0	161.0	1,420.0	91.30	20,400
M16	330.0	2,920.0	248.0	2,190.0	126.00	28,100
(M18)	455.0	4,030.0	341.0	3,020.0	153.00	34,100
M20	650.0	5,750.0	488.0	4,320.0	197.00	44,000
(M22)	870.0	7,700.0	652.0	5,770.0	245.00	54,700
M24	1,100.0	9,740.0	825.0	7,300.0	284.00	63,400
M27	1,650.0	14,600.0	1,238.0	11,000.0	374.00	83,400
M30	2,250.0	19,900.0	1,688.0	15,000.0	454.00	101,000
M33	3,050.0	27,000.0	2,287.0	20,200.0	550.00	123,000
M36	3,850.0	34,100.0	2,888.0	25,000.0	664.00	148,000
M42	6,270.0	55,500.0	4,700.0	41,600.0	889.00	198,000

Sizes in brackets are non-preferred standards

Body and Grip Length Dimensions

- LG is the maximum grip length and is the distance from the bearing surface to the first complete thread.
- LB is the minimum body length and is the length of the unthreaded cylindrical portion of the shank.
- Dimensions for LB and LG are calculated from the following formula:

T Ref = (2x Nominal Dia) plus 12mm.

LG max = Nominal length "L" minus "T"

LB min = Nominal length "L" minus (T + 5 pitches)

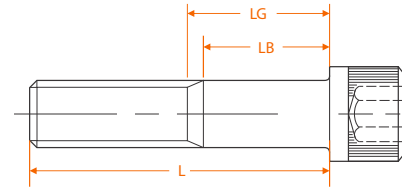

Length	M3		M4		M5		M6		M8		M10		M12		M14		M16	
L Nom.	LB (Min.)	LG (Max.)	LB (Min.)	LG (Max.)	LB (Min.)	LG (Max.)	LB (Min.)	LG (Max.)	LB (Min.)	LG (Max.)	LB (Min.)	LG (Max.)	LB (Min.)	LG (Max.)	LB (Min.)	LG (Max.)	LB (Min.)	LG (Max.)
25	4.5	7																
30	9.5	12	6.5	10	4	8												
35			11.5	15	9	13	6	11										
40			16.5	20	14	18	11	16	5.75	12								
45					19	23	16	21	10.75	17	5.5	13						
50					24	28	21	26	15.75	22	10.5	18						
55							26	31	20.75	27	15.5	23	10.25	19				
60							31	36	25.75	32	20.5	28	15.25	24	10	20		
65									30.75	37	25.5	33	20.25	29	15	25	11	21
70									35.75	42	30.5	38	25.25	34	20	30	16	26
80									45.75	52	40.5	48	35.25	44	30	40	26	36
90											50.5	58	45.25	54	40	50	36	46
100											60.5	68	55.25	64	50	60	46	56
110													65.25	74	60	70	56	66
120													75.25	84	70	80	66	76
130															80	90	76	86
140															90	100	86	96
150																	96	106
160																	106	116
180																		

Length 'L' Tolerance (mm)

Screws Over	Up to and including	Tolerance
-	50	±0.25
50	80	±0.50
80	120	±0.71
120	250	±0.79
250	-	±1.02

Length	M18		M20		M22		M24		M27		M30		M33		M36		M42	
Nom.	LB (Min.)	LG (Max.)	LB (Min.)	LG (Max.)	LB (Min.)	LG (Max.)	LB (Min.)	LG (Max.)	LB (Min.)	LG (Max.)	LB (Min.)	LG (Max.)	LB (Min.)	LG (Max.)	LB (Min.)	LG (Max.)	LB (Min.)	LG (Max.)
70	9.5	22																
80	19.5	32	15.5	28	11.5	24												
90	29.5	42	25.5	38	21.5	34	15	30										
100	39.5	52	35.5	48	31.5	44	25	40	19	34								
110	49.5	62	45.5	58	41.5	54	35	50	29	44	20.5	38	14.5	32				
120	59.5	72	55.5	68	51.5	64	45	60	39	54	30.5	48	24.5	42	16	36		
130	69.5	82	65.5	78	61.5	74	55	70	49	64	40.5	58	34.5	52	26	46		
140	79.5	92	75.5	88	71.5	84	65	80	59	74	50.5	68	44.5	62	36	56	21.5	44
150	89.5	102	85.5	98	81.5	94	75	90	69	84	60.5	78	54.5	72	46	66	31.5	54
160	99.5	112	95.5	108	91.5	104	85	100	79	94	70.5	88	64.5	82	56	76	41.5	64
180	119.5	132	115.5	128	111.5	124	105	120	99	114	90.5	108	84.5	102	76	96	61.5	84
200			135.5	148	131.5	144	125	140	119	134	110.5	128	104.5	122	96	116	81.5	104
220					151.5	164	145	160	139	154	130.5	148	124.5	142	116	136	101.5	124
240							165	180	159	174	150.5	168	144.5	162	136	156	121.5	144
260									179	194	170.5	188	164.5	182	156	176	141.5	164
280											190.5	208	184.5	202	176	196	161.5	184

All dimensions are in mm.

Socket Head Cap Screws - Metric



Size	Part No.		lbs. /1000
M1.6 (0.35) - Key Size 1.5mm			
M1.6 x 4	104138	200	0.22
6	104150	200	0.28
M2 (0.4) - Key Size 1.5mm			
M2 x 3	104151	200	0.44
4	104152	200	0.48
5	104154	200	0.53
6	104155	200	0.57
8	104157	200	0.64
10	104159	200	0.73
12	106216	200	0.81
M2.5 (0.45) - Key Size 2mm			
M2.5 x 5	104161	200	0.77
6	104162	200	0.95
8	104163	200	1.08
10	104164	200	1.21
12	104166	200	1.32
M3 (0.5) - Key Size 2.5mm			
M3 x 5	106218	200	1.50
6	103002	200	1.58
10	113583	200	1.96
12	120870	200	2.13
14	400509	200	2.33
15	400506	200	2.42
16	103003	200	2.51
20	113623	200	2.88
25	103010	200	3.34
30	103013	200	3.94
35	106219	200	4.51
M4 (0.7) - Key Size 3mm			
M4 x 5	106220	200	3.06
6	106223	200	3.21
8	113810	200	3.54
10	113839	200	3.87
12	121077	200	4.22
14	400568	200	4.53
15	400511	200	4.58
16	103014	200	4.86
18	103015	200	5.21
20	125753	200	5.54
22	400521	200	5.87
25	125381	200	6.36
30	103018	200	7.39
35	103019	200	8.43
40	103021	200	9.46

Size	Part No.		lbs. /1000
M4 (0.7) - Key Size 3mm			
M4 x 45	103022	200	10.49
50	103023	200	11.53
M5 (0.8) - Key Size 4mm			
M5 x 10	122243	200	6.69
12	121094	200	7.22
14	400513	200	7.74
15	400510	200	8.03
16	103024	200	8.29
18	400522	200	8.82
20	113970	200	9.35
22	400523	200	9.88
25	121096	200	10.67
30	103029	200	12.32
35	115292	200	13.95
40	103030	200	15.58
45	103031	200	17.20
50	103035	200	18.83
55	103038	200	20.48
60	103040	200	22.11
65	106225	200	23.74
70	106228	200	25.37
M6 (1) - Key Size 5mm			
M6 x 8	103042	200	9.57
10	122111	200	10.32
12	120872	200	11.07
14	400567	200	11.84
15	400512	200	11.84
16	103044	200	12.21
18	103045	200	13.35
20	119790	200	14.15
22	103046	200	14.85
25	119937	200	16.04
30	122121	200	17.93
35	121090	200	20.61
40	121075	200	22.99
45	122087	200	25.37
50	112624	200	27.74
55	113128	200	30.10
60	122088	200	32.47
65	103047	200	34.85
70	103048	200	37.20
75	103049	200	39.58
80	103051	200	41.95
90	103052	200	46.68
100	103053	200	51.41

Size	Part No.		lbs. /1000
M6 (1) - Key Size 5mm			
M6 x 110	103054	200	55.73
120	103055	200	60.46
M8 (1.25) - Key Size 6mm			
M8 x 10	103056	200	22.31
12	114972	200	23.61
14	400524	200	24.99
15	400514	200	25.74
16	103058	200	26.42
18	400569	200	27.81
20	122086	200	29.19
22	120642	200	30.49
25	119351	200	32.63
30	119383	200	36.08
35	122113	200	39.51
40	113143	200	43.65
45	121076	200	48.55
50	121068	100	52.07
55	103063	100	56.30
60	121070	100	60.50
65	103064	100	65.45
70	103066	100	69.67
75	103069	100	73.90
80	103070	100	78.12
90	103073	100	86.55
100	103075	100	94.60
110	103076	100	103.44
120	103077	100	111.89
130	106230	100	120.34
140	106231	100	127.95
150	106232	100	143.00
160	106233	50	144.83
180	106234	50	162.56
200	106235	50	179.43
M10 (1.5) - Key Size 8mm			
M10 x 10	106236	200	39.34
12	106237	200	41.65
15	400525	200	44.75
16	103080	200	45.83
18	400526	200	48.00
20	113163	200	50.16
25	115060	200	55.57
30	122114	200	61.23
35	113257	200	86.37
40	100845	100	72.09
45	121088	100	78.45
50	125660	100	85.07



Sizes above the bold line are threaded to head.
Property Class: 12.9

Socket Head Cap Screws - Metric



HIGH-GRADE ALLOY STEEL

Size	Part No.		lbs. /1000
M10 (1.5) - Key Size 8mm			
M10 x 55	103087	100	93.02
60	122217	100	98.32
65	103088	100	104.94
70	125786	100	112.90
75	103090	100	119.55
80	103091	100	126.17
90	103094	50	126.48
100	103095	50	137.35
110	103096	50	164.56
120	103097	50	179.26
130	106240	50	192.52
140	106241	50	212.08
150	106242	50	225.94
160	106243	50	239.80
180	106244	50	258.85
200	106245	50	285.38
220	400517	25	311.92
M12 (1.75) - Key Size 10mm			
M12 x 12	106246	100	60.24
16	106247	100	66.53
20	112607	100	72.82
25	122250	100	80.67
30	122251	100	88.55
35	125530	100	96.40
40	114996	50	104.28
45	115075	50	112.13
50	112360	50	119.90
55	122255	50	129.58
60	122260	50	139.48
65	122261	50	152.13
70	103098	50	158.14
75	103099	50	171.23
80	103100	50	180.77
90	103103	50	196.26
100	122142	50	218.97
110	125791	50	238.06
120	103104	50	253.48
130	103107	50	272.54
140	103108	50	291.61
150	103110	50	310.68
160	107456	50	334.40
180	107458	50	367.88
200	107459	50	406.01
260	400572	25	524.48
M14 (2) - Key Size 12mm			
M14 x 25	400528	50	118.82
30	400529	50	129.60

Size	Part No.		lbs. /1000
M14 (2) - Key Size 12mm			
M14 x 35	400530	50	140.36
40	400531	50	151.14
45	400532	50	161.90
50	120863	50	172.68
55	400533	50	183.46
60	112000	50	196.48
65	400534	50	209.48
70	400535	50	227.46
75	400536	50	235.53
80	400537	50	248.56
90	400538	50	274.58
100	400539	50	300.63
110	400540	50	326.66
120	400508	50	352.10
M16 (2) - Key Size 14mm			
M16 x 25	106248	25	169.7
30	103112	25	184.1
35	103113	25	199.1
40	125751	25	213.6
45	103115	25	228.1
50	112474	25	242.0
55	103117	25	256.5
60	112594	25	271.0
65	103118	25	288.0
70	103119	25	305.0
75	103120	25	322.1
80	125658	25	339.2
90	103122	25	371.8
100	103123	25	407.3
110	103124	25	441.4
120	103126	25	475.5
130	103127	25	509.6
140	103128	25	541.2
150	103129	25	577.8
160	103364	25	609.4
180	107460	25	679.1
200	107448	25	748.2
300	400578	5	1096.5
M18 (2.5) - Key Size 14mm			
M18 x 35	400541	25	272.8
40	400542	25	290.8
45	400606	25	308.8
50	100844	25	326.0
60	400544	25	362.9
65	400545	25	380.9
70	400546	25	402.6
80	400549	25	445.7

Size	Part No.		lbs. /1000
M18 (2.5) - Key Size 14mm			
M18 x 90	400550	25	486.6
100	400551	25	532.2
120	400552	25	618.6
M20 (2.5) - Key Size 17mm			
M20 x 30	107465	25	329.4
35	107466	25	352.1
40	103130	25	374.7
45	103131	25	397.3
50	103132	25	420.0
55	103136	25	442.7
60	103137	25	465.3
65	103138	25	487.9
70	103141	25	510.6
75	103142	25	537.3
80	103143	25	563.9
90	103144	25	617.2
100	103145	25	670.5
110	103146	25	723.8
120	103148	25	777.1
130	103150	10	826.8
140	103151	10	880.0
150	103152	10	934.3
160	107462	10	990.2
180	107463	10	1096.8
200	107464	5	1203.3
220	400553	5	1321.5
240	400554	5	1428.2
260	400555	5	1534.9
280	400556	5	1641.9
300	400557	5	1748.4
340	796973	5	1960.30
M22 (2.5) - Key Size 17mm			
M22 x 80	180186	10	739.2
90	180187	10	805.2
100	180188	10	871.2
110	180189	10	937.2
140	180192	10	1135.2
M24 (3) - Key Size 19mm			
M24 x 40	106249	10	594.0
45	103153	10	627.0
50	103155	10	672.7
55	103157	10	705.7
60	103158	10	738.1
65	103159	10	770.7
70	103160	10	801.8
75	103161	10	836.0
80	103162	10	868.7



Size	Part No.		lbs. /1000
M24 (3) - Key Size 19mm			
M24 x 90	103163	10	960.4
100	103165	10	1034.0
110	103166	10	1114.5
120	103167	10	1188.0
130	103168	10	1268.0
140	103170	10	1353.0
150	103171	10	1405.6
160	104143	10	1482.6
180	104146	10	1636.5
200	104147	5	1808.1
220	400560	5	1962.2
240	400561	5	2116.3
260	400562	5	2270.4
280	400563	1	2578.6
300	400564	1	2728.0
M30 (3.5) - Key Size 22mm			
M30 x 70	116464	1	1419.8
80	140610	1	1518.0
90	140611	1	1621.7
100	140612	1	1724.0
110	140613	1	1881.0
120	140614	1	2004.7
130	140615	1	2125.5
140	140616	1	2244.0
150	140617	1	2366.0
160	140618	1	2486.0
180	140620	1	2728.0
200	140621	1	2970.0
280	140625	1	3936.5
300	400626	1	4177.9
320	180848	1	4419.8
M36 (4) - Key Size 27mm			
M36 x 80	140629	1	2388.9
90	140630	1	2530.0
100	140631	1	2681.1
120	140633	1	3055.0
130	400634	1	3229.5
140	140635	1	3351.3
150	140636	1	3577.3
160	140637	1	3751.3
180	140639	1	4098.9
200	140640	1	4466.0
220	180294	1	4794.5
240	140641	1	5142.3
260	140642	1	5490.1
280	180411	1	5837.9
300	140643	1	6185.6
320	180490	1	6533.4

Sizes above the bold line are threaded to head.
Property Class: 12.9

Threaded to Head

Size	Part No.		lbs. /1000
M5 (0.8) - Key Size 4mm			
M5 x 30	400583	200	12.32
35	400584	200	13.95
40	400585	200	15.58
50	400587	200	18.83
M6 (1) - Key Size 5mm			
M6 x 35	400589	200	20.68
40	400590	200	21.71
50	400591	200	25.50
60	400592	200	29.28
M8 (1.25) - Key Size 6mm			
M8 x 40	400593	100	42.97
50	400594	100	49.83
60	400595	100	56.72
70	406180	100	69.52
80	406181	100	70.49
M10 (1.5) - Key Size 8mm			
M10 x 50	400597	100	86.68
60	400598	100	99.88
70	400599	100	113.08
80	400600	100	115.59

Deal with CORROSION The Intelligent Way!

**Check out a host of coatings
available from Unbrako:**

- Zinc Electroplating
- Mechanical Galvanizing
- Hot Dip Galvanizing
- Zinc-Al Flake
- Unbrako Wiscoat
- PTFE



Socket Head Cap Screws - 1960 series

#0 to 1/2 - UNRC/UNRF

Inch



Suitable for all high tensile applications. Up to 190,000 psi highest of any socket cap screw. Use Stainless for corrosive, cryogenic or elevated temperature environments.

Equivalent Standards

ASME B18.3

Mechanical Properties

Screw Size	≥ 1/2	< 1/2
Heat Treatment	39-43 RC	39-43 RC
Tensile Strength	190 ksi	180 ksi
Yield Strength	170 ksi	162 ksi
Shear Strength	114 ksi	108 ksi

Material: Unbrako High Grade Alloy Steel

Elongation is 2 inches - 10% min.

Reduction of area - 35% min.

Length 'L' Tolerance (in)

Diameter	up to 1" incl.	over 1" to 2 1/2"	over 2 1/2" to 6"
		incl.	incl.
#0 thru 3/8 incl.	-.03	-.04	-.06
7/16 to 3/4 incl.	-.03	-.06	-.08
7/8 to 1-1/2 incl.	-.05	-.10	-.14
over 1 1/2		-.18	-.24

NOTES:

1. Thread Class: #0 to 1": 3A, over 1": 2A
2. Working Temperature: -50°C to +300°C
3. Torques calculated in accordance with VDI 2230 "Systematic calculation of high duty bolted joints" with $\sigma 0.2 = 155$ K.S.I. and $\mu = 0.125$ for plain finish and $\mu = 0.094$ for plated. Above 0.625" dia. $\sigma 0.2 = 140$ K.S.I.
4. The following diameters are fully interchangeable between 1936 and 1960 series:- No 10, 1/4", 3/8", 1/2" for both UNC and UNF

Head Marking

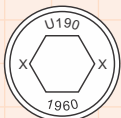

'X' represents Lot Traceability E-CODE

Unbrako

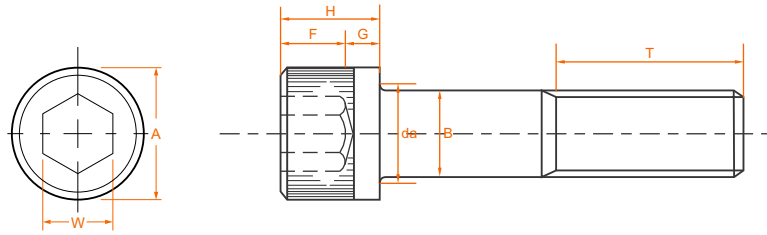

Product Dimensions

Thread Size	Threads per Inch		Head Diameter A		Hex Socket Size W	Head Height H		Key Depth F	Key Depth G	
	nom.	UNRC	UNRF	max	min	nom	max	min	min	
#0	-	80		.096	.091	.050	.060	.057	.025	.020
#1	64	72		.118	.112	.062	.073	.070	.031	.025
#2	56	64		.140	.134	.078	.086	.083	.038	.029
#3	48	56		.161	.154	.078	.099	.095	.044	.034
#4	40	48		.183	.176	.094	.112	.108	.051	.038
#5	40	44		.205	.198	.094	.125	.121	.057	.043
#6	32	40		.226	.218	.109	.138	.134	.064	.047
#8	32	36		.270	.262	.141	.164	.159	.077	.056
#10	24	32		.312	.303	.156	.190	.185	.090	.065
1/4	20	28		.375	.365	.188	.250	.244	.120	.095
5/16	18	24		.469	.457	.250	.312	.306	.151	.119
3/8	16	24		.562	.550	.312	.375	.368	.182	.143
7/16	14	20		.656	.642	.375	.437	.430	.213	.166
1/2	13	20		.750	.735	.375	.500	.492	.245	.190

Thread Size	Body Diameter B		Transition Diameter da		Thread Length T	Recommended seating torque (in-lbs)	
	max	min	max	min		UNRC	UNRF
#0	.060	.0568	.074	.051	.500	-	3
#1	.073	.0695	.087	.061	.625	5	5
#2	.086	.0822	.102	.073	.625	7	8
#3	.099	.0949	.115	.084	.625	12	13
#4	.112	.1075	.130	.094	.750	18	19
#5	.125	.1202	.145	.107	.750	24	25
#6	.138	.1329	.158	.116	.750	34	36
#8	.164	.1585	.188	.142	.875	59	60
#10	.190	.1840	.218	.160	.875	77	91
1/4	.250	.2435	.278	.215	1.000	200	240
5/16	.3125	.3053	.347	.273	1.125	425	475
3/8	.375	.3678	.415	.331	1.250	750	850
7/16	.4375	.4294	.484	.388	1.375	1,200	1,350
1/2	.500	.4919	.552	.446	1.500	1,850	2,150

Socket Head Cap Screws - 1960 series

5/8 to 3 - UNRC/UNRF

Inch



Suitable for all high tensile applications. Up to 190,000 psi highest of any socket cap screw. Use Stainless for corrosive, cryogenic or elevated temperature environments.

Equivalent Standards

ASME B18.3

Mechanical Properties

Screw Size	≥ 1/2	< 1/2
Heat Treatment	39-43 RC	39-43 RC
Tensile Strength	190 ksi	180 ksi
Yield Strength	170 ksi	162 ksi
Shear Strength	114 ksi	108 ksi

Material: Unbrako High Grade Alloy Steel

Elongation is 2 inches - 10% min.

Reduction of area - 35% min.

Length 'L' Tolerance (in)

Diameter	up to 1" incl.		over 1" to 2 1/2" incl.	over 2 1/2" to 6" incl.	over 6"
	#0 thru 3/8 incl.	-.03	-.04	-.06	-.12
7/16 to 3/4 incl.	-.03	-.06	-.08	-.12	
7/8 to 1-1/2 incl.	-.05	-.10	-.14	-.20	
over 1 1/2		-.18	-.20	-.24	

NOTES:

1. Thread Class: #0 to 1" - 3A, over 1" - 2A
2. Working Temperature: -50°C to +300°C
3. Torques calculated in accordance with VDI 2230 "Systematic calculation of high duty bolted joints" with $\sigma 0.2 = 155 \text{ K.S.I.}$ and $\mu = 0.125$ for plain finish and $\mu = 0.094$ for plated. Above 0.625" dia. $\sigma 0.2 = 140 \text{ K.S.I.}$
4. The following diameters are fully interchangeable between 1936 and 1960 series:- No 10, 1/4", 3/8", 1/2" for both UNC and UNF

Head Marking



'X' represents Lot Traceability E-CODE

Unbrako

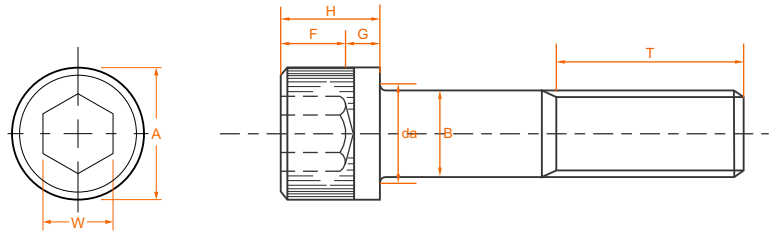

Product Dimensions

Thread Size nom.	Threads per Inch		Head Diameter A		Hex Socket Size W nom.	Head Height H		Key Depth F min.	Key Depth G min.
	UNRC	UNRF	max	min		max	min		
5/8	11	18	.938	.921	.500	.625	.616	.307	.238
3/4	10	16	1.125	1.107	.625	.750	.740	.370	.285
7/8	9	14	1.312	1.293	.750	.875	.864	.432	.333
1	8	12	1.500	1.479	.750	1.000	.988	.495	.380
1	-	14*	1.500	1.479	.750	1.000	.988	.495	.380
1 1/8	7	12	1.688	1.665	.875	1.125	1.111	.557	.428
1 1/4	7	12	1.875	1.852	.875	1.250	1.236	.620	.475
1 3/8	6	12	2.062	2.038	1.000	1.375	1.360	.682	.523
1 1/2	6	12	2.250	2.224	1.000	1.500	1.485	.745	.570
1 3/4	5	12	2.625	2.597	1.250	1.750	1.734	.870	.665
2	4 1/2	12	3.000	2.970	1.500	2.000	1.983	.995	.760
2 1/4	4 1/2	12	3.375	3.344	1.750	2.250	2.232	1.120	.855
2 1/2	4	12	3.750	3.717	1.750	2.500	2.481	1.245	.950
2 3/4	4	12	4.125	4.090	2.000	2.750	2.730	1.370	1.045
3	4	12	4.500	4.464	2.250	3.000	2.979	1.495	1.140

Thread Size nom.	Body Diameter B		Transition Diameter da		Thread Length T min	Recommended seating torque (in-lbs)	
	max	min	max	min		UNRC	UNRF
5/8	.625	.6163	.689	.562	1.750	3,400	3,820
3/4	.750	.7406	.828	.681	2.000	6,000	6,800
7/8	.875	.8647	.963	.798	2.250	8,400	9,120
1	1.000	.9886	1.100	.914	2.500	12,500	13,200
1	1.000	.9886	1.100	.914	2.500	-	13,900
1 1/8	1.125	1.1086	1.235	1.023	2.812	14,900	16,600
1 1/4	1.250	1.2336	1.370	1.148	3.125	25,000	27,000
1 3/8	1.375	1.3568	1.505	1.256	3.437	33,000	35,000
1 1/2	1.500	1.4818	1.640	1.381	3.750	43,500	47,000
1 3/4	1.750	1.7295	1.910	1.609	4.375	71,500	82,500
2	2.000	1.9780	2.180	1.843	5.000	108,000	125,000
2 1/4	2.250	2.2280	2.450	2.093	5.625	155,000	186,000
2 1/2	2.500	2.4762	2.720	2.324	6.250	215,000	248,000
2 3/4	2.750	2.7262	2.990	2.574	6.875	290,000	330,000
3	3.000	2.9762	3.260	2.824	7.500	375,000	430,000

Socket Head Cap Screws - 1960 series

Body and Grip Lengths

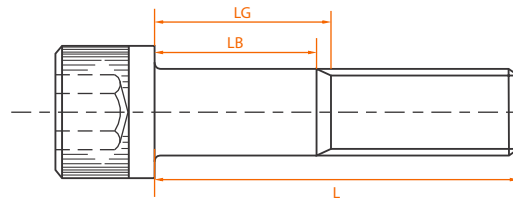

HIGH-GRADE ALLOY STEEL

Length L Nom.	#0		#1		#2		#3		#4		#5		#6		#8		#10		#1/4	
	L _G	L _B	L _G	L _B	L _G	L _B	L _G	L _B	L _G	L _B	L _G	L _B	L _G	L _B	L _G	L _B	L _G	L _B	L _G	L _B
3/4	.250	.187																		
7/8	.250	.187	.250	.172	.250	.161	.250	.146												
1	.500	.437	.250	.172	.250	.161	.250	.146	.250	.125	.250	.125								
1 1/4	.750	.687	.625	.547	.625	.536	.625	.521	.250	.125	.250	.125	.500	.344	.375	.219	.375	.167		
1 1/2			.875	.797	.875	.786	.875	.771	.750	.625	.750	.625	.500	.344	.375	.219	.375	.167	.500	.250
1 3/4					1.125	1.036	1.125	1.021	.750	.625	.750	.625	1.000	.844	.875	.719	.875	.667	.500	.250
2							1.375	1.271	1.250	1.125	1.250	1.125	1.000	.844	.875	.719	.875	.667	1.000	.750
2 1/4									1.250	1.125	1.250	1.125	1.500	1.344	1.375	1.219	1.375	1.167	1.000	.750
2 1/2											1.750	1.625	1.500	1.344	1.375	1.219	1.375	1.167	1.500	1.250
2 3/4													2.000	1.844	1.875	1.719	1.875	1.667	1.500	1.250
3															1.875	1.719	1.875	1.667	2.000	1.750
3 1/4															2.375	2.219	2.375	2.167	2.000	1.750
3 1/2																	2.375	2.167	2.500	2.250
3 3/4																	2.875	2.667	2.500	2.250
4																	2.875	2.667	3.000	2.750
4 1/4																			3.000	2.750
4 1/2																			3.500	3.250
4 3/4																			3.500	3.250
5																			4.000	3.750
5 1/4																				
5 1/2																				
5 3/4																				
6																				
6 1/4																				
6 1/2																				
6 3/4																				
7																				
7 1/4																				
7 1/2																				
7 3/4																				
8																				
8 1/2																				
9																				
9 1/2																				
10																				
11																				
12																				
13																				
14																				
15																				
16																				
17																				
18																				
19																				
20																				

Length Tolerance				
Diameter	up to 1" incl.	over 1" to 2 1/2" incl.	over 2 1/2" to 6" incl.	over 6"
#0 thru 3/8 incl.	-.03	-.04	-.06	-.12
7/16 to 3/4 incl.	-.03	-.06	-.08	-.12
7/8 to 1-1/2 incl.	-.05	-.10	-.14	-.20
over 1 1/2		-.18	-.20	-.24

LG is the maximum grip length and is the distance from the bearing surface to the first complete thread. LB is the minimum body length and is the length of the unthreaded cylindrical portion of the shank. Thread length for the sizes up to and including 1" diameter shall be controlled by the grip length and body length as shown in the table. For sizes larger than 1" the minimum complete thread length shall be equal to the basic thread length, and the total thread length including imperfect threads shall be basic thread length plus five pitches. Lengths too short to apply formula shall be threaded to head. Complete threads shall extend within two pitches of the head lengths above the heavy line on sizes up to and including 5/8" dia. Larger diameters shall be threaded as close to the head as practicable. Screws of longer lengths than those tabulated shall have a thread length conforming to the formula for sizes larger than 1".

Socket Head Cap Screws - 1960 series

Body and Grip Lengths

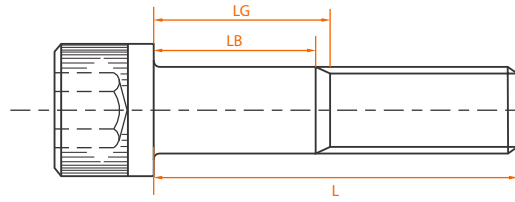

Length L Nom.	5/16		3/8		7/16		1/2		5/8		3/4		7/8		1	
	L _G	L _B	L _G	L _B	L _G	L _B	L _G	L _B	L _G	L _B	L _G	L _B	L _G	L _B	L _G	L _B
3/4																
7/8																
1																
1 1/4																
1 1/2																
1 3/4	.625	.347	.500	.187												
2	.625	.347	.500	.187	.625	.268										
2 1/4	1.125	.847	1.000	.687	.625	.268	.750	.365								
2 1/2	1.125	.847	1.000	.687	1.125	.768	.750	.365	.750	.295						
2 3/4	1.625	1.187	1.500	1.187	1.125	.768	.750	.365	.750	.295	1.000	.500				
3	1.625	1.347	1.500	1.187	1.625	1.268	1.500	1.115	.750	.295	1.000	.500				
3 1/4	2.125	1.847	2.000	1.687	1.625	1.268	1.500	1.115	1.500	1.045	1.000	.500	1.000	.444		
3 1/2	2.125	1.847	2.000	1.687	2.125	1.768	1.500	1.115	1.500	1.045	1.000	.500	1.000	.444	1.000	.375
3 3/4	2.625	2.347	2.500	2.187	2.125	1.768	2.250	1.865	1.500	1.045	1.000	.500	1.000	.444	1.000	.375
4	2.625	2.347	2.500	2.187	2.625	2.268	2.250	1.865	2.250	1.795	2.000	1.500	1.000	.444	1.000	.375
4 1/4	3.125	2.847	3.000	2.687	2.625	2.268	2.250	1.865	2.250	1.795	2.000	1.500	2.000	1.444	1.000	.375
4 1/2	3.125	2.847	3.000	2.687	3.125	2.768	3.000	2.615	2.250	1.795	2.000	1.500	2.000	1.444	2.000	1.375
4 3/4	3.625	3.347	3.500	3.187	3.125	2.768	3.000	2.615	3.000	2.545	2.000	1.500	2.000	1.444	2.000	1.375
5	3.625	3.347	3.500	3.187	3.625	3.268	3.000	2.615	3.000	2.545	3.000	2.500	2.000	1.444	2.000	1.375
5 1/4	4.125	3.847	4.000	3.687	3.625	3.268	3.750	3.365	3.000	2.545	3.000	2.500	3.000	2.444	2.000	1.375
5 1/2	4.125	3.847	4.000	3.687	4.125	3.768	3.750	3.365	3.750	3.295	3.000	2.500	3.000	2.444	3.000	2.375
5 3/4	4.625	4.347	4.500	4.187	4.125	3.768	3.750	3.365	3.750	3.295	3.000	2.500	3.000	2.444	3.000	2.375
6	4.625	4.347	4.500	4.187	4.625	4.268	4.500	4.115	3.750	3.295	4.000	3.500	3.000	2.444	3.000	2.375
6 1/4	5.125	4.847	5.000	4.687	4.625	4.268	4.500	4.115	4.500	4.045	4.000	3.500	4.000	3.444	3.000	2.375
6 1/2			5.000	4.687	5.125	4.768	4.500	4.115	4.500	4.045	4.000	3.500	4.000	3.444	4.000	3.375
6 3/4			5.500	5.187	5.125	4.768	5.250	4.865	4.500	4.045	4.000	3.500	4.000	3.444	4.000	3.375
7			5.500	5.187	5.625	5.268	5.250	4.865	5.250	4.795	5.000	4.500	4.000	3.444	4.000	3.375
7 1/4			6.000	5.687	5.625	5.268	5.250	4.865	5.250	4.795	5.000	4.500	5.000	4.444	4.000	4.375
7 1/2			6.000	5.687	6.125	5.768	6.000	5.615	5.250	4.795	5.000	4.500	5.000	4.444	5.000	4.375
7 3/4					6.125	5.768	6.000	5.615	6.000	5.545	5.000	4.500	5.000	4.444	5.000	4.375
8					6.625	6.268	6.000	5.615	6.000	5.545	6.000	5.500	5.000	4.444	5.000	4.375
8 1/2					7.125	6.768	7.000	6.615	6.750	6.295	6.000	5.500	6.000	5.444	6.000	5.375
9					7.625	7.268	7.000	6.615	6.750	6.295	7.000	6.500	6.000	5.444	6.000	5.375
9 1/2							8.000	7.615	7.750	7.295	7.000	6.500	7.000	6.444	7.000	6.375
10							8.000	7.615	7.750	7.295	8.000	7.500	7.000	6.444	7.000	6.375
11									9.250	8.795	9.000	8.500	8.000	7.444	8.000	7.375
12									10.250	9.795	10.000	9.000	9.000	8.444	9.000	8.375
13											11.000	10.500	10.000	9.444	10.000	9.375
14											12.000	11.500	11.000	10.444	11.000	10.375
15											13.000	12.500	12.000	11.444	12.000	11.375
16													13.000	12.444	13.000	12.375
17													14.000	13.444	14.000	13.375
18													15.000	14.444	15.000	14.375
19															16.000	15.375
20															17.000	16.375

Socket Head Cap Screws - 1960 Series



HIGH-GRADE ALLOY STEEL

Size	Part No.		lbs. /1000
#0-80 UNF - Key Size 0.05"			
#0 x 3/16	117137	100	0.17
1/4	117153	100	0.18
3/8	121059	100	0.22
#1-72 UNF - Key Size 1/16"			
#1 x 1/4	117202	100	0.36
3/8	102704	100	0.45
#2-56 UNC - Key Size 5/64"			
#2 x 3/16	105493	100	0.47
1/4	105509	100	0.58
3/8	113307	100	0.75
1/2	113323	100	0.93
5/8	700572	100	1.05
3/4	700573	100	1.18
1	700574	100	1.44
#3-48 UNC - Key Size 5/64"			
#3 x 1/4	113374	100	0.80
3/8	107750	100	0.98
1/2	107766	100	1.22
5/8	700581	100	1.47
3/4	700582	100	1.71
#4-40 UNC - Key Size 3/32"			
#4 x 1/4	107783	100	1.21
3/8	107799	100	1.50
1/2	107816	100	1.72
5/8	107832	100	1.96
3/4	107849	100	2.27
1	109394	100	2.88
1 1/4	120922	100	3.43
1 1/2	109070	100	4.20
#5-40 UNC - Key Size 3/32"			
#5 x 1/4	107865	100	1.61
5/16	112658	100	1.76
3/8	107881	100	1.94
1/2	107897	100	2.27
5/8	113390	100	2.60
3/4	113407	100	2.97
1	112049	100	3.83
#6-32 UNC - Key Size 7/64"			
#6 x 1/4	113423	100	1.98
5/16	109328	100	2.29

Size	Part No.		lbs. /1000
#6-32 UNC - Key Size 7/64"			
#6 x 3/8	113440	100	2.42
1/2	118792	100	2.86
5/8	118808	100	3.30
3/4	118824	100	3.61
7/8	118840	100	4.00
1	118856	100	4.38
1 1/4	112179	100	5.68
1 1/2	114328	100	6.45
#6-40 UNF - Key Size 7/64"			
#6 x 1/4	102720	100	2.09
3/8	111564	100	2.53
1/2	111581	100	2.79
5/8	111597	100	3.19
3/4	114012	100	3.56
1	700842	100	4.22
#8-32 UNC - Key Size 9/64"			
#8 x 1/4	118872	100	3.08
5/16	117320	100	3.63
3/8	118888	100	3.96
1/2	118904	100	4.53
5/8	118920	100	4.84
3/4	118936	100	5.50
7/8	103140	100	6.20
1	103156	100	6.69
1 1/4	103174	100	8.12
1 1/2	103190	100	9.66
1 3/4	117451	100	11.18
2	117516	100	12.39
2 1/4	120791	100	15.29
#8-36 UNF - Key Size 9/64"			
#8 x 3/8	700845	100	3.51
1/2	117699	100	4.40
5/8	700847	100	4.78
3/4	117715	100	5.54
1	700849	100	6.16
#10-24 UNC - Key Size 5/32"			
#10 x 1/4	109734	100	4.80
3/8	103206	100	5.50
1/2	112492	100	6.25
5/8	112508	100	7.00
3/4	112524	100	7.70
7/8	112540	100	8.45
1	112557	100	9.20
1 1/4	103215	100	11.13
1 1/2	103232	100	13.07

Size	Part No.		lbs. /1000
#10-24 UNC - Key Size 5/32"			
#10 x 1 3/4	103248	100	14.96
2	103264	100	16.94
2 1/4	108823	100	19.12
2 1/2	106226	100	20.83
2 3/4	103477	100	23.01
3	106355	100	24.46
3 1/2	116278	100	28.38
4	116279	100	32.34
#10-32 UNF - Key Size 5/32"			
#10 x 1/4	111756	100	4.80
5/16	116280	100	5.30
3/8	117733	100	5.50
1/2	117749	100	6.25
5/8	117765	100	7.00
3/4	117781	100	7.70
7/8	117798	100	8.45
1	117814	100	9.20
1 1/4	117830	100	11.79
1 1/2	117847	100	13.07
1 3/4	117863	100	14.96
2	117879	100	16.94
2 1/4	107085	100	19.54
2 1/2	107150	100	21.12
3	107182	100	25.01
1/4-20 UNC - Key Size 3/16"			
1/4 x 1/4	120048	100	9.00
3/8	105232	100	10.30
1/2	105248	100	11.59
5/8	108937	100	12.89
3/4	108954	100	14.19
7/8	108969	100	15.49
1	105256	100	16.72
1 1/4	105272	100	19.36
1 3/8	117409	100	20.72
1 1/2	105288	100	22.77
1 3/4	105304	100	26.16
2	105320	100	29.48
2 1/4	105336	100	32.91
2 1/2	118338	100	36.30
2 3/4	118355	100	39.67
3	118371	100	43.05
3 1/4	117539	100	46.46
3 1/2	117573	100	49.81
3 3/4	117605	100	53.20
4	109434	100	57.35
4 1/2	109499	100	64.11
5	114978	100	70.86

Socket Head Cap Screws - 1960 Series

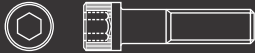

Size	Part No.		lbs. /1000
1/4-20 UNC - Key Size 3/16"			
1/4 x 5 1/2	105637	100	77.64
6	115042	100	84.39
1/4-28 UNF - Key Size 3/16"			
1/4 x 1/4	114545	100	9.00
3/8	117896	100	10.30
1/2	117913	100	11.59
5/8	111454	100	12.89
3/4	111471	100	14.19
7/8	111487	100	15.49
1	111503	100	16.72
1 1/4	111519	100	19.36
1 1/2	111535	100	22.77
1 3/4	108026	100	26.16
2	108042	100	29.48
2 1/4	108057	100	32.91
2 1/2	118427	100	36.30
2 3/4	118460	100	40.70
3	118476	100	43.05
3 1/2	116281	100	51.44
4	116283	100	58.19
5/16-18 UNC - Key Size 1/4"			
5/16 x 3/8	118387	100	18.79
1/2	118403	100	20.68
5/8	118419	100	22.88
3/4	118436	100	25.30
7/8	104055	100	27.24
1	104071	100	29.70
1 1/4	104088	100	33.99
1 1/2	104104	100	38.50
1 3/4	104121	100	45.01
2	104137	100	48.84
2 1/4	104153	100	55.86
2 1/2	109900	100	59.62
2 3/4	109916	100	66.73
3	109932	100	70.40
3 1/4	109950	50	74.71
3 1/2	109966	50	81.80
4	109833	100	92.64
4 1/2	109866	100	100.85
5	103652	100	110.68
5 1/2	121215	100	125.20
6	103684	100	136.07
5/16-24 UNF - Key Size 5/32"			
5/16 x 1/2	108073	100	20.90
5/8	104516	100	22.04
3/4	104532	100	24.29

Size	Part No.		lbs. /1000
5/16-24 UNF - Key Size 1/4"			
5/16 x 7/8	104548	100	26.53
1	110752	100	30.51
1 1/4	110769	100	35.00
1 1/2	110786	100	39.53
1 3/4	110802	100	46.33
2	110818	100	50.84
2 1/4	110834	100	57.16
2 1/2	110850	100	61.67
2 3/4	105606	100	65.45
3	105344	100	70.95
3 1/2	106016	100	83.40
4	120995	100	94.23
3/8-16 UNC - Key Size 5/16"			
3/8 x 1/2	109982	100	33.22
5/8	109999	100	36.30
3/4	110015	100	39.38
7/8	110031	100	42.46
1	110048	100	45.54
1 1/8	103784	100	48.33
1 1/4	110065	100	51.68
1 3/8	103816	100	54.76
1 1/2	115710	100	57.84
1 3/4	115727	50	65.49
2	115743	50	73.04
2 1/4	115760	50	80.81
2 1/2	115776	50	88.44
2 3/4	115792	50	95.92
3	115808	50	103.75
3 1/4	115824	50	111.32
3 1/2	122480	50	119.06
3 3/4	105003	50	128.22
4	115857	50	134.42
4 1/2	115873	50	149.69
5	115889	50	165.00
5 1/2	105035	50	180.29
5 3/4	113866	50	189.46
6	112859	50	195.60
6 1/2	111241	50	210.91
8	112990	25	256.85
3/8-24 UNF - Key Size 3/16"			
3/8 x 1/2	110867	100	33.22
5/8	110883	100	36.30
3/4	110900	100	39.38
7/8	110917	100	42.46
1	110934	100	47.52
1 1/4	110950	100	51.68
1 1/2	110966	100	57.84

Size	Part No.		lbs. /1000
3/8-24 UNF - Key Size 5/16"			
3/8 x 1 3/4	116440	50	65.49
2	116456	50	73.04
2 1/4	116472	50	80.81
2 1/2	116488	50	88.44
2 3/4	112246	50	100.10
3	116504	50	106.74
3 1/4	400467	50	111.41
3 1/2	112278	50	119.06
4	119090	50	137.37
4 1/2	108318	50	152.68
7/16-14 UNC - Key Size 3/8"			
7/16 x 3/4	107385	100	58.19
7/8	107417	100	61.01
1	107449	100	66.59
1 1/4	118520	50	75.02
1 1/2	118554	50	81.84
1 3/4	118586	50	91.89
2	118619	50	105.34
2 1/4	116299	50	113.78
2 1/2	116332	50	126.21
2 3/4	116364	25	134.66
3	116396	25	147.09
3 1/2	110568	25	167.97
4	115611	25	188.85
4 1/2	104743	25	209.73
5	110554	25	230.58
7/16-20 UNF - Key Size 3/8"			
7/16 x 1	116520	100	69.15
1 1/4	104561	50	78.23
1 1/2	104577	50	87.32
2	104593	50	108.86
2 1/2	105615	50	130.39
3	122789	25	150.61
3 1/2	116284	25	171.47
1/2-13 UNC - Key Size 3/8"			
1/2 x 1/2	115644	50	74.36
5/8	115677	50	79.95
3/4	102603	50	85.51
7/8	102636	50	91.08
1	102670	50	96.69
1 1/4	102703	50	107.80
1 1/2	107950	50	118.80
1 3/4	108016	50	130.17
2	102464	50	141.24
2 1/4	110772	25	154.88
2 1/2	110837	25	168.63

Socket Head Cap Screws - 1960 Series



HIGH-GRADE ALLOY STEEL

Size	Part No.		lbs. /1000
1/2-13 UNC - Key Size 3/8"			
1/2 x 2 3/4	110903	25	182.16
3	120761	25	195.91
3 1/4	111303	25	212.08
3 1/2	111575	25	223.23
3 3/4	103111	25	241.87
4	111608	25	257.51
4 1/4	107772	25	264.18
4 1/2	111641	25	287.98
4 3/4	119162	25	293.99
5	111673	25	305.76
5 1/4	107805	25	316.29
5 1/2	115511	25	340.78
5 3/4	107839	25	346.08
6	115544	25	371.36
6 1/4	105005	10	375.98
6 1/2	115576	10	393.73
7	109736	10	416.83
7 1/2	107937	10	446.62
8	109768	10	468.95
8 1/2	108003	10	501.16
9	102417	10	523.60
10	102451	10	578.16
11	108275	10	637.78
12	105569	10	692.34
1/2-20 UNF - Key Size 3/8"			
1/2 x 3/4	116247	50	88.11
1	104609	50	100.12
1 1/4	104625	50	107.80
1 1/2	109763	50	118.80
1 3/4	109780	50	130.17
2	109796	50	141.24
2 1/4	122870	25	154.88
2 1/2	107220	25	168.63
2 3/4	111047	25	182.16
3	107237	25	195.91
3 1/2	116617	25	223.21
4	119272	25	257.51
4 1/2	700928	25	287.98
5	116285	25	317.31
5 1/2	700930	25	346.92
6	116286	25	364.76
7	700932	25	430.28
8	700933	25	484.00
5/8-11 UNC - Key Size 1/2"			
5/8 x 1	109802	25	170.32
1 1/4	109593	25	188.08
1 1/2	109626	25	205.81

Size	Part No.		lbs. /1000
5/8-11 UNC - Key Size 1/2"			
5/8 x 1 3/4	116335	25	225.39
2	111036	25	241.30
2 1/4	111069	25	255.82
2 1/2	111101	25	287.76
2 3/4	116639	25	305.49
3	116673	25	323.09
3 1/4	116705	25	351.74
3 1/2	116737	25	369.69
4	102196	25	408.58
4 1/2	102047	25	451.64
5	120714	25	498.10
5 1/2	120746	10	544.50
6	120778	10	580.14
6 1/2	111320	10	626.56
7	111354	10	672.98
7 1/2	122898	10	708.47
8	104175	10	755.04
8 1/2	109197	10	801.46
9	118276	5	836.88
10	106599	5	922.46
11	107003	5	1015.52
12	115134	5	1110.12
5/8-18 UNF - Key Size 1/2"			
5/8 x 1	117868	25	170.32
1 1/4	117884	25	188.10
1 1/2	117901	25	205.81
1 3/4	117918	25	223.52
2	117935	25	241.34
2 1/4	105032	25	258.94
2 1/2	117951	25	287.76
3	105894	25	323.18
3 1/2	121385	25	369.60
4	117038	25	416.24
4 1/2	700946	25	462.00
5	119030	25	498.08
5 1/2	700948	10	544.50
6	107467	25	580.14
3/4-10 UNC - Key Size 5/8"			
3/4 x 1 1/4	104210	25	298.54
1 1/2	104244	25	324.96
1 3/4	113859	25	350.46
2	113892	25	376.64
2 1/4	113924	25	402.16
2 1/2	113957	25	428.34
2 3/4	113990	25	453.93
3	111623	25	499.64
3 1/4	111656	25	525.54

Size	Part No.		lbs. /1000
3/4-10 UNC - Key Size 5/8"			
3/4 x 3 1/2	111689	25	550.00
3 3/4	111246	25	577.30
4	111722	25	623.02
4 1/2	104539	25	674.78
5	110759	25	746.46
5 1/2	110793	10	798.16
6	121562	10	869.66
6 1/2	110858	10	921.58
7	110891	10	993.08
8	110924	10	1116.28
8 1/2	103863	10	1168.20
9	107374	10	1239.92
9 1/2	107438	10	1291.62
10	118545	10	1363.12
11	121572	10	1486.54
12	118610	10	1609.96
13	108283	10	1733.38
3/4-16 UNF - Key Size 5/8"			
3/4 x 1 1/4	700952	25	298.54
1 1/2	120615	25	324.50
2	120376	25	376.29
2 1/2	138871	25	428.12
3	102344	25	499.64
3 1/2	117976	25	551.41
4	118041	25	623.04
4 1/2	114043	25	674.78
5	116293	25	746.46
6	700962	10	869.66
7/8-9 UNC - Key Size 3/4"			
7/8 x 2	110957	10	559.37
2 1/4	116447	10	594.88
2 1/2	116479	10	630.52
2 3/4	116511	10	665.94
3	104568	10	701.36
3 1/4	104600	10	765.16
3 1/2	104632	10	800.58
4	104665	10	899.80
4 1/2	104697	10	968.00
5	104729	10	1041.79
5 1/2	104761	10	1140.92
6	104793	10	1210.00
6 1/2	110251	10	1311.20
7	115937	10	1382.26
8	115970	10	1552.32

Socket Head Cap Screws - 1960 Series

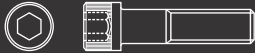

Size	Part No.		lbs. /1000
7/8-14 UNF - Key Size 3/4"			
7/8 X 2 1/2	106327	10	563.20
3 1/2	105086	10	800.58
1-8 UNC - Key Size 3/4"			
1 X 1 1/2	102584	10	698.72
2	116002	10	809.29
2 1/4	116035	10	836.00
2 1/2	115091	10	887.04
2 3/4	115123	10	932.80
3	104702	10	887.13
3 1/4	115189	10	1026.34
3 1/2	114821	10	1113.66
4	114853	10	1160.52
4 1/2	114888	10	1301.39
5	114920	10	1424.08
5 1/2	103572	10	1520.82
6	103589	10	1646.35
6 1/2	103606	10	1775.18
7	103623	10	1868.68
7 1/2	100398	10	1997.27
8	122961	10	2090.88
8 1/2	105063	10	2219.58
9	116867	10	2313.08
9 1/2	121557	10	2441.78
10	116899	10	2535.50
11	102035	5	2757.70
12	104168	5	2979.90
14	121558	5	3424.52
1-12 UNF Key Size 3/4"			
1 X 2 3/4	117604	10	964.06
3 1/2	109908	10	1108.21
5 1/2	105362	10	1520.20
6	116289	10	1646.26
8	105350	10	2090.88
1 1/4-7 UNC - Key Size 7/8"			
1 1/4 X 2 1/2	115451	1	1596.98
3	115468	1	1745.57
3 1/2	121587	1	1893.98
4	104842	1	2086.48
4 1/2	104857	1	2136.29
5	112918	1	2433.86
5 1/2	104887	1	2596.00
6	110103	1	2781.13
6 1/2	110118	1	2954.82
7	110136	1	3124.00
8	110152	1	3475.78
9	110168	1	3822.94

Size	Part No.		lbs. /1000
1 1/4-7 UNC - Key Size 7/8"			
1 1/4 X 10	110184	1	4170.32
12	110201	1	4864.86
1 1/4-12 UNF - Key Size 7/8"			
1 1/4 X 3 1/2	106603	1	1912.90
4	116291	1	2086.48
4 1/2	108258	1	2260.06
5	109017	1	2433.86
5 1/2	116292	1	2607.44
6	107644	1	2781.24
1 1/2-6 UNC - Key Size 1"			
1 1/2 X 3	110217	1	2772.66
3 1/2	110234	1	2984.30
4	110250	1	3195.94
4 1/2	115919	1	3407.58
5	115936	1	3715.36
5 1/2	115953	1	3965.39
6	115969	1	4215.42
6 1/2	115985	1	4465.34
7	116001	1	4323.00
8	116017	1	4816.02
9	116033	1	5715.60
10	116050	1	6215.88
12	116068	1	7215.78
1 1/2-12 UNF Key Size 1"			
1 1/2 X 3	103034	1	2772.66
3 1/2	116143	1	2984.30
4	110258	1	3195.94
4 1/2	110290	1	3407.58
5	110697	1	3715.36
5 1/2	109136	1	3965.28
6	106106	1	4215.42
8	100447	1	4816.02
10	114786	1	6215.88

Note:
 • Sizes above the bold line are threaded to head.
 • The following diameters are fully interchangeable between 1936 and 1960 series:-
 No 10, 1/4", 3/8", 1/2" both UNC and UNF

**HIGH-PERFORMANCE
STAINLESS STEEL
FASTENERS**

**Unbrako Stainless Steel
304/316**

**Range in
A2-70, A2-80, A4-70
A4-80, A4-90 & A4-100**



Special Orders Only

- Socket Head Cap Screws
- Socket Countersunk Head Screws
- Socket Button Head Screws
- Hex Head Screws
- Hex Nuts
- Plain Washer
- Spring Washer
- Socket Set Screws
- Threaded Rod
- Specials

SOCKET LOW HEAD CAP SCREWS

Unbrako
THE WORLD LEADER

Low Head Socket Cap Screws are High Strength, precision fasteners designed for applications where head height clearance is a problem.

Low Head Socket Head Cap Screws cannot be pre-loaded as high as a standard socket head cap screw because of their reduced head height and smaller socket size.

Low Head Socket Head Cap Screws are manufactured from High Strength Alloy Steel and have a Black Oxide finish.

Low head height for thin parts and limited space.

Fillet under head increases fatigue life of head-to-shank junction.

Class 3A rolled threads with radiused root to increase fatigue life of threads by reducing stress concentrations and avoiding sharp corners where failures start.

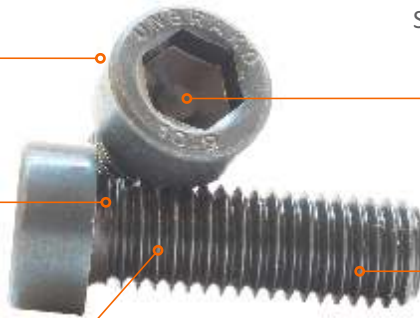

Smooth, burr-free sockets, uniformly concentric and usable to full depth for correct wrench engagement.

Highest standards of quality, material, manufacture and performance.



Hardness : 40 - 43 HRC
33 - 39 HRC

Tensile Strength : 1040 N/mm²
Yield Strength : 940 N/mm²

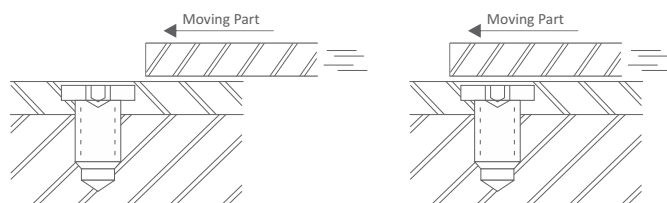

High Strength Fasteners for applications with limited clearance.



Suitable for use in parts too thin for standard Socket Head Cap Screw and for applications with limited clearance.

Equivalent Standards

DIN 7984 + 6912
(Except for Head & Socket Dims)

Mechanical Properties

Material: Unbrako High Grade Alloy Steel
 Property Class: 10.9
 Heat Treatment: Rc 33-39
 Tensile Strength: 1040 N/mm²
 Yield Strength: 940 N/mm²
 Shear Strength: 624 N/mm²
 Min. Elongation: 9%

NOTES:

1. Body and Grip Lengths are same as metric Socket Head Cap Screws. (see page no.16)
2. Thread Class: 6g
3. Working Temperature: -50°C to +300°C
4. Sizes M5 and larger are stamped U 10.9. Torques calculated in accordance with VDI 2230 "Systematic calculation of high duty bolted joints" with $\sigma 0.2 = 900 \text{ N/mm}^2$ and $\mu = 0.125$ for plain finish and $\mu = 0.094$ for plated.

Length 'L' Tolerance (mm)

Screws Over	Up to and including	Tolerance
-	50	±0.25
50	80	±0.50
80	120	±0.70
120	250	±0.80
250	-	±1.00

Head Marking



Head markings may vary slightly depending on manufacturing practice. UNBRAKO and UNB are recognized identifications for M5 diameter & larger.

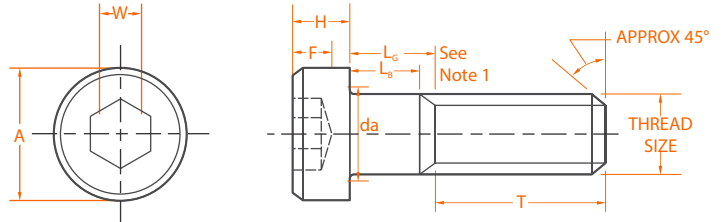

Product Dimensions

Thread size nom.	Pitch	Head Diameter A max	Hex Socket Size W nom.	Head Height H max	Key Depth F min.	Transition Diameter da max.	Thread Length T ref
M4	0.70	7	3	2.8	1.48	4.7	20
M5	0.80	8.5	4	3.5	1.85	5.7	22
M6	1.00	10	5	4.0	2.09	6.8	24
M8	1.25	13	6	5.0	2.48	9.2	28
M10	1.50	16	8	6.5	3.36	11.2	32
M12	1.75	18	10	8.0	4.26	13.7	36
M16	2.00	24	12	10.0	4.76	17.7	44
M20	2.50	30	14	12.5	6.07	22.4	52

Thread size nom.	Recommended Seating Torque				Induced Load	
	Unplated		Plated		kN	lbf.
	N-m	lbf.in.	N-m	lbf.in.		
M4	3.8	33.6	2.9	25.7	5.65	1,270
M5	8.0	70.8	6.0	53.1	9.20	2,068
M6	13.0	115.0	9.8	86.7	13.00	2,920
M8	32.0	283.0	24.0	212.0	23.90	5,370
M10	64.0	566.0	48.0	425.0	38.00	8,540
M12	110.0	974.0	83.0	735.0	55.50	12,470
M16	275.0	2,434.0	206.0	1,820.0	105.00	23,600
M20	550.0	4,870.0	405.0	3,585.0	164.00	36,800

as per Unbrako standard



Suitable for use in parts too thin for standard Socket Head Cap Screw and for applications with limited clearance.

Equivalent Standards

ASME B18.3

Mechanical Properties

Hardness	RC 38-43
Tensile Stress	170,000 psi min.
Yield Strength	150,000 psi min.

Length 'L' Tolerance (in)

Screw Over	upto & incl	Tolerance
-	1	-.030
1	2 1/2	-.040
2 1/2	-	-.060

Tensile and Shear Strength

Thread size nom.	Tensile Strength - lbs. min.		Shear strength in threads (calculated lbs.)	
	UNRC	UNRF	UNRC	UNRF
#8	2,380	2,500	1,450	1,570
#10	2,980	3,400	1,700	2,140
1/4	5,410	6,180	3,090	3,900
5/16	8,910	9,870	4,930	6,210
3/8	13,200	14,900	7,450	9,400
1/2	24,100	27,200	13,600	17,100

NOTES:

1. Body and Grip lengths are same as UNC/UNF Socket Head Cap Screws. (see pageno. 24)
2. Thread Class: 3A UNRC and UNRF

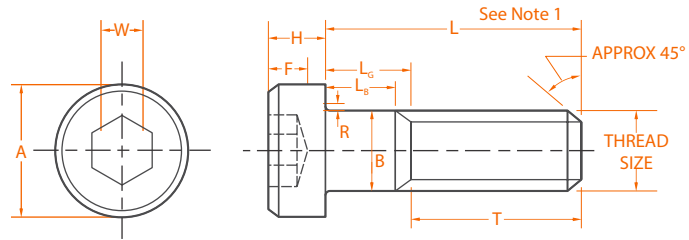

Product Dimensions

Thread size nom.	Thread per Inch		Body Diameter B max	Head Diameter A		Hex Socket Size W nom.	Head Height H		Fillet Extension R	
	UNRC	UNRF		max	min		max	min	max	min
#8	32	36	0.1640	.270	.265	.0781	.085	.079	.012	.007
#10	24	32	0.1900	.312	.307	.0938	.098	.092	.014	.009
1/4	20	28	0.2500	.375	.369	.1250	.127	.121	.014	.009
5/16	18	24	0.3125	.437	.431	.1562	.158	.152	.017	.012
3/8	16	24	0.3750	.562	.556	.1875	.192	.182	.020	.015
1/2	13	20	0.5000	.750	.743	.2500	.254	.244	.026	.020

Thread size nom.	Socket Depth F min.	Thread Length T ref.	Recommended seating torque in-lbs.
#8	.060	.875	25
#10	.072	.875	35
1/4	.094	1.000	80
5/16	.110	1.125	157
3/8	.115	1.250	278
1/2	.151	1.500	667

Head Marking



Head markings may vary slightly depending on manufacturing practice. UNBRAKO and UNB are recognized identifications for 1/4" diameter & larger.

Low Head Cap Screws



10.9 Metric

Size	Part No.		lbs. /1000
M4 (0.7) - Key Size 3MM			
M4 x 8	106250	200	2.86
10	106251	200	3.30
12	106255	200	3.74
16	106256	200	4.40
20	106257	200	5.06
25	106260	200	6.16
30	406185	200	7.04
M5 (0.8) - Key Size 4MM			
M5 x 8	106262	200	4.84
10	103500	200	5.50
12	103501	200	6.38
15	400790	200	7.26
16	103502	200	7.48
20	103597	200	8.80
25	103503	200	10.56
30	103505	200	11.26
M6 (1) - Key Size 5MM			
M6 x 8	106263	200	6.60
10	103508	200	8.14
12	103509	200	8.89
15	400792	200	10.56
16	103511	200	10.41
20	103512	200	12.76
25	103515	200	15.18
30	103516	200	17.38
35	103517	200	19.80
40	103518	200	22.00
45	106264	200	24.42
M8 (1.25) - Key Size 6MM			
M8 x 12	103519	200	18.04
15	400791	200	20.46
16	103520	200	21.34
20	103521	200	24.64
25	103525	200	28.82
30	103526	200	33.00
35	103528	200	36.96
40	103529	200	41.14
M10 (1.5) - Key Size 8MM			
M10 x 16	103532	200	35.86
20	103533	200	40.19
25	103534	200	45.65
30	103535	200	54.12

10.9 Metric

Size	Part No.		lbs. /1000
M10 (1.5) - Key Size 8MM			
M10 x 35	103536	200	56.52
40	103538	100	61.95
45	106271	100	73.70
50	103541	100	80.08
55	106272	100	86.68
M12 (1.75) - Key Size 10MM			
M12 x 20	103549	100	50.60
25	103550	100	56.10
30	103551	100	74.80
35	103552	100	84.48
40	103553	50	90.57
50	103554	50	113.08
60	103555	50	132.22
M16 (2) - Key Size 12MM			
M16 x 30	103562	25	149.60
35	103563	25	166.32
40	103564	25	183.04
45	106277	25	199.76
50	103565	25	216.48
60	103566	25	249.92
90	103574	25	356.40
100	103575	25	383.68
M20 (2.5) - Key Size 14MM			
M20 x 40	103578	25	301.4
50	103580	25	354.2
60	103581	25	407.0
100	103599	25	631.4

Sizes above the bold line are threaded to head.

Inch

Size	Part No.		lbs. /1000
#8-32 UNC - Key Size 5/64"			
#8 x 3/8	100598	100	2.95
1/2	100619	100	3.52
5/8	100671	100	4.05
3/4	100573	100	4.62
#10-24 UNC - Key Size 3/32"			
#10 x 3/8	100556	100	4.18
1/2	100579	100	4.75
5/8	100505	100	5.48
3/4	100717	100	6.18
1	100623	100	8.36
#10-32 UNF - Key Size 3/32"			
#10 x 3/8	100575	100	4.40
1/2	100541	100	5.06
5/8	100542	100	5.79
3/4	100718	100	6.82
1/4-20 UNC - Key Size 1/8"			
1/4 x 3/8	100506	100	7.70
1/2	100607	100	9.02
5/8	100507	100	9.94
3/4	100508	100	11.66
1	100719	100	14.08
5/16-18 UNC - Key Size 5/32"			
5/16 x 1/2	100720	100	14.74
3/4	100543	100	18.92
1	100620	100	23.10
1 1/4	100686	100	26.60
1 1/2	100544	100	31.68
3/8-16 UNC - Key Size 3/16"			
3/8 x 1/2	100608	100	25.08
3/4	100609	100	30.58
1	100509	100	36.70
1 1/4	100613	100	43.56
1 1/2	100565	100	48.93

All inch sizes are threaded to head.



SOCKET HEAD SHOULDER SCREWS

Unbrako shoulder screws are hardened shafts with a knurled head and threaded portion. The shoulder formed where the threads meet the larger diameter body acts as a stop when the screw is threaded into a tapped hole, permitting the screw to be used as a pivot, shaft, or stationary guide.

Unbrako shoulder screws are used to operate stripper plates and in pressure pads a wide variety of tool and die work. They are also used as shafts or pivots, holding pulleys, gears, cams and cam followers, ratchets and circular form tools. Stationary guide applications including locating pins in fixtures, latch stops, alignment of stationary members, linkage blocks, and stock guides in dies. Unbrako shoulder screws are especially advantageous in applications where the fastened part must be removed frequently. For instance, when the shoulder screw is used as a shaft for circular form tools, the screw can be removed to permit sharpening of the tool in a matter of seconds. Assembly is equally as fast.

Unbrako shoulder screws are made of high grade alloy steel the precision tolerance on the shoulder provides close and accurate mating with the fastened components. Unbrako manufactures to a tolerance position closer than that required by international standards.

FEATURES

Precision hex socket for maximum wrenching strength permits full tightening without cracking or reaming socket, yet provides ample metal in the crucial fillet area for maximum head strength.

Neck allows assembly with no chamfering or other hole preparation.

Knurled head for sure finger grip and fast assembly

Controlled concentricity between head and body for easier, more accurate assembly

Controlled root radius doubles fatigue life of threads by reducing stress concentrations and avoiding sharp corners where failures may start. Contour following flow lines of rolled threads provide extra strength, prevent stripping.

Finished threads close to body for maximum holding power

Shoulder diameter held to close tolerance



Applications

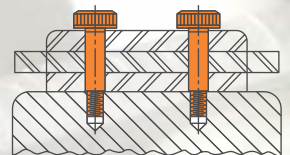

Stationary Guide

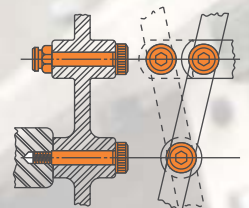

Moving Shaft or Pivot

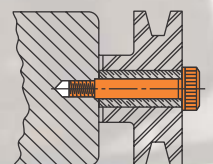

Pulley Shaft Uses



Replaces costly special parts – shafts, pivots, pins, guides, linkages and trunnion mountings. Also standard for tool and die industries.

Equivalent Standard

Specification: Generally conforming to ISO 7379, ASME B18.3.3M, BS 4168-7

Mechanical Properties

Material: Unbrako High Grade Alloy Steel
 Thread Class: 4g6g
 Hardness: Rc 39-43
 Shear Strength: 730 N/mm²
 Working Temperatures: -50°C to 300°C

Note

Because of their configuration, these screws cannot be tensile tested.

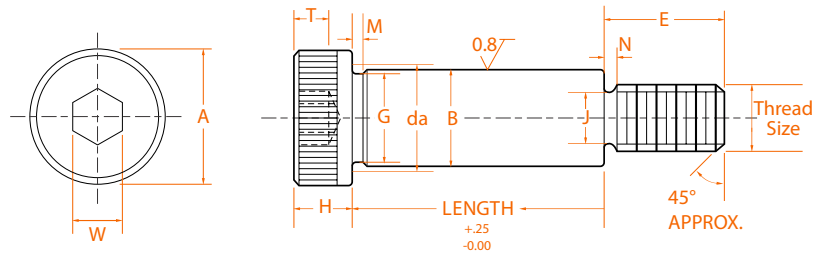

Product Dimensions

Body size nom.	Thread size	Pitch	Head Diameter	Hex Socket Size	Head Height	Socket Depth	Shoulder diameter		J max
			A max	W nom	H max	T min	max	min	
6	M5	0.80	10.00	3	4.50	2.4	6	5.96	3.84
8	M6	1.00	13.00	4	5.50	3.3	8	7.95	4.56
10	M8	1.25	16.00	5	7.00	4.2	10	9.95	6.23
12	M10	1.50	18.00	6	8.00	4.9	12	11.95	7.89
16	M12	1.75	24.00	8	10.00	6.6	16	15.95	9.54
20	M16	2.00	30.00	10	14.00	8.8	20	19.95	13.20
24	M20	2.50	36.00	12	16.00	10.0	24	23.95	16.54

Body size nom.	da max	N max	G max	M max	Thread Length	Recommended seating torque	
					E max	N-m	in-lbs.
6	6.80	2.00	5.62	1.85	9.75	7	60
8	9.20	2.50	7.62	1.85	11.25	12	105
10	11.20	3.00	9.62	1.85	13.25	29	255
12	14.20	3.50	11.62	1.85	16.40	57	500
16	18.20	4.00	15.62	1.85	18.40	100	885
20	22.40	4.50	19.62	2.50	22.40	240	2,125
24	26.40	5.60	23.62	2.65	27.40	470	4,160

CONCENTRICITY - Body to head O.D. within 0.002 TIR when checked in a 'V' block. Body to thread P.D. within 0.004 TIR when checked at a distance of 0.188 from the shoulder at the threaded end. Squareness, concentricity, parallelism and bow of body to thread P.D. shall be within 0.005 TIR per inch of body length with a maximum of 0.020 when seated against the shoulder in a threaded bush and checked on the body at a distance of 2M from the underside of the head.

Head Marking



Head markings may vary slightly depending on manufacturing practice. UNBRAKO and UNB are recognized identifications for M6 diameter & larger.



Socket Head Shoulder Screws - Metric



HIGH-GRADE ALLOY STEEL

Size	Part No.		lbs. /1000
------	----------	---	------------

6mm (M5-0.8) - Key Size 3mm

6 x 10	105364	50	12.43
12	105365	50	13.49
16	105366	50	15.58
20	105368	50	17.93
25	105370	50	20.28
30	105372	50	22.90
40	105373	50	28.14

8mm (M6-1) - Key Size 4mm

8 x 12	105375	50	26.00
16	105377	50	29.63
20	105379	50	33.29
25	105380	50	37.84
30	105381	50	42.39
40	105383	50	51.50
50	105386	50	60.59

10mm (M8-1.25) - Key Size 5mm

10 x 16	105388	50	51.04
20	105390	50	56.72
25	105392	50	63.82
30	105393	50	70.91
40	105394	50	85.07
50	105395	50	99.26
60	105396	50	113.30
70	105402	50	127.60
80	106422	50	141.79

12mm (M10-1.5) - Key Size 6mm

12 x 15	401485	25	78.56
16	105404	25	80.61
20	105406	25	88.70
25	105407	25	98.85
30	105410	25	109.01
40	105411	25	129.29
50	105412	25	149.58
60	105416	25	169.86
70	105417	25	190.15
80	105420	25	210.43
90	105427	25	230.74
100	105433	25	251.02

16mm (M12-1.75) - Key Size 8mm

16 x 30	105434	25	203.02
40	105435	25	238.70
50	105436	25	274.38
60	105437	25	310.05
70	105438	25	345.73

Size	Part No.		lbs. /1000
------	----------	---	------------

16mm (M12-1.75) - Key Size 8mm

16 x 80	105440	25	381.39
90	106343	25	417.08
100	106344	25	452.76
120	106346	25	524.11

20mm (M16-2) - Key Size 10mm

20 x 40	105441	10	423.61
50	105442	10	479.14
60	105444	10	534.64
70	105448	10	590.17
80	105449	10	645.68
90	105450	10	701.21
100	106347	10	756.71
120	106348	10	867.75

24mm (M20-2.5) - Key Size 12mm

24 x 50	401488	5	828.50
60	401489	5	906.49
70	401490	5	984.48
80	401491	5	1062.49
90	401492	5	1140.48
100	401493	5	1218.47
120	401494	5	1372.80

Note:

- Precision ground to h8 Tolerance on the shoulder.
- The Nominal Diameter of a shoulder screw is the diameter of the shoulder and not the thread diameter, but it is recommended that both are quoted when ordering Eg. 16mm x M12 x 70

ONE-OF-A-KIND FASTENER APP IN THE INDUSTRY.

INVALUABLE RESOURCE at Your Fingertips



FASTENER SELECTOR



Replaces costly special parts – shafts, pivots, pins, guides, linkages and trunnion mountings. Also standard for tool and die industries.

Equivalent Standard

ASME B18.3, BS 2470

Mechanical Properties

Hardness: Rockwell C 39-43;
 Shear Strength: 108,000 lbf/in²
 Working temperature: -50° to +300° C
 Thread class: 3A

Seating Torques and Strength

Thread size nom.	seating torque in-lbs.	ult. tensile strength lbs. (min)	single shear strength of body lbs. (min)
1/4	45	2,220	4,710
5/16	112	4,160	7,360
3/8	230	7,060	10,500
1/2	388	10,600	18,850
5/8	990	19,810	29,450
3/4	1,975	31,670	42,410
1	3,490	47,680	75,400
1-1/4	5,610	66,230	117,800
1-1/2	12,000	110,000	169,500
1-3/4	16,000	141,000	231,000
2	30,000	205,000	301,500

Note

Because of their configuration, these screws cannot be tensile tested.

Head Marking



Head markings may vary slightly depending on manufacturing practice. UNBRAKO and UNB are recognized identifications for 1/4" diameter & larger.

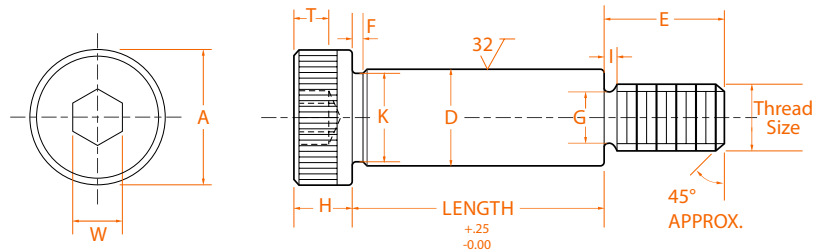

Product Dimensions

Body size nom.	Thread size	Threads per Inch UNRC	Head Diameter A max.	Hex Socket Size W nom	Head Height H max	Socket Depth T min.	Shoulder diameter D max. min.
1/4	#10	24	.375	.125	.188	.094	.248 .246
5/16	1/4	20	.438	.156	.219	.117	.311 .309
3/8	5/16	18	.562	.188	.250	.141	.373 .371
1/2	3/8	16	.750	.250	.312	.188	.498 .496
5/8	1/2	13	.875	.312	.375	.234	.623 .621
3/4	5/8	11	1.000	.375	.500	.281	.748 .746
1	3/4	10	1.312	.500	.625	.375	.998 .996
1 1/4	7/8	9	1.750	.625	.750	.469	1.248 1.246
1 1/2	1 1/8	7	2.125	.875	1.000	.656	1.498 1.496
1 3/4	1 1/4	7	2.375	1.000	1.125	.750	1.748 1.746
2	1 1/2	6	2.750	1.250	1.250	.937	1.998 1.996

Body size nom.	Thread Length				
	G max.	K min	I max	F max	E max
1/4	.142	.227	.083	.093	.375
5/16	.193	.289	.100	.093	.438
3/8	.249	.352	.111	.093	.500
1/2	.304	.477	.125	.093	.625
5/8	.414	.602	.154	.093	.750
3/4	.521	.727	.182	.093	.875
1	.638	.977	.200	.125	1.000
1-1/4	.750	1.227	.222	.125	1.125
1-1/2	.964	1.478	.286	.125	1.500
1-3/4	1.089	1.728	.286	.125	1.750
2	1.307	1.978	.333	.125	2.000

NOTES

Concentricity: Head to body – within .005 T.I.R. when checked in "V" block equal to or longer than body length. Pitch diameter to body – within .004 T.I.R. when held in threaded bushing and checked at a distance of 3/16" from shoulder at threaded end.

Shoulder must rest against face of shoulder of standard "GO" ring gage.
 Bearing surface of head – perpendicular to axis of body within 2° maximum deviation.

Tensile strength based on minimum neck area "G." Shear strength based on shoulder diameter "D."

Screw point chamfer: The point shall be flat or slightly concave, and chamfered. The plane of the point shall be approximately normal to the axis of the screw. The chamfer shall extend slightly below the root of the thread, and the edge between flat and chamfer may be slightly rounded. The included angle of the point should be approximately 90°.

Socket Head Shoulder Screws - Inch



HIGH-GRADE ALLOY STEEL

Size	Part No.		lbs. /1000
1/4" (#10-24) UNC - Key Size 1/8"			
1/4" x 3/8	103614	25	11.84
1/2	115475	25	13.55
5/8	115729	25	15.82
3/4	115859	25	16.96
1	102352	25	21.34
1 1/4	111469	25	23.80
1 1/2	117980	25	27.21
5/16" (1/4-20) UNC - Key Size 5/32"			
5/16" x 3/8	118045	25	19.51
1/2	114047	25	22.20
5/8	117628	25	24.88
3/4	106137	25	27.54
1	106201	25	32.91
1 1/4	106266	25	38.26
1 1/2	106331	25	43.63
1 3/4	106395	25	48.97
2	106459	25	54.34
3/8" (5/16-18) UNC - Key Size 3/16"			
3/8" x 3/8	106524	25	33.77
1/2	111791	25	37.64
5/8	116768	25	41.49
3/4	116800	25	45.36
1	110993	25	53.09
1 1/4	111025	25	60.83
1 1/2	118465	25	68.55
1 3/4	114133	25	76.30
2	114166	25	84.02
2 1/4	114200	25	91.74
2 1/2	114233	25	99.48
2 3/4	119970	25	107.21
3	120003	25	114.95
3 1/4	120036	25	122.67
3 1/2	120069	25	130.39
3 3/4	120101	25	138.14
4	118103	25	145.86
1/2" (3/8-16) UNC - Key Size 1/4"			
1/2" x 1/2	119560	25	74.36
5/8	107602	25	81.25
3/4	107634	25	88.13
1	113288	25	101.90
1 1/4	106400	25	115.70
1 1/2	106432	25	129.47
1 3/4	106465	25	143.26
2	106497	25	157.04
2 1/4	113444	25	170.81
2 1/2	113476	25	184.60

Size	Part No.		lbs. /1000
1/2" (3/8-16) UNC - Key Size 1/4"			
1/2" x 2 3/4	113509	25	198.37
3	102884	25	212.17
3 1/4	111946	25	225.94
3 1/2	111978	25	239.71
3 3/4	112011	25	253.51
4	108444	25	267.28
4 1/4	108477	25	281.07
4 1/2	108510	10	294.84
4 3/4	108544	10	308.62
5	102921	10	322.41
5 1/2	116309	10	349.98
6	116311	10	377.52
5/8" (1/2-13) UNC - Key Size 5/16"			
5/8" x 1	115741	25	169.47
1 1/4	102954	25	191.03
1 1/2	107083	25	212.61
1 3/4	107114	25	234.17
2	107147	25	255.73
2 1/4	104292	25	277.31
2 1/2	104359	25	298.87
2 3/4	110484	25	320.43
3	109843	25	342.01
3 1/4	103662	25	363.57
3 1/2	103728	25	385.13
3 3/4	117089	10	406.71
4	119174	10	428.27
4 1/4	114672	10	449.83
4 1/2	114737	10	471.39
4 3/4	119201	10	492.98
5	106617	10	514.54
5 1/2	119573	10	557.68
6	119605	10	600.80
6 1/2	116312	10	643.94
7	116313	10	687.08
3/4" (5/8-11) UNC - Key Size 3/8"			
3/4" x 3/4	102298	25	241.18
1	102365	25	272.27
1 1/4	102397	25	303.38
1 1/2	108998	10	334.47
1 3/4	125809	10	365.55
2	113145	10	396.00
2 1/4	107658	10	427.72
2 1/2	107690	10	458.83
2 3/4	107722	10	489.92
3	113244	10	521.00
3 1/4	107461	10	552.09
3 1/2	107493	10	583.18

Size	Part No.		lbs. /1000
3/4" (5/8-11) UNC - Key Size 3/8"			
3/4" x 3 3/4	107525	10	614.26
4	107557	10	645.37
4 1/4	107590	10	676.46
4 1/2	107622	10	707.54
4 3/4	113276	10	738.63
5	113308	10	769.71
5 1/2	106420	10	831.91
6	106452	10	894.08
6 1/2	117921	10	956.25
7	117938	10	1018.45

Note:

The nominal diameter of a shoulder screw is the diameter of the shoulder, and not the thread diameter, but it is recommended that both are quoted when ordering. Eg 1/2 x 5/8 UNC x 1

FLAT HEAD COUNTERSUNK SOCKET SCREWS

Unbrako
THE WORLD LEADER

HIGH-GRADE ALLOY STEEL

Modern equipment and machinery requires stronger more reliable joints to hold their parts together - and stronger more reliable fasteners.

That's why Unbrako countersunk screws are so widely used for fastening of plates, strips, mouldings, and other thin section parts. Unbrako countersunk screws provide reliable fastening and a smooth, attractive, flush mounting that enhances the appearance of the product on which they are used.

Unbrako countersunk screws provide more clamping force because they are manufactured from high grade alloy steel, and held to exacting tolerances to ensure the highest degree of dimensional uniformity. The closely controlled head angle assures flush seating, and close all-round head contact by initially contacting at the upper portion of the head bearing area in the countersunk hole. Closely controlled threads mean tighter and more secure fits, and stronger assemblies. Deep accurate non-slip sockets provide maximum key engagement for full tightening without marring the surrounding surface.

Unbrako countersunk screws are available with either plain or plated finish. Stainless steel screws are also available.



FEATURES

Precision forged head for continuous grain flow and maximum strength

Fully formed radiused threads rolled to maintain continuous grain flow for greater tensile and fatigue strength.

Heat treatment in a controlled atmosphere for maximum uniform strength and surface integrity without brittleness or decarburisation.



Uniform under-head angle gives maximum contact with side walls.

Radiused-root runout increases fatigue life.

Deep, accurate socket for uniform wrenching power and high maximum torques.



Controlled angle under the head ensures maximum flushness and side wall contact. Non-slip Hex socket prevents marring of material.

Equivalent Standards

ISO 10642, ASME B18.3.5M, DIN 7991, BS 4168-8

Mechanical Properties

Material: Unbrako High Grade Alloy Steel
 Property Class: 012.9
 Heat Treatment: Rc 39-44
 Shear Strength: 630 N/mm²
 Min. Elongation: 9%
 Tensile Strength: 1040 Mpa
 Shear Strength: 630 Mpa
 Yield Strength: 945 Mpa

Notes

1. Thread Class: ANSI B1.13M, ISO262
2. Working Temperature: -50°C to +300°C
3. For sizes up to and including M20 Head Angle shall be 92°/90°, over M20 Head Angle be 62°/60°.
4. Torque calculated in accordance with VDI2230 - "Systematic calculation of high duty bolted joints" with $\sigma 0.2 = 720\text{N/mm}^2$ and $\mu = .125$ for plain finish and $\mu = 0.094$ for plated.

Length 'L' Tolerance (mm)

Screws Over	Up to and including	Tolerance
-	50	±0.25
50	80	±0.50
80	120	±0.70
120	250	±0.80
250	-	±1.02

Head Marking

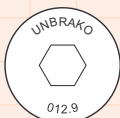

Head markings may vary slightly depending on manufacturing practice. UNBRAKO and UNB are recognized identifications for M5 diameter & larger.

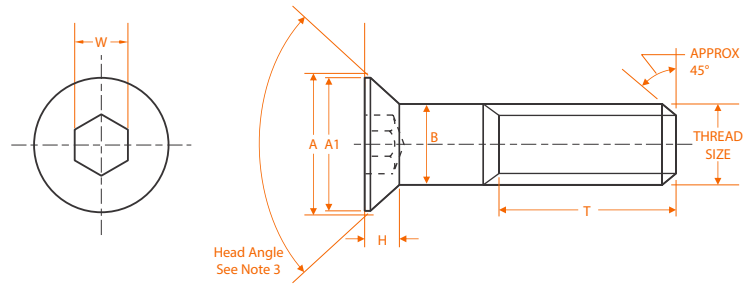

Product Dimensions

Thread size nom.	Pitch	Theoretical Diameter A max	Head Diameter A1 min	Body Dia B max	Hex Socket Size W nom.	Head Height H ref.	Thread Length T ref.
M3	0.50	6.72	5.82	2.98	2.0	1.86	18
M4	0.70	8.96	7.80	3.98	2.5	2.48	20
M5	0.80	11.2	9.78	4.98	3.0	3.10	22
M6	1.00	13.44	11.73	5.97	4.0	3.72	24
M8	1.25	17.92	15.73	7.97	5.0	4.96	28
M10	1.50	22.40	19.67	9.97	6.0	6.20	32
M12	1.75	26.88	23.67	11.97	8.0	7.44	36
(M14)	2.00	30.24	26.67	13.96	10.0	8.12	40
M16	2.00	33.60	29.67	15.96	10.0	8.80	44
(M18)	2.50	36.96	32.61	17.96	12.0	9.48	48
M20	2.50	40.32	35.61	19.96	12.0	10.11	52
(M22)	2.50	37.38	35.61	21.96	14.0	13.32	56
M24	3.00	40.42	38.61	23.96	14.0	14.22	60

Recommended Seating Torques				Tensile Load
Unplated		Plated		
N-m	lbf.in.	N-m	lbf.in.	kN
1.4	12	1.1	9	5.28
3.4	30	2.6	22	9.22
6.8	60	5.1	45	14.90
11.0	97	8.3	73	21.10
28.0	248	21.0	186	38.40
55.0	486	41.0	365	60.90
95.0	840	71.0	630	88.50
150.0	1,330	112.0	990	121.00
237.0	2,100	177.0	1,570	165.00
340.0	3,000	255.0	2,250	202.00
480.0	4,250	360.0	3,190	257.00
637.0	5,640	477.0	4,220	318.00
746.0	6,600	585.0	5,180	371.00

General Note: Flat, countersunk head cap screws and button head cap screws are designed and recommended for moderate fastening applications: machine guards, hinges, covers, etc. They are not suggested for use in critical high load strength applications where socket head cap screws should be used. Also due to their head configuration they may not meet the minimum ultimate tensile requirements for property class 12.9 as specified in EN ISO 898-1. They are nevertheless required to meet the other material and property requirements for property class 12.9.

Body and Grip Length Dimensions

- LG is the maximum grip length and is the distance from the bearing surface to the first complete thread.
- LB is the minimum body length and is the length of the unthreaded cylindrical portion of the shank.
- Dimensions for LB and LG are calculated from the following formula:

T Ref = (2x Nominal Dia) plus 12mm.

LG max = Nominal length "L" minus "T"

LB min = Nominal length "L" minus (T + 5 pitches)

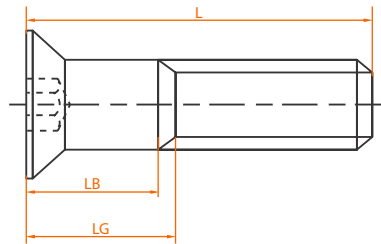



Length	M3		M4		M5		M6		M8		M10		M12	
L Nom.	L _B (min)	L _G (max)	L _B (min)	L _G (max)	L _B (min)	L _G (max)	L _B (min)	L _G (max)	L _B (min)	L _G (max)	L _B (min)	L _G (max)	L _B (min)	L _G (max)
30														
35	14.5	17.0	11.5	15.0										
40	19.5	22.0	16.5	20.0	14.0	18.0								
45	24.5	27.0	21.5	25.0	19.0	23.0	16.0	21.0						
50	29.5	32.0	26.5	30.0	24.0	28.0	21.0	26.0	15.75	22.0				
55	34.5	37.0	31.5	35.0	29.0	33.0	26.0	31.0	20.75	27.0				
60			36.5	40.0	34.0	38.0	31.0	36.0	25.75	32.0	20.5	28.0		
65			41.5	45.0	39.0	43.0	36.0	41.0	30.75	37.0	25.5	33.0	20.2	29.0
70			46.5	50.0	44.0	48.0	41.0	46.0	35.75	42.0	30.5	38.0	25.2	34.0
80			56.5	60.0	54.0	58.0	51.0	56.0	45.75	52.0	40.5	48.0	35.2	44.0
90					64.0	68.0	61.0	66.0	55.70	62.0	50.5	58.0	45.2	54.0
100					74.0	78.0	71.0	76.0	65.70	72.0	60.5	68.0	55.2	64.0
110							81.0	86.0	75.70	82.0	70.5	78.0	65.2	74.0
120							91.0	96.0	85.70	92.0	80.5	88.0	75.2	84.0
130									95.70	102.0	90.5	98.0	85.2	94.0
140									105.70	112.0	100.5	108.0	95.2	104.0
150									115.70	122.0	110.5	118.0	105.2	114.0

Length	M14		M16		M18		M20		M22		M24	
L Nom.	L _B (Max.)	L _G (Max.)	L _B (Max.)	L _G (Max.)	L _B (Max.)	L _G (Max.)	L _B (Max.)	L _G (Max.)	L _B (Max.)	L _G (Max.)	L _B (Max.)	L _G (Max.)
70	20.0	30.0										
80	30.0	40.0	26.0	36.0								
90	40.0	50.0	36.0	46.0	29.5	42.0						
100	50.0	60.0	46.0	56.0	39.5	52.0						
110	60.0	70.0	56.0	66.0	49.5	62.0	45.5	58.0				
120	70.0	80.0	66.0	76.0	59.5	72.0	55.5	68.0	51.5	64.0		
130	80.0	90.0	76.0	86.0	69.5	82.0	65.5	78.0	61.5	74.0	55.0	70.0
140	90.0	100.0	86.0	96.0	79.5	92.0	75.5	88.0	71.5	84.0	65.0	80.0
150	100.0	110.0	96.0	106.0	89.5	102.0	85.5	98.0	81.5	94.0	75.0	90.0
160			106.0	116.0	99.5	112.0	95.5	108.0	91.5	104.0	85.0	100.0
180			126.0	136.0	119.5	132.0	115.5	128.0	111.5	124.0	105.0	120.0
200					139.5	156.0	135.5	148.0	131.5	144.0	125.0	140.0
220									151.5	164.0	145.0	160.0
240											165.0	180.0

Countersunk Socket Head Screws- Metric



Size	Part No.		lbs. /1000
M3 (0.5) - Key Size 2mm			
M3 x 6	106283	200	0.84
8	103303	200	1.06
10	103304	200	1.25
12	103305	200	1.45
15	401672	200	1.76
16	103306	200	1.87
20	103308	200	2.27
25	106284	200	2.79
30	106285	200	3.30
M4 (0.7) - Key Size 2.5mm			
M4 x 8	103309	200	1.96
10	103311	200	2.33
12	103312	200	2.68
15	401674	200	3.23
16	103313	200	3.41
18	401675	200	3.76
20	103315	200	4.11
25	103316	200	5.02
30	103317	200	5.92
35	106287	200	7.44
40	106288	200	8.56
M5 (0.8) - Key Size 3mm			
M5 x 8	103318	200	3.30
10	103319	200	3.87
12	103320	200	4.44
14	401676	200	5.04
15	401660	200	5.32
16	103321	200	5.61
18	401677	200	6.18
20	103322	200	6.75
25	103323	200	8.18
30	103324	200	9.61
35	106289	200	11.04
40	106290	200	13.51
45	106293	200	15.22
50	106294	200	17.16
M6 (1) - Key Size 4mm			
M6 x 8	103325	200	5.08
10	103328	200	5.90
12	103329	200	6.71
14	401678	200	7.55
15	401661	200	7.94
16	103330	200	8.36
18	401679	200	9.17
20	103331	200	9.99
25	103332	200	12.03

Size	Part No.		lbs. /1000
M6 (1) - Key Size 4mm			
M6 x 30	103333	200	14.08
35	103334	200	16.13
40	103335	200	18.17
45	106295	200	20.04
50	106296	200	24.53
M8 (1.25) - Key Size 5mm			
M8 x 10	103336	200	11.70
12	103337	200	13.18
15	401680	200	15.40
16	103338	200	16.15
18	401681	200	17.62
20	103340	200	19.10
25	103341	200	22.77
30	103342	200	26.47
35	103343	200	30.16
40	103344	200	33.86
45	106297	200	37.53
50	106298	200	44.62
55	106299	100	49.66
60	106300	100	53.53
70	106301	100	62.44
M10 (1.5) - Key Size 6mm			
M10 x 12	103345	200	23.41
16	103347	200	28.05
20	103348	200	32.71
25	103349	200	38.52
30	103350	200	44.35
35	103351	200	50.16
40	103352	100	55.99
45	106302	100	61.80
50	106303	100	67.63
55	106304	100	73.44
60	106305	100	85.93
70	106306	50	99.57
80	106308	50	113.98
90	106309	50	128.00
100	106310	50	142.03
M12 (1.75) - Key Size 8mm			
M12 x 20	103353	100	48.07
25	103354	100	56.50
30	103355	100	64.92
35	103356	100	73.37
40	103357	100	81.80
45	106311	100	90.22
50	103358	50	98.65
55	106312	50	107.07

Size	Part No.		lbs. /1000
M12 (1.75) - Key Size 8mm			
M12 x 60	106313	50	115.50
70	106314	50	143.99
80	106315	50	163.68
90	106316	50	184.56
100	106330	50	204.82
M16 (2) - Key Size 10mm			
M16 x 30	103359	50	118.60
35	103360	50	134.05
40	103361	50	149.47
45	106318	50	164.91
50	103362	50	180.36
55	106320	25	195.78
60	103363	25	211.22
70	106321	25	242.09
80	106322	25	291.87
M20 (2.5) - Key Size 12mm			
M20 x 35	106328	25	211.97
40	106332	25	236.10
45	106334	25	260.22
50	106335	25	284.35
60	106337	25	332.60
70	106338	25	380.82
80	106339	25	429.07
100	106342	25	525.56
120	401685	10	676.37
140	401686	10	788.83
160	401687	10	901.30
M24 (3) - Key Size 14mm			
M24 x 50	220032	10	407.00
100	401693	10	721.60
120	183179	10	857.34

Sizes above the bold line are threaded to head.

Countersunk Socket Head Screws

UNC/UNF

Inch



Controlled angle under the head ensures maximum flushness and side wall contact. Non-slip Hex socket prevents marring of material.

Equivalent Standards

BS 2470, ANSI B18.3

Mechanical Properties

Material: ASTM F835

Hardness: Rc 39–43

Tensile Strength: 96,000 lbf/in² min.

Length Tolerance

Diameter	to 1"	over 1"	over 2 1/2"
		to 2 1/2"	to 6"
#0 to 3/8" incl.	-.03	-.04	-.06
7/16 to 3/4" incl.	-.03	-.06	-.08
7/8 to 1" incl.	-.05	-.10	-.14

Application Data

Thread size nom.	Maximum Tightening Torques			
	Unplated		Plated	
	UNC	UNF	UNC	UNF
#0	-	1.6	-	1.2
#1	2.6	2.9	1.9	2.1
#2	4.4	4.8	3.3	3.6
#3	6.7	8.5	5.0	6.3
#4	8.9	10.0	6.6	7.5
#5	13.0	14.0	9.0	10.0
#6	16.0	19.0	12.0	14.0
#8	30.0	32.0	22.0	24.0
#10	44.0	51.0	33.0	38.0
1/4	100.0	120.0	75.0	90.0
5/16	210.0	240.0	157.0	180.0
3/8	380.0	430.0	285.0	322.0
7/16	600.0	680.0	450.0	510.0
1/2	930.0	1,050.0	697.0	787.0
5/8	1,800.0	2,000.0	1,350.0	1,500.0
3/4	3,200.0	3,560.0	2,400.0	2,670.0
7/8	5,400.0	6,000.0	4,050.0	4,500.0
1	8,200.0	8,900.0	6,150.0	6,675.0

Head Marking

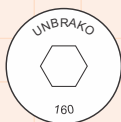

Head markings may vary slightly depending on manufacturing practice. UNBRAKO, and UNB are recognized identifications for #10 diameter & larger.

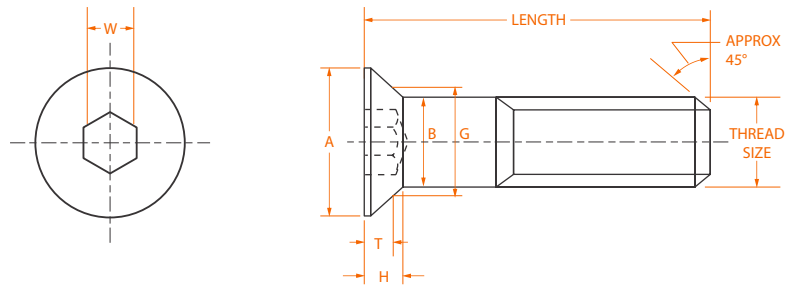

Product Dimensions

Thread size nom.	Thread per Inch		Head Diameter A		Hex Socket Size W nom.	Head Height H max ref.	Socket Depth T min.
	UNC	UNF	max*	min**			
#0	-	80	.138	.117	.035	.044	.025
#1	64	72	.168	.143	.050	.054	.031
#2	56	64	.197	.168	.050	.064	.038
#3	48	56	.226	.193	.0625	.073	.044
#4	40	48	.255	.218	.0625	.083	.055
#5	40	44	.281	.240	.0781	.090	.061
#6	32	40	.307	.263	.0781	.097	.066
#8	32	36	.359	.311	.0937	.112	.076
#10	24	32	.411	.359	.1250	.127	.087
1/4	20	28	.531	.480	.1562	.161	.111
5/16	18	24	.656	.600	.1875	.198	.135
3/8	16	24	.781	.720	.2187	.234	.159
7/16	14	20	.844	.781	.2500	.234	.159
1/2	13	20	.938	.872	.3125	.251	.172
5/8	11	18	1.188	1.112	.3750	.324	.220
3/4	10	16	1.438	1.355	.5000	.396	.220
7/8	9	14	1.688	1.604	.5625	.468	.248
1	8	12	1.938	1.841	.6250	.540	.297

* maximum – to theoretical sharp corners
**minimum – absolute with A flat

Thread size nom.	thd-to-hd max ref	Body Diameter B		Protrusion gage diameter G		Tensile Load lbf	
		max	min	max	min	UNC	UNF
#0	.500	.060	.0568	.078	.077	-	265
#1	.750	.073	.0695	.101	.100	390	390
#2	.750	.086	.0822	.124	.123	555	555
#3	.750	.099	.0949	.148	.147	725	725
#4	.875	.112	.1075	.172	.171	960	1,040
#5	.875	.125	.1202	.196	.195	1,260	1,310
#6	.875	.138	.1329	.220	.219	1,440	1,620
#8	1.000	.164	.1585	.267	.266	2,220	2,240
#10	1.250	.190	.1840	.313	.312	2,780	3,180
1/4	1.250	.250	.2435	.424	.423	5,070	5,790
5/16	1.500	.3125	.3053	.539	.538	8,350	9,250
3/8	1.750	.375	.3678	.653	.652	12,400	14,000
7/16	2.000	.4375	.4294	.690	.689	16,900	18,900
1/2	2.250	.500	.4919	.739	.738	22,800	25,600
5/8	2.500	.625	.6163	.962	.961	36,000	40,800
3/4	3.000	.750	.7406	1.186	1.185	53,200	59,300
7/8	3.250	.875	.8647	1.411	1.410	73,500	81,000
1	3.750	1.000	.9886	1.635	1.634	96,300	106,000

GENERAL NOTE: Flat, countersunk head cap screws and button head cap screws are designed and recommended for moderate fastening applications: machine guards, hinges, covers, etc. They are not suggested for use in critical high load strength applications where socket head cap screws should be used.

HIGH-GRADE ALLOY STEEL

Maximum Lengths

- LG is the maximum grip length and is the distance from the bearing surface to the first complete thread.

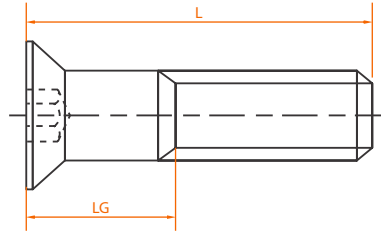



Thread Size	Length 'L'																			
	3/4	7/8	1	1 1/4	1 1/2	1 3/4	2	2 1/4	2 1/2	2 3/4	3	3 1/4	3 1/2	3 3/4	4	4 1/4	4 1/2	4 3/4	5	
# 0	0.25	0.25	0.50	0.75																
# 1		0.25	0.25	0.62	0.88															
# 2		0.25	0.25	0.62	0.88	1.12														
# 3		0.25	0.25	0.62	0.88	1.12	1.38													
# 4				0.50	0.50	1.00	1.00	1.50												
# 5				0.50	0.50	1.00	1.00	1.50												
# 6				0.50	0.50	1.00	1.00	1.50	1.50	2.00										
# 8				0.38	0.38	0.88	0.88	1.38	1.38	1.88	1.88	2.38								
# 10					0.62	0.62	1.12	1.12	1.62	1.62	2.12	2.12	2.62	2.62	3.12					
1/4					0.75		0.75	1.25	1.25	1.75	1.75	2.25	2.25	2.75	2.75	3.25	3.25	3.75	3.75	
5/16							0.88	0.88	1.38	1.38	1.88	1.88	2.38	2.38	2.88	2.88	3.38	3.38	3.88	
3/8								1.00	1.00	1.50	1.50	2.00	2.00	2.50	2.50	3.00	3.00	3.50	3.50	
7/16									1.12	1.12	1.62	1.62	2.12	2.12	2.62	2.62	3.12	3.12	3.62	
1/2									1.00	1.00	1.00	1.75	1.75	1.75	2.50	2.50	2.50	3.25	3.25	
5/8											1.50	1.50	1.50	2.25	2.25	2.25	3.00	3.00		
3/4												1.50	1.50	1.50	1.50	2.50	2.50	2.50	2.50	
7/8													1.50	1.50	1.50	1.50	2.50	2.50	2.50	
1														1.50	1.50	1.50	1.50	2.50	2.50	

Countersunk Socket Head Screws

UNC/UNF



Size	Part No.		lbs. /1000
#4-40 UNC - Key Size 1/16"			
#4 x 1/4	104414	100	0.84
3/8	104447	100	1.10
1/2	104480	100	1.36
5/8	103424	100	1.61
3/4	103457	100	1.89
#5-40 UNC - Key Size 5/64"			
#5 x 1/4	121026	100	1.06
3/8	107506	100	1.39
1/2	107615	100	1.74
5/8	113269	100	1.94
3/4	119592	100	2.40
#6-32 UNC - Key Size 5/64"			
#6 x 1/4	119626	100	1.32
3/8	119658	100	1.72
1/2	119691	100	2.13
5/8	119725	100	2.51
3/4	119759	100	2.93
1	105351	100	3.37
#8-32 UNC - Key Size 3/32"			
#8 x 3/8	106645	100	2.60
1/2	106677	100	3.19
5/8	106709	100	3.78
3/4	106741	100	4.38
1	106773	100	5.59
#10-24 UNC - Key Size 1/8"			
#10 x 3/8	106805	100	3.43
1/2	113654	100	4.20
5/8	113687	100	4.97
3/4	113719	100	5.74
1	120686	100	7.26
1 1/4	118712	100	8.80
1 1/2	108955	100	11.62
#10-32 UNF - Key Size 1/8"			
#10 x 3/8	111890	100	3.59
1/2	111889	100	4.42
5/8	113158	100	5.26
3/4	107655	100	6.09
1	107671	100	7.77
1 1/4	107687	100	9.44
1 1/2	111818	100	12.03
1/4-20 UNC - Key Size 5/32"			
1/4 x 3/8	105257	100	6.93
1/2	105289	100	8.32
5/8	105321	100	9.70

Size	Part No.		lbs. /1000
1/4-20 UNC - Key Size 5/32"			
1/4 x 3/4	105352	100	11.09
1	118658	100	13.86
1 1/4	120514	100	16.63
1 1/2	120581	100	19.40
1 3/4	120645	100	23.21
2	118672	100	27.26
1/4-28 UNF - Key Size 5/32"			
1/4 x 3/8	111834	100	7.19
1/2	108107	100	8.71
5/8	104289	100	10.21
3/4	104322	100	11.73
1	104356	100	14.72
1 1/4	115174	100	17.73
1 1/2	107581	100	20.75
5/16-18 UNC - Key Size 3/16"			
5/16 x 1/2	120341	100	14.23
5/8	119485	100	16.41
3/4	119517	100	18.59
7/8	106770	100	19.51
1	105918	100	22.95
1 1/4	105951	100	27.32
1 1/2	105983	100	31.68
1 3/4	106015	100	36.04
2	106046	100	44.73
2 1/4	106079	100	47.76
2 1/2	117115	100	50.80
5/16-24 UNF - Key Size 3/16"			
5/16 x 1/2	114970	100	14.83
5/8	103930	100	17.20
3/4	103326	100	18.59
1	115218	100	24.35
1 1/4	115282	100	29.13
1 1/2	115345	100	33.90
3/8-16 UNC - Key Size 7/32"			
3/8 x 1/2	117147	100	22.40
5/8	117179	100	23.85
3/4	107104	100	28.91
7/8	118253	100	32.12
1	107136	100	35.40
1 1/4	104272	100	41.80
1 1/2	104338	100	48.38
1 3/4	110464	100	54.87
2	108160	100	65.74
2 1/4	109890	50	73.17
2 1/2	103706	50	80.61
3	104929	50	96.73

Size	Part No.		lbs. /1000
3/8-24 UNF - Key Size 7/32"			
3/8 x 5/8	115416	100	23.85
3/4	103388	100	30.32
1	103420	100	37.40
1 1/4	106866	100	44.48
1 1/2	106896	100	51.57
7/16-14 UNC - Key Size 7/32"			
7/16 x 3/4	104993	100	35.22
1	116833	100	43.63
1 1/4	116897	50	35.42
1 1/2	102033	50	63.40
1 3/4	105097	50	68.86
2	116228	50	72.47
1/2-13 UNC - Key Size 5/16"			
1/2 x 3/4	115671	100	45.06
1	102630	100	60.85
1 1/4	107321	50	72.71
1 1/2	107353	50	84.57
1 3/4	120801	50	96.40
2	106977	50	108.26
2 1/4	106992	50	112.11
2 1/2	107007	25	142.16
3	107038	25	165.88
1/2-20 UNF - Key Size 5/16"			
1/2 x 3/4	106925	100	51.19
1	106955	100	64.00
1 1/4	106985	50	76.78
1 1/2	107015	50	89.58
1 3/4	107046	50	102.37
2	107076	50	115.17
5/8-11 UNC - Key Size 3/8"			
5/8 x 1 1/4	107053	25	122.94
1 1/2	107923	25	141.70
1 3/4	120818	25	160.45
2	107955	25	179.21
2 1/4	107971	25	197.96
2 1/2	107989	25	208.53
3	120848	25	254.21
3/4-10 UNC - Key Size 1/2"			
3/4 x 1 1/4	102419	25	262.37
1 1/2	102436	25	219.14
1 3/4	102453	25	226.03
2	102469	25	251.50
2 1/4	102486	25	283.49
2 1/2	102502	25	329.01
3	102535	25	383.94
4	701531	25	475.20

WHAT YOU BUILD IS ONLY AS GOOD AS WHAT HOLDS IT TOGETHER

High Strength Structural Bolts
Tension Control Structural Bolts
A325 / A490
BS EN 14399, 15048
Arc Welding Studs
Rebar Couplers

Special Orders Only

Your application demands a fastener which outperforms all others. At Unbrako, our fasteners incorporate fully formed radiused heads, rolled to maintain continuous grain flow for increased fatigue strength. It is part of our commitment to giving you the very best in every way.

It's what makes us number one in the world of fasteners with unparalleled engineering knowledge, design ingenuity and manufacturing ability.



Buld with Strength

BUTTON HEAD CAP SCREWS

Unbrako button head screws are ideally suited for use in materials too thin to countersink and in non-critical loading applications. Their low head profile gives them smooth, aesthetic appearance, and their deep accurate sockets ensure non-slip wrench engagement to prevent marring of the surface in which they are installed.

Unbrako button head screws are made from high grade alloy steel and every manufacturing operation is closely controlled. Heads are forged for greater strength and full formed radius-root rolled threads assure close tolerances, maximum strength and superior fatigue resistance. Deep accurate sockets allow full tightening, and customized heat treatment of each heat of steel ensures maximum strength and hardness without brittleness.

FEATURES & BENEFITS

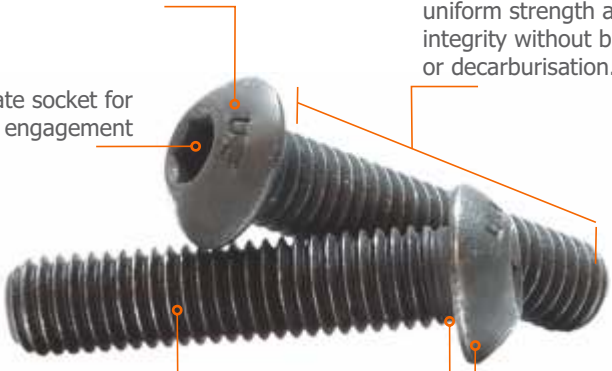

Low head profile for enhanced in situ appearance.

Heat treatment in a controlled atmosphere for maximum uniform strength and surface integrity without brittleness or decarburisation.

Deep, accurate socket for maximum key engagement

Fully formed radiused threads rolled to maintain continuous grain flow for greater tensile and fatigue strength.

Radiused-root runout increases fatigue life.

Precision forged head for continuous grain flow and maximum strength.



GENERAL NOTE

Flat, countersunk head cap screws and button head cap screws are designed and recommended for moderate fastening applications: machine guards, hinges, covers, etc. These are not suggested for use in critical high strength applications where socket head cap screws should be used.



Low head streamline design. Use them in materials too thin to countersink; also for non-critical loading requiring heat treated screws

Equivalent Standards

ISO 7380, ASME B18.3.4M, BS 4168-4

Mechanical Properties

1. Material: ASTM F835M, EN ISO 898-1
2. Dimensions: B18.3.4M
3. Property Class: 12.9
4. Hardness: Rc 39-44
5. Tensile Stress: 1040MPa
6. Shear Stress: 630 Mpa
7. Yield Stress: 945 Mpa
8. Working temperature: -50°C to +300°C
9. Bearing surface: To be square with body within 2°.
10. Thread Class: 4g 6g
11. Min Elongation 9%
12. Length Tolrence +/- 0.25MM
13. Torques Calculated In Accordance With VDI 2230

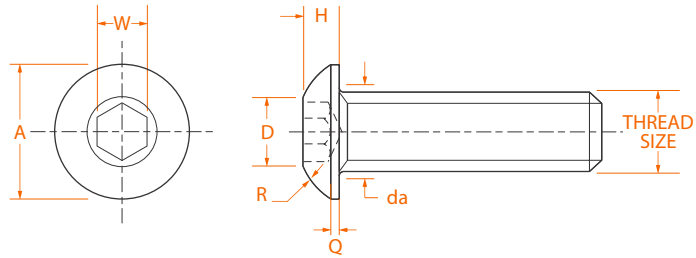

Product Dimensions

Thread size nom.	Pitch	Head Diameter	Transition dia	Head Height	Hex Socket Size		
		A max	da max	H max.	Q max	R ref.	W nom.
M3	0.50	5.70	3.60	1.65	.38	3.00	2.0
M4	0.70	7.60	4.70	2.20	.38	4.20	2.5
M5	0.80	9.50	5.70	2.75	.50	5.20	3.0
M6	1.00	10.50	6.80	3.30	.80	5.60	4.0
M8	1.25	14.00	9.20	4.40	.80	7.50	5.0
M10	1.50	17.50	11.20	5.50	.80	10.00	6.0
M12	1.75	21.00	13.70	6.60	.80	11.00	8.0

Recommended Tightening Torque

Unplated				Plated		Tensile Load kN
Nm	lbf.in	Nm	lbf.in			
1.4	12	1.1	9		5.28	
3.4	30	2.6	22		9.22	
6.8	60	5.1	45		14.90	
11.0	97	8.3	73		21.10	
28.0	248	21.0	186		38.40	
55.0	486	41.0	363		60.90	
95.0	840	71.0	630		88.50	

General Note: Flat, countersunk head cap screws and button head cap screws are designed and recommended for moderate fastening applications: machine guards, hinges, covers, etc. They are not suggested for use in critical high strength applications where socket head cap screws should be used. Also due to their head configuration they may not meet the minimum ultimate tensile requirements for property class 12.9 as specified in EN ISO 898-1. They are nevertheless required to meet the other material and property requirements for property class 12.9.

Head Marking





Head markings may vary slightly depending on manufacturing practice. UNBRAKO, and UNB are recognized identifications for M5 diameter & larger.

Button Head Socket Screws - Metric



Black / Plain

Size	Part No.		lbs. /1000
M3 (0.5) - Key Size 2mm			
M3 x 5	180248	200	0.97
6	106353	200	1.06
8	106354	200	1.25
10	106357	200	1.45
12	106358	200	1.65
16	106359	200	2.02
M4 (0.7) - Key Size 2.5mm			
M4 x 6	180200	200	2.16
8	106360	200	2.49
10	106361	200	2.84
12	106363	200	3.17
15	401218	200	3.67
16	106364	200	3.85
M5 (0.8) - Key Size 3mm			
M5 x 6	180398	200	3.83
8	180175	200	4.38
10	106365	200	4.93
12	106366	200	5.48
15	401219	200	6.29
16	106367	200	6.56
18	406269	200	7.11
20	106368	200	7.63
22	401220	200	8.18
25	106369	200	9.00
30	106370	200	10.36
M6 (1) - Key Size 4mm			
M6 x 8	180249	200	5.74
10	106372	200	7.15
12	106373	200	7.92
15	401222	200	9.09
16	106374	200	9.48
18	401223	200	10.25
20	106375	200	11.02
25	106376	200	12.96
30	106378	200	14.92
M8 (1.25) - Key Size 5mm			
M8 x 10	106379	200	14.74
12	106380	200	16.13
15	401226	200	18.24
16	106382	200	18.94
20	106384	200	21.74
25	106385	200	25.23

Size	Part No.		lbs. /1000
M8 (1.25) - Key Size 5mm			
M8 x 30	106386	200	28.73
35	106389	200	32.23
40	106390	200	35.73
M10 (1.5) - Key Size 6mm			
M10 x 16	106392	200	32.82
20	106393	200	37.25
25	106396	200	42.75
30	106399	200	48.27
35	106401	200	53.79
40	106402	100	59.29
M12 (1.75) - Key Size 8mm			
M12 x 16	106403	100	52.47
20	106404	100	58.85
25	106405	100	66.84
30	106406	100	74.84
35	106407	100	82.83
40	106408	50	84.66
50	106413	50	106.79

Note:
 • All button head socket screws are supplied with full thread.



Low heads streamline design. Use them in materials too thin to countersink; also for non-critical loading requiring heat treated screws

Equivalent Standard

ASME B18.3, BS 2470

Mechanical Properties

Material: Unbrako High Grade Alloy Steel
 Thread Class: 3A
 Max working temperature: -50°C to +300°C
 Heat Treatment: Rc 39-44
 Shear Strength: 96,000 lbf/in2
 Min. Elongation: 9%

Length Tolerance

Diameter	to 1" Incl.	over 1" to 2" Incl.
To 1" incl.	-.03	-.04
Over 1" to 2"	-.03	-.06

Maximum Tightening Torques

Thread size nom.	Unplated		Plated	
	UNF	UNC	UNF	UNC
Maximum Tightening Torques (lbf. in.)				
#4	8.9	10	6.6	7.5
#5	13.0	14	9.7	10.0
#6	16.0	19	12.0	14.0
#8	30.0	32	22.0	24.0
#10	44.0	51	33.0	38.0
1/4	100.0	120	75.0	90.0
5/16	210.0	240	157.0	180.0
Maximum Tightening Torques (lbf. ft.)				
3/8	380.0	430	285.0	322.0
7/16	600.0	680	450.0	510.0
1/2	930.0	1050	697.0	787.0
5/8	1800.0	2000	1350.0	1500.0
3/4	3200.0	3560	2400.0	2670.0

Head Marking



Head markings may vary slightly depending on manufacturing practice. UNBRAKO and UNB are recognized identifications for #10 diameter & larger.

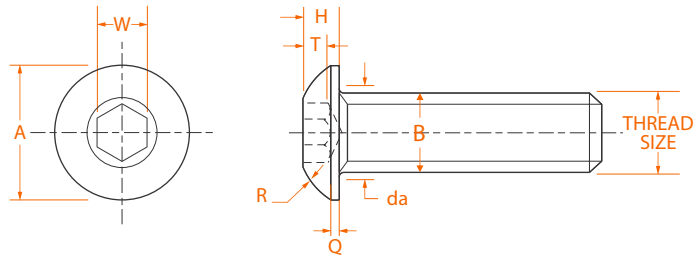

Product Dimensions

Thread size nom.	Threads per Inch		Head Diameter A		Hex Socket Size W	Head Height H		Socket Depth T
	UNC	UNF	max	min	min.	max	min	min
#0	-	80	.114	.104	.035	.032	.026	.020
#1	64	72	.139	.129	.050	.039	.033	.028
#2	56	64	.164	.154	.050	.046	.038	.028
#3	48	56	.188	.176	.0625	.052	.044	.035
#4	40	48	.213	.201	.0625	.059	.051	.035
#5	40	44	.238	.226	.0781	.066	.058	.044
#6	32	40	.262	.250	.0781	.073	.063	.044
#8	32	36	.312	.298	.0937	.087	.077	.052
#10	24	32	.361	.347	.1250	.101	.091	.070
1/4	20	28	.437	.419	.1562	.132	.122	.087
5/16	18	24	.547	.527	.1875	.166	.152	.105
3/8	16	24	.656	.636	.2187	.199	.185	.122
7/16	14	20	.750	.730	.2500	.232	.212	.138
1/2	13	20	.875	.851	.3125	.265	.245	.175
5/8	11	18	1.000	.970	.3750	.331	.311	.210
3/4	10	16	1.218	1.198	.5000	.398	.378	.272

Thread size nom.	thd. to hd max ref	Body Dia B		Q max	Transition Dia. da max		R ref	Tensile Load lbs.	
		max	min		max	min		UNC	UNF
#0	.500	.060	.0568	.010	.080	.070			
#1	.500	.073	.0695	.010	.093	.080			
#2	.500	.086	.0822	.010	.106	.099			
#3	.500	.099	.0949	.010	.119	.110			
#4	.500	.112	.1075	.015	.132	.135		960	1,040
#5	.500	.125	.1202	.015	.145	.141		1,260	1,310
#6	.625	.138	.1329	.015	.158	.158		1,440	1,620
#8	.750	.164	.1585	.015	.194	.185		2,220	2,240
#10	1.000	.190	.1840	.020	.220	.213		2,780	3,180
1/4	1.000	.250	.2435	.031	.290	.249		5,070	5,790
5/16	1.000	.3125	.3053	.031	.353	.309		8,350	9,250
3/8	1.250	.375	.3678	.031	.415	.368		12,400	14,000
7/16	1.500	.437	.4294	.031	.478	.417		16,900	18,900
1/2	2.000	.500	.4919	.046	.560	.481		22,800	25,600
5/8	2.000	.625	.6163	.062	.685	.523		36,000	40,800
3/4	2.000	.750	.7406	0.78	.810	.670		53,200	59,300

N.B. Because of their head configurations, Button head screw tensile loads, are based on 160,000 lbf/in2.

Button Head Socket Screws - Inch



Size	Part No.		lbs. /1000
#4-40 UNC - Key Size 1/16"			
#4 x 1/4	104704	100	0.90
5/16	107146	100	0.99
3/8	104720	100	1.14
1/2	104736	100	1.21
#6-32 UNC - Key Size 5/64"			
#6 x 1/4	104752	100	1.54
5/16	105496	100	1.63
3/8	104768	100	1.94
1/2	104784	100	2.31
5/8	104800	100	2.68
1	106565	100	3.72
#8-32 UNC - Key Size 3/32"			
#8 x 1/4	116546	100	2.44
3/8	116562	100	2.99
1/2	116579	100	3.56
5/8	116595	100	4.00
3/4	116611	100	4.69
#10-24 UNC - Key Size 1/8"			
#10 x 1/4	116932	100	3.34
3/8	116948	100	3.89
1/2	116964	100	4.80
5/8	109705	100	5.50
3/4	109722	100	6.25
7/8	103523	100	6.84
1	103539	100	7.72
#10-32 UNF - Key Size 1/8"			
#10 x 1/4	105400	100	3.48
3/8	102042	100	4.27
1/2	102058	100	5.06
5/8	120709	100	5.85
3/4	120725	100	6.47
7/8	120741	100	7.22
1	118647	100	8.23
1/4-20 UNC - Key Size 5/32"			
1/4 x 3/8	103556	100	7.04
1/2	110416	100	8.34
5/8	104174	100	9.64
3/4	104191	100	10.93
7/8	104209	100	12.25
1	103943	100	13.55
1 1/4	120415	100	16.15
1 1/2	120447	100	18.77

Size	Part No.		lbs. /1000
1/4-28 UNF - Key Size 5/32"			
1/4 x 1/4	114974	100	5.96
3/8	118664	100	7.37
1/2	120494	100	8.78
5/8	120527	100	10.19
3/4	120561	100	11.59
7/8	120593	100	13.00
1	120625	100	14.41
5/16-18 UNC - Key Size 3/16"			
5/16 x 3/8	103959	100	12.58
1/2	103975	100	14.70
5/8	103991	100	16.79
3/4	104007	100	18.90
7/8	104023	100	20.99
1	104040	100	23.10
1 1/4	119263	100	27.30
5/16-24 UNF - Key Size 3/16"			
5/16 x 3/8	701879	100	13.02
1/2	120690	100	15.27
5/8	118684	100	17.51
3/4	118716	100	19.78
1	120320	100	24.27
3/8-16 UNC - Key Size 7/32"			
3/8 x 1/2	104056	100	23.41
5/8	104072	100	26.49
3/4	108180	100	29.57
7/8	108197	100	32.65
1	108213	100	35.73
1 1/4	108229	100	41.91
1 1/2	113752	100	48.07
2	701845	100	60.41
3/8-24 UNF - Key Size 7/32"			
3/8 x 1/2	120353	100	24.42
3/4	119491	100	31.06
1	119523	100	37.73
1 1/4	183934	100	41.91
1/2-13 UNC - Key Size 5/16"			
1/2 x 3/4	106017	100	59.20
1	111721	50	70.38
1 1/4	111737	50	81.55
1 1/2	111753	50	92.40
2	111769	50	115.08

Size	Part No.		lbs. /1000
1/2-20 UNF - Key Size 5/16"			
1/2 x 1	108196	100	73.83
5/8-11 UNC - Key Size 3/8"			
5/8 x 1 1/4	111802	25	122.28
1 1/2	111819	25	148.83
2	111906	25	184.25

Note:
• All button head socket screws are supplied with full thread.

FLANGE BUTTON HEAD CAP SCREWS

Unbrako flange button head screws allow the covering of large diameter holes in sheet metal. As the large under head surface pressure by area is low, this fastener can also be used with softer materials without harm or damage. Flange button heads are ideal to fix strips, cover plates and sheet metal housings.

The radius on the button head presents a streamlined profile, virtually eliminating the sharp edges which could occur with a bolt and washer assembly.

Unbrako flange button head screws are available with metric threads and are made from high grade alloy steel.



FEATURES & BENEFITS

Precision forged head for continuous grain flow and maximum strength

Deep, accurate socket for uniform wrenching power and high maximum torques.

Heat treated in a controlled atmosphere for maximum uniform strength and surface integrity without brittleness or decarburisation

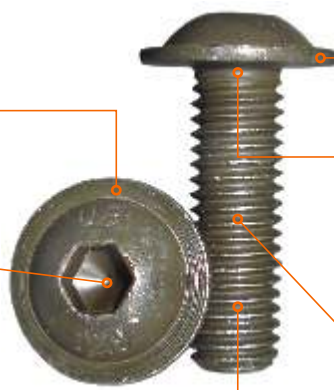

Flange facilitates greater load spread and streamlined appearance

Radiused root runout increases fatigue life

Fully formed radiused threads rolled to maintain continuous grain flow for greater tensile & fatigue strength



Allow covering of large diameter holes in sheet metal. Ideal to fix strips, cover plates and sheet metal housings.

Mechanical Properties

Material: Unbrako High Grade Alloy Steel
Heat Treatment: Rc 39-44

Notes

1. Thread Class: 4g 6g
2. Full thread length to within 2½ pitches of head.
3. Working Temperature: -50°C +300°C
4. Length tolerance = ±0.25mm.

5. Torques calculated in accordance with VDI 2230 "Systematic calculation of high duty bolted joints with $\sigma 0.2 = 720 \text{ N/mm}^2$ and $\mu = 0.125$ for plain finish.

Length Tolerance

Screws Over	Up to and including	Tolerance
-	1"	± 0.16"
1"	2"	+ 0.031" - 0.016"
2"	6"	± 0.031"
6"	-	± 0.062"

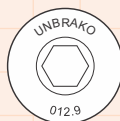

Head Marking

Head markings may vary slightly depending on manufacturing practice. UNBRAKO and UNB are recognized identifications for M5 diameter & larger.

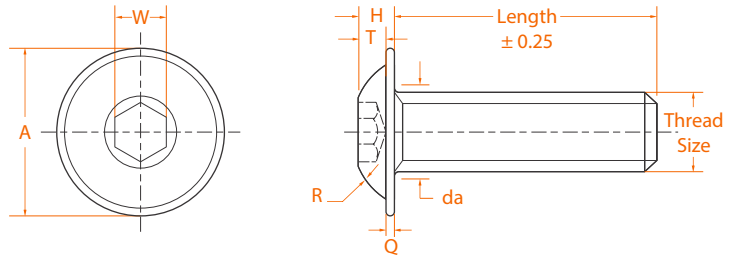

Product Dimensions

Thread Size	Pitch	Head Diameter A max.	Hex Socket Size W nom.	Head Height H max.	Socket Depth T min.	Transition Dia da max.	Q max.	R ref.
M3	0.50	7.12	2.0	1.65	1.05	3.60	0.70	3.00
M4	0.70	9.29	2.5	2.20	1.35	4.70	0.80	4.20
M5	0.80	11.40	3.0	2.75	1.92	5.70	0.90	5.20
M6	1.00	13.59	4.0	3.30	2.08	6.80	1.20	5.60
M8	1.25	17.00	5.0	4.40	2.75	9.20	1.30	7.50
M10	1.50	20.80	6.0	5.50	3.35	11.20	1.75	10.00
M12	1.75	24.69	8.0	6.60	4.16	13.70	2.40	11.00

Thread Size nom.	Recommended Tightening Torques Unplated		Tensile Loads kN
	N-m	lbf.in	
M3	1.96	18	5.23
M4	4.52	40	9.13
M5	9.08	80	14.77
M6	15.40	138	20.90
M8	36.80	330	38.06
M10	72.30	650	60.32
M12	126.00	1134	87.67



Allow covering of large diameter holes in sheet metal. Ideal to fix strips, cover plates and sheet metal housings.

Mechanical Properties

Heat Treatment: 40 - 43 HRC
Thread Class: 3A

Length Tolerance

Up to 1"	-0.03
Over 1" to 2 1/2"	-0.04
Over 2 1/2"	-0.06

Notes

*Thread Length: Screw lengths equal to or shorter than listed in column 'L' will be threaded to head

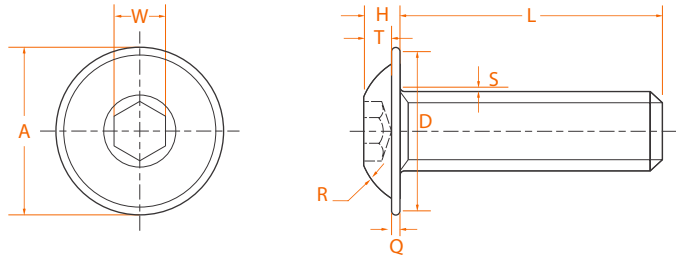

Product Dimensions

Thread Size	Threads per Inch		Head Diameter A max	Hex Socket Size W		Head Height H max	Socket Depth T min.
	nom.	UNC UNF		max	max		
#4	40	48	0.240	0.0635	0.0625	0.059	0.035
#6	32	40	0.292	0.0791	0.0781	0.073	0.044
#8	32	36	0.357	0.0952	0.0937	0.087	0.052
#10	24	32	0.407	0.1270	0.1250	0.101	0.070
1/4	20	28	0.560	0.1587	0.1562	0.132	0.087
5/16	18	24	0.680	0.1900	0.1875	0.166	0.105
3/8	16	24	0.810	0.2217	0.2187	0.199	0.122
1/2	13	20	1.070	0.3160	0.3125	0.265	0.175

Thread Size	Bearing Face D		Fillet Extension S max	Thread Length* L min
	min	Q max		
#4	0.203	0.025	0.140	0.500
#6	0.252	0.028	0.163	0.625
#8	0.312	0.031	0.190	0.750
#10	0.357	0.036	0.218	1.000
1/4	0.496	0.046	0.254	1.000
5/16	0.603	0.058	0.314	1.000
3/8	0.721	0.069	0.373	1.250
1/2	0.960	0.094	0.486	2.000

Head Marking



Head markings may vary slightly depending on manufacturing practice. UNBRAKO and UNB are recognized identifications for 1/4" diameter & larger.

Flange Button Head Socket Screws - Metric



Size	Part No.		lbs /1000
M3 (0.5) - Key Size 2mm			
M3 x 6	404977	200	1.23
M4 (0.7) - Key Size 2.5mm			
M4 x 8	404982	200	2.79
10	404983	200	3.15
12	404984	200	3.48
16	404986	200	4.16
M5 (0.8) - Key Size 3mm			
M5 x 10	404988	200	5.41
12	404989	200	5.96
16	404991	200	7.04
20	404992	200	8.12
25	404994	200	9.48
M6 (1) - Key Size 4mm			
M6 x 10	180079	200	8.36
12	404997	200	9.13
16	404999	200	10.69
20	405001	200	12.23

Size	Part No.		lbs /1000
M6 (1) - Key Size 4mm			
M6 x 25	405003	200	14.17
30	405004	200	16.13
M8 (1.25) - Key Size 5mm			
M8 x 10	405005	200	16.37
12	405007	200	17.78
16	405009	200	20.57
20	405011	200	23.36
25	405012	200	26.86
30	405013	200	30.36
40	405015	200	37.36
M10 (1.5) - Key Size 6mm			
M10 x 16	405016	200	35.82
20	405017	200	40.24
25	405018	200	45.76
30	405019	200	51.26

Flange Button Head Socket Screw - Inch



Size	Part No.		lbs /1000
#8-32 UNC - Key Size 3/32"			
#8 x 1/4	116376	100	3.04
3/8	116379	100	3.61
1/2	116381	100	4.18
#10-24 UNC - Key Size 1/8"			
#10 x 3/8	116391	100	4.86
1/2	116393	100	5.59
5/8	116395	100	6.34
3/4	116398	100	7.06
#10-32 UNF - Key Size 1/8"			
#10 x 3/8	116392	100	4.86
1/2	116394	100	5.59
3/4	116400	100	7.06

Size	Part No.		lbs /1000
1/4-20 UNC - Key Size 5/32"			
1/4" x 3/8	116406	100	9.46
1/2	116408	100	10.76
3/4	116413	100	13.35
1	116418	100	15.97
5/16-18 UNC - Key Size 3/16"			
5/16" x 3/8	116421	100	17.91
1/2	116423	100	20.02
5/8	116425	100	22.11
3/4	116427	100	24.22
1	116432	100	28.42
3/8-16 UNC - Key Size 7/32"			
3/8" x 1/2	116434	100	31.68
3/4	116439	100	37.84
1	116444	100	44.00
1 1/4	116446	100	50.16

Pieces per Box

All flange button head socket screws are supplied with full thread

The Unbrako logo consists of the word "Unbrako" in a bold, white, sans-serif font, set against a solid orange rectangular background.

NABL ISO/IEC 17025:2005
CERTIFIED LAB

PRECISION in Every Fastener

Unbrako Lab is equipped state-of-the-art equipment for testing of both physical and metallurgical aspects of fasteners for the most demanding industries:

- Tensile testing
- Hardness testing
- Salt spray testing
- Digital profile analysis
- X-ray analysis of coating thickness
- Impact Testing
- Chemical composition analysis (Spectrometer)
- Metallurgical Microscope with Image Analyzer
- Dynamic fatigue testing
- Torque tension and friction testing
- Eddy current Testing
- MCD Testing



SOCKET SET SCREWS

If you know set screws, you know that the tighter you can tighten them, the better they hold and the more they resist loosening from vibration. But there's a limit to how much you can tighten the average socket set screw. If you're not care-ful, you can ream or crack the socket, and in some cases, even strip the threads. So you're never quite sure whether or not it will actually stay tight. With UNBRAKO set screws it's a different story. A unique combination of design and carefully controlled manufacturing and heat treating gives these screws extra strength that permits you to tighten them appreciably tighter than ordinary screws with minimal fear of reaming or cracking the socket. This extra strength represents a substantial bonus of extra holding power and the additional safety and reliability that goes with it.

Design – Deeper UNBRAKO sockets give more key engagement to let you seat the screws tighter. Corners are radiused to safeguard against reaming or cracking the socket when the extra tightening torque is applied. The sharp corners of other set screws create high stress

concentrations and can cause cracking, even at lower tightening torques. By eliminating the corners, the radii distribute tightening stresses to reduce the chance of splitting to a minimum.

Controlled Manufacturing – The fully-formed threads of UNBRAKO set screws are rolled under extreme pressure to minimize stripping and handle the higher tightening torques. Also, with rolled threads, tolerances can be more closely maintained. Unbrako set screws

have Class 3A threads, closest interchangeable fit, giving maximum cross-section with smooth assembly. The thread form itself has the radiused root that increases the strength of the threads and resistance to shear.

Controlled Heat Treatment – This is the third element of the combination. Too little carbon in the furnace atmosphere (decarburization) makes screws soft, causing reamed sockets, stripped threads and sheared points when screws are tightened. Too much carbon (carburization) makes screws brittle and liable to crack or fracture. The heat treatment is literally tailored to each "heat" of UNBRAKO screws, maintaining the necessary controlled Rc 45-53 hardness for maximum strength. Finally, point style affects holding power. As much as 15% more can be contributed, depending on the depth of penetration. The cone point (when used without a spotting hole in the shaft) gives greatest increase because of its greater penetration. The plain cup point by far the most commonly used, because of the wide range of applications to which it is adaptable.

However, there is one cup point that can give you both a maximum holding power and of resistance to vibration. It is the exclusive UNBRAKO knurled cup point, whose locking knurls bite into the shaft and resist the tendency of the screw to back out of the tapped hole. The chart on this page shows clearly how much better the UNBRAKO set screws resist vibration in comparison with plain cup point set screws. UNBRAKO knurled cup point self-locking set screws give you excellent performance under conditions of extreme vibration.



SOCKET SET SCREWS



In contrast to other types of fasteners, set screws are primarily used in compression. They must hold fast against three types of forces, torsional (rotational), axial (lateral movement) and vibrational. To be effective, socket set screws should produce a strong clamping action which resists the relative motion between the assembled parts, because of the compression developed by tightening the set screw. Since holding power is proportional to seating torque, the tighter you can seat the screw, the higher the compression force will be.

But there is a limit to how much you can tighten the average set screw. If you're not careful, you'll ream or crack the socket, or strip the threads. So you're never sure if the screw is tight enough, and whether it will stay tight.

But you can be sure that Unbrako set screws will 'stay put' because you can tighten them until the key twists off, with no damage to the screws. Unbrako recommend tightening torques as much as 40% higher than other set screws, giving you extra holding power and additional safety and reliability. Unbrako socket set screws hold tighter because

they are stronger than other set screws. The superior strength and dimensional uniformity of Unbrako set screws permit use of consistently higher seating torques than with other set screws. Consequently you can often save money because you can reduce the size or the number of set screws you require in your assembly.

Here are some of the reasons why Unbrako set screws are so strong and stay tight. Unbrako set screws are made of high grade alloy steel and heat treated to a minimum hardness of Rc 45. Deep accurate sockets give more key engagement for extra wrenching areas. Radiused socket corners minimize points of weakness where cracks may start. Distribute stresses. Fully formed rolled threads provide greater strength and resistance to stripping. Controlled heat treatment assures uniform hardness without brittleness.

Unbrako socket set screws are available in knurled cup, cone, half dog, flat and plain cup point styles in plain or plated finishes. Stainless steel set screws are available in plain cup points only.

Fully formed threads – are rolled, not cut or ground. Metal is compressed, making it extra strong. Threads resist shearing, withstand higher tightening torques Class 3A threads – Formed with closest interchangeable fit for maximum cross section with smooth assembly. Assure better mating of parts

Radiused socket corners – Rounded corners resist cracking and allow UNBRAKO set screws to withstand high tightening torques

Counterbored knurled cup point – Exclusive UNBRAKO self-locking point provides 5 times greater vibrational holding power than other knurled points

Deep socket – Key fits deeply into socket to provide extra wrenching area for tighter tightening without reaming the socket or rounding off corners of key

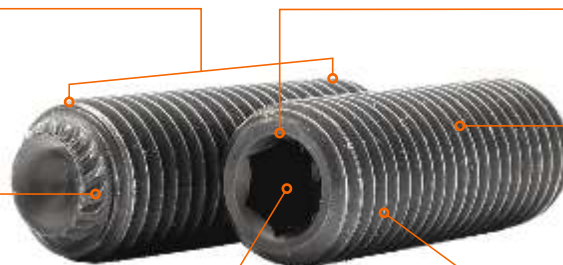

Continuous grain flow – Flow lines of rolled threads follow closely the contour of the screw

Balanced heat treatment – It's customized to individual lots of screws for uniform hardness, assuring maximum strength without brittleness

SOCKET SET SCREWS

Point Selection According To Application

Point selection is normally determined by the nature of the application – materials, their relative hardness, frequency of assembly and re-assembly and other factors. Reviewed here are standard point types, their general features and most frequent areas of application of each type.

KNURLED CUP

For quick and permanent location of gears, collars, pulleys or knobs on shafts. Exclusive counterclockwise locking knurls resist screw loosening, even in poorly tapped holes. Resists most severe vibration.

PLAIN CUP

Use against hardened shafts, in zinc, die castings and other soft materials where high tightening torques are impractical.

Torsional And Axial Holding Power Size selection of socket set screws

The user of a set-screw-fastened assembly is primarily buying static holding power. The data in this chart offers a simplified means for selecting diameter and seating torque of a set screw on a given diameter shaft. Torsional holding power in inch-pounds and axial holding power in pounds are tabulated for various cup point socket screws, seated at recommended installation torques. Shafting used was hardened to Rockwell C15. Test involved Class 3A screw threads in Class 2B tapped holes. Data was determined experimentally in a long series of tests in which holding power was defined as the minimum load to produce 0.010 inch relative movement of shaft and collar. From this basic chart, values can be modified by percentage factors to yield suitable design data for almost any standard set screw application.

CONE POINT

For permanent location of parts. Deep penetration gives highest axial and holding power. In material over Rockwell C15 point is spotted to half its length to develop shear strength across point. Used for pivots and fine adjustment.

HALF DOG POINT

Used for permanent location of one part to another. Point is spotted in hole drilled in shaft or against flat (milled). Often replaces dowel pins. Works well against hardened members or hollow tubing.

FLAT POINT

Use where parts must be frequently re-set, as it causes little or no damage to part it bears against. Can be used against hardened shafts (usually with ground flat for better contact) and as adjusting screw. Preferred for thin wall thickness and on soft plugs.

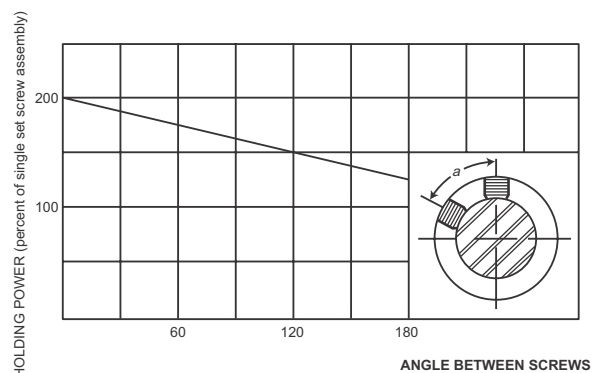

Socket Set Screws Knurled, Plain, Flat and Cone Point

Metric



Fasten collars, sheaves, gears, knobs on shafts. Locate machine parts. Self-locking knurled cup point is standard. Special Points like Flat, Dog, Cone & Plain Cup are also available.

Mechanical Properties

Unbrako High Grade Alloy Steel
Hardness: Rc 45 Minimum

Notes

1. Corner of recess must have fillets to minimise stress concentrations.
2. Thread Class: 6g
3. Working Temperature: -50°C to +300°C
4. Angle: The cup angle is 135 max for screw lengths equal to or smaller than screw diameter. For longer lengths, the cup angle will be 124 max.
5. Torques calculated at 75% of the torsional shear strength of the respective Unbrako wrenches.

Maximum Tightening Torque

Thread size	Nm	lbf.in.
M3	0.87	7.7
M4	2.20	19.5
M5	4.60	41.0
M6	7.80	69.0
M8	18.00	160.0
M10	36.00	320.0
M12	62.00	550.0
(M14)	62.00	550.0
M16	150.00	1330.0
(M18)	290.00	2570.0
M20	290.00	2570.0
(M22)	475.00	4200.0
M24	475.00	4200.0

Length Tolerance

Screws Over	Up to and including	Tolerance
-	Screw Dia	+0.25 - 0.00
Screw Dia	50	±0.25
50	80	±0.50
80	120	±0.70
120	250	±0.80

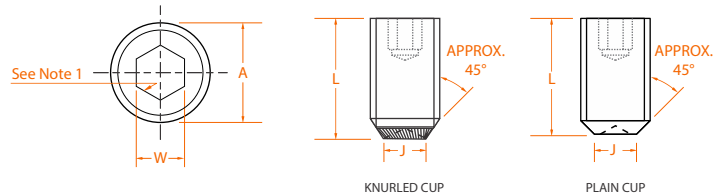

Product Dimensions

Thread size A nom.	Pitch	Hex Socket Size W nom.	Knurled Cup Point		Plain Cup Point	
			J max	L - min preferred	J max	L - min preferred
M2.5	0.45	1.27	-	-	1.2	3.0
M3	0.50	1.5	1.30	3.0	1.4	3.0
M4	0.70	2.0	2.10	3.0	2.0	3.0
M5	0.80	2.5	2.40	4.0	2.5	4.0
M6	1.00	3.0	3.30	5.0	3.0	4.0
M8	1.25	4.0	4.30	6.0	5.0	5.0
M10	1.50	5.0	5.25	8.0	6.0	6.0
M12	1.75	6.0	6.60	10.0	8.0	8.0
(M14)	2.00	6.0	8.10	12.0	9.0	10.0
M16	2.00	8.0	9.10	14.0	10.0	12.0
(M18)	2.50	10.0	10.30	16.0	12.0	14.0
M20	2.50	10.0	11.50	18.0	14.0	16.0
(M22)	2.50	12.0	12.65	20.0	16.0	18.0
M24	3.00	12.0	14.65	20.0	16.0	20.0

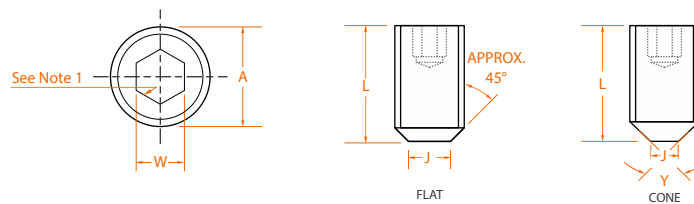

Thread size A nom.	Pitch	Hex Socket Size W nom.	Flat Point		Cone Point		$y^\circ \pm 2^\circ$ 90° for these Lengths & Over; and 120° Under
			J max.	L - min Preferred	J max.	L - min Preferred	
M3	0.50	1.5	2.0	3.0	Sharp	4.0	4.0
M4	0.70	2.0	2.5	3.0	Sharp	4.0	5.0
M5	0.80	2.5	3.5	4.0	Sharp	5.0	6.0
M6	1.00	3.0	4.0	4.0	1.5	6.0	8.0
M8	1.25	4.0	5.5	5.0	2.0	6.0	10.0
M10	1.50	5.0	7.0	6.0	2.5	8.0	12.0
M12	1.75	6.0	8.5	8.0	3.0	10.0	14.0
(M14)	2.00	6.0	10.0	10.0	4.0	12.0	14.0
M16	2.00	8.0	12.0	12.0	4.0	14.0	18.0
(M18)	2.50	10.0	13.0	12.0	5.0	16.0	20.0
M20	2.50	10.0	15.0	14.0	5.0	18.0	22.0
(M22)	2.50	12.0	17.0	16.0	6.0	20.0	28.0
M24	3.00	12.0	18.0	20.0	6.0	20.0	28.0

All Dimensions In Millimetres.
Sizes In Brackets Are Non-preferred Standards.

Socket Set Screws Full and Half Dog Point

Metric



Fasten collars, sheaves, gears, knobs on shafts. Locate machine parts. Self-locking knurled cup point is standard. Special Points like Flat, Dog, Cone & Plain Cup are also available.

Equivalent Standards

	BS 4168, ASME B18.3.6M
Flat Point	DIN 913, ISO 4026
Cone Point	DIN 914, ISO 4027
Dog Point	DIN 915, ISO 4028
Plain Cup	DIN 916, ISO 4028 ISO 898-5

Mechanical Properties

Unbrako High Grade Alloy Steel
Hardness: Rc 45 Minimum

Notes

1. Corner of recess must have fillets to minimise stress concentrations.
2. Thread Class: 6g
3. Working Temperature: -50°C to +300°C
4. Screws with lengths L or smaller will have half dog point H. Screws with lengths larger than L will have full dog point HL.
5. Torques calculated at 75% of the torsional shear strength of the respective Unbrako wrenches.

Length Tolerance

Screws Over	Up to and including	Tolerance
-	Screw Dia	+0.25 - 0.00
Screw Dia	50	±0.25
50	80	±0.50
80	120	±0.70
120	250	±0.80

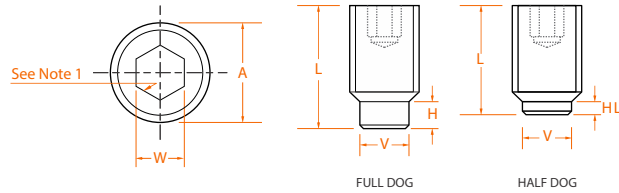

Product Dimensions

Thread size A nom.	Pitch	Hex Socket Size W nom.	Dog Point			
			L (See Note 4)	H-Full Dog max	HL-Half Dog max	V max
M3	0.50	1.5	5.00	1.75	1.00	2.00
M4	0.70	2.0	6.00	2.25	1.25	2.50
M5	0.80	2.5	6.00	2.75	1.50	3.50
M6	1.00	3.0	8.00	3.25	1.75	4.00
M8	1.25	4.0	10.00	4.30	2.25	5.50
M10	1.50	5.0	12.00	5.30	2.75	7.00
M12	1.75	6.0	16.00	6.30	3.25	8.50
(M14)	2.00	6.0	20.00	7.36	3.80	10.00
M16	2.00	8.0	20.00	8.36	4.30	12.00
(M18)	2.50	10.0	25.00	9.36	4.80	13.00
M20	2.50	10.0	25.00	10.36	5.30	15.00
(M22)	2.50	12.0	30.00	11.43	5.80	17.00
M24	3.00	12.0	30.00	12.43	6.30	18.00

Application Data

Thread size	Maximum Tightening Torque	
	Nm	lbf.in.
M3	0.87	7.7
M4	2.20	19.5
M5	4.60	41.0
M6	7.80	69.0
M8	18.00	160.0
M10	36.00	320.0
M12	62.00	550.0
(M14)	62.00	550.0
M16	150.00	1,330.0
(M18)	290.00	2,570.0
M20	290.00	2,570.0
(M22)	475.00	4,200.0
M24	475.00	4,200.0

Sizes in brackets are non-preferred standards.

Torsional and axial holding power

Tabulated axial and torsional holding powers are typical strengths and should be used accordingly, with specific safety factors appropriate to the given application and load conditions.

Thread Size	Seating Torque Nm	Axial Holding Power (kN)	Shaft diameter (shaft hardness Rc 15 to Rc 35) Torsional holding power Nm													
			1.4	1.6	1.8	2.0	3.0	4.0	5.0	6.0	8.0	10	12	14		
M1.4	.10	.19	.13	.15	.17	.19	.29	.38	.48							
M1.6	.10	.22	.15	.18	.20	.22	.33	.44	.55	.66						
M1.8	.10	.25	.18	.20	.23	.25	.38	.50	.63	.75	1.0					
M2.0	.21	.29	.20	.23	.26	.29	.44	.58	.73	.87	1.2	1.5				
M2.5	.60	.53		.42	.48	.53	.80	1.10	1.30	1.60	2.1	2.7	3.2			
M2.6	.60	.56			.50	.56	.84	1.10	1.40	1.70	2.2	2.8	3.4	3.9		
M3	.87	.71				.71	1.07	1.40	1.80	2.10	2.8	3.6	4.3	5.0		
M4	2.20	1.70				1.70	2.60	3.40	4.30	5.10	6.8	8.5	10.0	12.0		
M5	4.60	2.50					3.80	5.00	6.30	7.50	10.0	13.0	15.0	18.0		
M6	7.80	4.20							11.00	13.00	17.0	21.0	25.0	29.0		
M8	18.00	6.70								20.00	27.0	34.0	40.0	47.0		
M10	36.00	9.30									37.0	47.0	56.0	65.0		
M12	62.00	12.00										60.0	72.0	84.0		
M14	62.00	15.00											90.0	105.0		
M16	150.00	18.00												126.0		

Thread Size	Seating Torque Nm	Axial Holding Power (kN)	Shaft diameter (shaft hardness Rc 15 to Rc 35) Torsional holding power Nm													
			16	18	20	25	30	40	50	60	70	80	90	100		
M2.6	.60	.56	4.5													
M3	.87	.71	5.7	6.4	7.1											
M4	2.20	1.70	14.0	15.0	17.0	21										
M5	4.60	2.50	20.0	23.0	25.0	31	38									
M6	7.80	4.20	34.0	38.0	42.0	53	63	84								
M8	18.00	6.70	54.0	60.0	67.0	84	101	134	168	201						
M10	36.00	9.30	74.0	84.0	93.0	116	140	186	233	279						
M12	62.00	12.00	96.0	108.0	120.0	150	180	240	300	360	420					
M14	62.00	15.00	120.0	135.0	150.0	188	225	300	375	450	525	600				
M16	150.00	18.00	144.0	162.0	180.0	225	270	360	450	540	630	720	810			
M18	290.00	21.00	168.0	189.0	210.0	263	315	420	525	630	735	840	945	1050		
M20	290.00	23.00		207.0	230.0	288	345	460	575	690	805	920	1040	1150		
M22	475.00	26.00			260.0	325	390	520	650	780	910	1040	1170	1300		
M24	475.00	29.00				363	435	580	725	870	1020	1160	1310	1450		

Knurled Cup Point



Size	Part No.		lbs /1000
M3(0.5) - Key Size 1.5mm			
M3 x 3	104076	200	0.18
4	103172	200	0.24
5	103175	200	0.29
6	103176	200	0.40
8	103177	200	0.57
10	103178	200	0.73
12	103179	200	0.90
16	103180	200	1.30
M4 (0.7) - Key Size 2mm			
M4 x 4	103182	200	0.44
5	103185	200	0.55
6	103186	200	0.84
8	103187	200	1.01
10	103188	200	1.28
12	103189	200	1.56
15	401084	200	2.00
16	103191	200	2.13
20	103193	200	2.73
M5 (0.8) - Key Size 2.5mm			
M5 x 5	103194	200	0.88
6	103195	200	1.03
8	103196	200	1.54
10	103197	200	2.00
12	103198	200	2.46
15	401099	200	3.17
16	103199	200	3.39
20	103202	200	4.31
25	103203	200	5.48
30	103204	200	6.64
M6 (1) - Key Size 3mm			
M6 x 6	103207	200	1.41
8	103208	200	2.40
10	103209	200	2.73
12	103211	200	3.50
15	401087	200	4.36
16	103212	200	5.17
20	103214	200	6.01
25	103217	200	7.68
30	103218	200	9.33
35	103219	200	10.98
40	103220	200	12.65
45	103221	200	15.55
50	103222	200	15.95

Size	Part No.		lbs /1000
M8 (1.25) - Key Size 4mm			
M8 x 8	103224	200	3.92
10	103227	200	4.82
12	103228	200	6.23
15	401091	200	7.70
16	103229	200	8.43
20	103230	200	10.85
25	103231	200	13.86
30	103235	200	16.85
35	103236	200	19.87
40	103237	200	25.34
50	103240	200	28.91
M10 (1.5) - Key Size 5mm			
M10 x 10	103241	200	7.41
12	103244	200	9.04
15	401094	200	11.90
16	103245	200	12.85
20	103246	200	16.65
25	103247	200	21.41
30	103249	200	26.16
35	103251	200	34.54
40	103252	200	35.68
45	103253	100	40.44
50	103254	100	45.19
M12 (1.75) - Key Size 6mm			
M12 x 12	103256	100	12.25
16	103258	100	17.78
20	103259	100	23.32
25	103260	100	30.25
30	103261	100	37.16
35	103262	100	44.09
40	103263	50	51.00
45	103269	50	57.93
50	103270	50	64.83
60	103272	50	78.67
M16 (2) - Key Size 8mm			
M16 x 16	106352	50	30.40
20	103274	50	40.59
25	103276	50	53.33
30	103277	50	66.04
35	103278	50	78.78
40	103279	50	91.52
50	103282	50	116.97
55	103283	25	129.69
60	103284	25	142.43

Size	Part No.		lbs /1000
M20 (2.5) - Key Size 10mm			
M20 x 25	103286	50	79.64
30	103287	50	99.57
35	103288	25	119.53
40	103289	25	139.48
50	103292	25	179.37
60	103294	25	219.25

Flat Point



Size	Part No.		lbs /1000
M3 (0.5) - Key Size 1.5mm			
M3 x 3	120000	200	0.22
4	120001	200	0.22
5	104024	200	0.33
6	108106	200	0.44
8	108108	200	0.66
10	108109	200	0.66
12	104025	200	0.88
16	120004	200	1.32
M4 (0.7) - Key Size 2mm			
M4 x 4	121084	200	0.44
5	104027	200	0.59
6	111691	200	0.66
8	108110	200	0.88
10	104028	200	1.32
12	104029	200	1.76
16	108101	200	2.42
20	120005	200	2.64
M5 (0.8) - Key Size 2.5mm			
M5 x 5	121109	200	0.88
6	104031	200	1.10
8	104033	200	1.54
10	104034	200	2.20
12	104035	200	2.64
16	122408	200	3.74
20	104038	200	4.62
25	120006	200	5.94
M6 (1) - Key Size 3mm			
M6 x 6	105476	200	1.54
8	108095	200	2.20
10	108111	200	2.86
12	122395	200	3.74



Pieces per Box

Property Class: 45H

Flat Point



Dog Point



Size	Part No.		lbs /1000
M6 (1) - Key Size 3mm			
M6 x 15	401089	200	4.84
16	104041	200	5.28
20	108096	200	6.82
25	104042	200	8.80
30	104043	200	10.56
40	120009	200	14.52

M8 (1.25) - Key Size 4mm			
M8 x 8	120861	200	3.74
10	108227	200	4.40
12	104044	200	6.93
16	120012	200	8.43
20	120013	200	13.64
25	106340	200	14.96
30	120014	200	16.85
35	120016	200	28.60
40	120017	200	25.34
50	120020	200	29.72

M10 (1.5) - Key Size 5mm			
M10 X 10	107993	200	6.38
12	108257	200	7.92
16	110881	200	14.30
20	110897	200	17.14
25	120022	200	23.76
30	120023	200	28.60
40	120025	200	39.82
50	120027	100	48.40

M12 (1.75) - Key Size 6mm			
M12 X 12	120028	100	13.86
16	120029	100	19.80
20	107985	100	26.18
25	125795	100	35.20
40	120032	50	55.88
50	120033	50	70.62
60	120037	50	83.60

Size	Part No.		lbs /1000
M3 (0.5) - Key Size 1.5mm			
M3 x 5*	120182	200	0.22
6	120185	200	0.44
8	108149	200	0.66
10	120188	200	0.66

M4 (0.7) - Key Size 2mm			
M4 x 5*	120194	200	0.55
6*	120195	200	0.66
8	120197	200	0.88
10	108226	200	1.32
12	120199	200	1.76
20	120204	200	2.64

M5 (0.8) - Key Size 2.5mm			
M5 x 6*	120209	200	1.10
8	120210	200	1.54
10	108151	200	2.20
12	120211	200	2.64
16	120212	200	3.74

M6 (1) - Key Size 3mm			
M6 x 8*	120216	200	2.20
10	122149	200	2.86
12	108112	200	3.74
16	108099	200	5.28
20	108034	200	6.82
25	108159	200	8.80
30	107988	200	10.56

M8 (1.25) - Key Size 4mm			
M8 x 8*	120222	200	3.74
10	107983	200	4.40
12	120226	200	5.06
16	120227	200	9.02
20	121121	200	13.64
25	120228	200	14.96
30	108188	200	24.20
40	108146	200	33.00

Size	Part No.		lbs /1000
------	----------	--	-----------

M10 (1.5) - Key Size 5mm			
M10 x 10*	108207	200	6.38
16	108191	200	14.30
20	108113	200	18.48
25	108085	200	23.76
30	108098	200	34.98
45	120238	100	44.22
50	120240	100	48.62

M12 (1.75) - Key Size 6mm			
M12 x 12*	120242	100	14.30
20	120243	100	26.18
25	120244	100	33.66
40	107982	50	55.88
50	120248	50	70.62

M16 (2) - Key Size 8mm			
M16 x 30	107984	50	65.78
40	108039	50	94.38
50	120259	50	122.76
60	120261	25	151.14

M20 (2.5) - Key Size 10mm			
M20 x 50	120270	25	210.10
60	120275	25	242.95

Cone Point



Size	Part No.		lbs /1000
------	----------	--	-----------

M3 (0.5) - Key Size 1.5mm			
M3 x 5	120071	200	0.31
6	108208	200	0.44
8	120072	200	0.66

M4 (0.7) - Key Size 2mm			
M4 x 5	120076	200	0.55
6	108143	200	0.66
8	108249	200	0.88
10	120077	200	1.32
12	120078	200	1.76



Pieces per Box

Property Class: 45H

* Half dog point as standard

Cone Point



Size	Part No.		lbs /1000
------	----------	--	-----------

M5 (0.8) - Key Size 2.5mm

M5 x 6	120085	200	1.10
8	120086	200	1.54
10	113532	200	2.20
12	108144	200	2.64
16	120088	200	3.74

M6 (1) - Key Size 3mm

M6 x 6	108209	200	1.32
8	108041	200	1.87
10	108210	200	2.86
12	108081	200	3.74
16	108224	200	5.28
20	108020	200	6.82
25	108158	200	8.80
30	120093	200	10.56

M8 (1.25) - Key Size 4mm

M8 x 8	108097	200	3.74
10	120102	200	4.40
12	120103	200	5.06
16	120104	200	9.02
20	120105	200	13.64
25	120106	200	14.96

M10 (1.5) - Key Size 5mm

M10 x 12	120115	200	7.92
16	108211	200	13.64
20	120116	200	17.60
25	120916	200	23.76
40	403341	200	39.82

M12 (1.75) - Key Size 6mm

M12 x 16	120129	100	19.80
20	120130	100	26.18

Plain Point



Size	Part No.		lbs /1000
------	----------	--	-----------

M2.5 (0.45) - Key Size 1.27mm

M2.5 x 3	104173	200	0.13
6	104115	200	0.31
8	104116	200	0.42
10	104117	200	0.53

M3 (0.5) - Key Size 1.5mm

M3 x 3	120917	200	0.18
4	104045	200	0.26
5	104048	200	0.31
6	104050	200	0.42

M4 (0.7) - Key Size 2mm

M4 x 4	104051	200	0.44
5	104052	200	0.59
6	104053	200	0.75
8	104054	200	1.03

M5 (0.8) - Key Size 2.5mm

M5 x 5	104057	200	0.86
6	104058	200	1.10
10	104060	200	2.05
12	107871	200	2.53

M6 (1) - Key Size 3mm

M6 x 6	104061	200	1.67
8	114523	200	2.13
10	105882	200	2.82
12	104064	200	3.50
16	108121	200	4.86
25	108122	200	7.96

M8 (1.25) - Key Size 4mm

M8 x 8	116965	200	3.76
10	119229	200	4.99
12	117455	200	6.23

Size	Part No.		lbs /1000
------	----------	--	-----------

M10 (1.5) - Key Size 5mm

M10 x 16	104073	200	13.24
20	104074	200	17.14
25	122205	200	22.02

M12 (1.75) - Key Size 6mm

M12 x 12	108056	100	12.61
20	108053	100	23.89



Pieces per Box

Property Class: 45H

Socket Set Screws #0 to #10

Inch



Fasten collars, sheaves, gears, knobs on shafts. Locate machine parts. Self-locking knurled cup point is standard. Special Points like Flat, Dog, Cone & Plain Cup are also available.

Equivalent Standards

ASME B18.3, BS 2470

Mechanical Properties

Material : ASTM F912

Dimensions : ASME/ANSI B18.3

Hardness : Rc 45-53

Thread : 3A

Length Tolerance

Diameter	.63 and under	over .63 to 2"	over 2" to 6"	over 6"
	All	±.01	±.02	±.03

NOTE

1. Knurled Cup Point: When length equals nominal dia or less, included angle is 130°.
2. Cone Cup Point: When length equals nominal diameter or less, included angle is 118°. (#4 x 1/8 and #8 x 3/16 also have 118° angle)

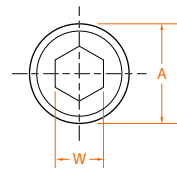
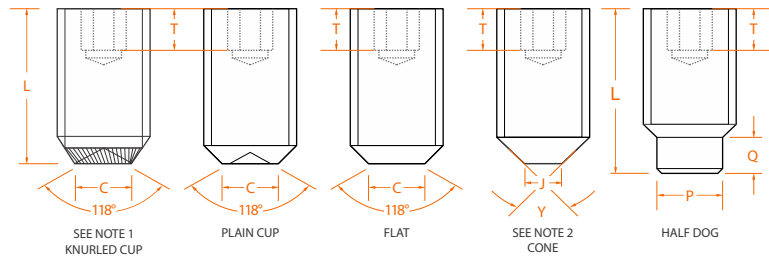

Product Dimensions

nom. size	Threads per inch.		Head Diameter A			Hex Socket Size W C		
	UNRC	UNRF	max	UNRC	UNRF	nom	max	min
#0	-	80	.0600	-	.0568	.028	.033	.027
#1	64	72	.0730	.0692	.0695	.035	.040	.033
#2	56	64	.0860	.0819	.0822	.035	.047	.039
#3	48	56	.0990	.0945	.0949	.050	.054	.045
#4	40	48	.1120	.1069	.1075	.050	.061	.051
#5	40	44	.1250	.1199	.1202	.0625	.067	.057
#6	32	40	.1380	.1320	.1329	.0625	.074	.064
#8	32	36	.1640	.1580	.1585	.0781	.087	.076
#10	24	32	.1900	.1825	.1840	.0937	.102	.088

nom. size	Q		T*	P		Recommended** seating torque In-lbs	screw length nom.
	max	min	min	max	min		
#0	.017	.013	.035	.040	.037	1.0	3/32
#1	.021	.017	.035	.049	.045	1.8	1/8
#2	.024	.020	.035	.057	.053	1.8	1/8
#3	.027	.023	.060	.066	.062	5	5/32
#4	.030	.026	.075	.075	.070	5	5/32
#5	.033	.027	.075	.083	.078	10	5/32
#6	.038	.032	.075	.092	.087	10	3/16
#8	.043	.037	.075	.109	.103	20	3/16
#10	.049	.041	.105	.127	.120	36	3/16

*CAUTION: Values shown in column T are for minimum stock length cup point screws. Screws shorter than nominal minimum length shown do not have sockets deep enough to utilize full key capability which can result in failure of socket, key or mating threads.

**Torque application only to minimum, nominal lengths shown or longer.

Socket Set Screws

1/4 to 1 1/2

Inch



Fasten collars, sheaves, gears, knobs on shafts. Locate machine parts. Self-locking knurled cup point is standard. Special Points like Flat, Dog, Cone & Plain Cup are also available.

Equivalent Standards

ASME B18.3, BS 2470

Mechanical Properties

Material : ASTM F912 – alloy steel

Dimensions : ASME/ANSI B18.3

Hardness : Rc 45-53 (alloy steel only),

Thread : 3A

Length Tolerance

Diameter	.63 and under	over .63 to 2"	over 2" to 6"	over 6"
All	±.01	±.02	±.03	±.06

NOTE

1. Cone Cup Point: When length equals nominal diameter or less, included angle is 118°. (#4 x 1/8 and #8 x 3/16 also have 118° angle)

2. Knurled Cup Point: When length equals nominal dia or less, included angle is 130°.

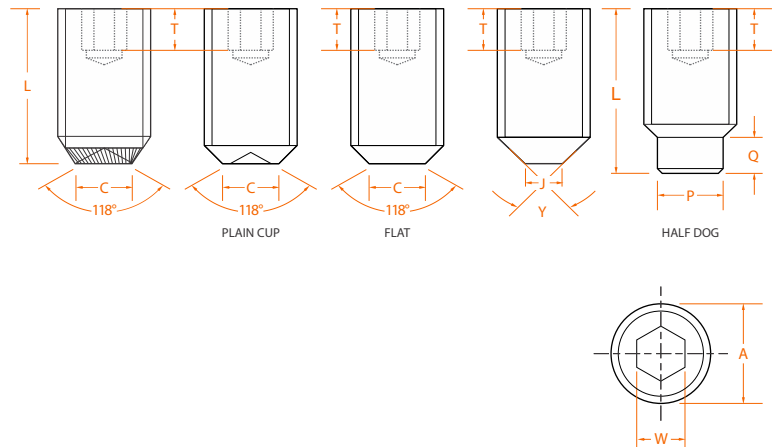

Product Dimensions

nom. size	Thread per inch.		Head Diameter A			Hex Socket Size		
	UNRC	UNRF	max	UNRC	UNRF	W nom	C max min	
1/4	20	28	.2500	.2419	.2435	.125	.132	.118
5/16	18	24	.3125	.3038	.3053	.1562	.172	.156
3/8	16	24	.3750	.3656	.3678	.1875	.212	.194
7/16	14	20	.4375	.4272	.4294	.2187	.252	.232
1/2	13	20	.5000	.4891	.4919	.250	.291	.270
9/16	12	18	.5625	.5511	.5538	.250	.332	.309
5/8	11	18	.6250	.6129	.6163	.3125	.371	.347
3/4	10	16	.7500	.7371	.7406	.375	.450	.425
7/8	9	14	.8750	.8611	.8647	.500	.530	.502
1	8	12	1.0000	.9850	.9886	.5625	.609	.579
1 1/8	7	12	1.1250	1.1086	1.1136	.5625	.689	.655
1 1/4	7	12	1.2500	1.2336	1.2386	.625	.767	.733
1 3/8	6	12	1.3750	1.3568	1.3636	.625	.848	.808
1 1/2	6	12	1.5000	1.4818	1.4886	.750	.926	.886

nom. size	Q		T*	P		Recommended ** seating torque In-lbs	screw length nom.
	max	min	min	max	min		
1/4	.067	.059	.105	.156	.149	87	5/16
5/16	.082	.074	.140	.203	.195	165	3/8
3/8	.099	.089	.140	.250	.241	290	7/16
7/16	.114	.104	.190	.297	.287	430	1/2
1/2	.130	.120	.210	.344	.334	620	9/16
9/16	.146	.136	.265	.390	.379	620	5/8
5/8	.164	.148	.265	.469	.456	1,325	11/16
3/4	.196	.180	.330	.562	.549	2,400	3/4
7/8	.227	.211	.450	.656	.642	3,600	3/4
1	.260	.240	.550	.750	.734	5,000	7/8
1 1/8	.291	.271	.650	.844	.826	7,200	1
1 1/4	.323	.303	.700	.938	.920	9,600	1 1/8
1 3/8	.354	.334	.700	1.031	1.011	9,600	1 1/4
1 1/2	.385	.365	.750	1.125	1.105	11,320	1 1/4

*CAUTION: Values shown in column T are for minimum stock length cup point screws. Screws shorter than nominal minimum length shown do not have sockets deep enough to utilize full key capability which can result in failure of socket, key or mating threads.

**Torque application only to minimum, nominal lengths shown or longer.



Torsional and axial holding power

(Based on Recommended Seating Torques – Inch-Lbs.)

Tabulated axial and torsional holding powers are typical strengths and should be used accordingly, with specific safety factors appropriate to the given application and load conditions.

Thread Size	Seating Torque lbf.in.	Axial Holding Power (lbf)	Shaft diameter (shaft hardness Rc 15 to Rc 35) Torsional Holding Power lbf.in.												
			1/16	3/32	1/8	5/32	3/16	7/32	1/4	5/16	3/8	7/16	1/2	9/16	
#0	1.0	50	1.5	2.3	3.1	3.9	4.7	5.4	6.2						
#1	1.8	65	2.0	3.0	4.0	5.0	6.1	7.1	8.1	10.0					
#2	1.8	85	2.6	4.0	5.3	6.6	8.0	9.3	10.6	13.2	16.0				
#3	5.0	120	3.2	5.6	7.5	9.3	11.3	13.0	15.0	18.7	22.5	26.3			
#4	5.0	160		7.5	10.0	12.5	15.0	17.5	20.0	25.0	30.0	35.0	40.0		
#5	10.0	200			12.5	15.6	18.7	21.8	25.0	31.2	37.5	43.7	50.0	56.2	
#6	10.0	250				19.0	23.0	27.0	31.0	39.0	47.0	55.0	62.0	70.0	
#8	20.0	385				30.0	36.0	42.0	48.0	60.0	72.0	84.0	96.0	108.0	
#10	36.0	540					51.0	59.0	68.0	84.0	101.0	118.0	135.0	152.0	
1/4	87.0	1,000							125.0	156.0	187.0	218.0	250.0	281.0	
5/16	165.0	1,500								234.0	280.0	327.0	375.0	421.0	
3/8	290.0	2,000									375.0	437.0	500.0	562.0	
7/16	430.0	2,500										545.0	625.0	702.0	
1/2	620.0	3,000											750.0	843.0	
9/16	620.0	3,500												985.0	

Thread Size	Seating Torque lbf.in.	Axial Holding Power (lbf)	Shaft diameter (shaft hardness Rc 15 to Rc 35) Torsional Holding Power lbf.in.											
			5/8	3/4	7/8	1	1 1/4	1 1/2	1 3/4	2	2 1/2	3	3 1/2	4
#5	10.0	200	62											
#6	10.0	250	78	94	109									
#8	20.0	385	120	144	168	192								
#10	36.0	540	169	202	236	270	338							
1/4	87.0	1,000	312	375	437	500	625	750						
5/16	165.0	1,500	468	562	656	750	937	1125	1310	1500				
3/8	290.0	2,000	625	750	875	1000	1250	1500	1750	2000				
7/16	430.0	2,500	780	937	1095	1250	1560	1875	2210	2500	3125			
1/2	620.0	3,000	937	1125	1310	1500	1875	2250	2620	3000	3750	4500		
9/16	620.0	3,500	1090	1310	1530	1750	2190	2620	3030	3500	4370	5250	6120	
5/8	1,325.0	4,000	1250	1500	1750	2000	2500	3000	3750	4000	5000	6000	7000	8000
3/4	2,400.0	5,000		1875	2190	2500	3125	3750	4500	5000	6250	7500	8750	10000
7/8	5,200.0	6,000			2620	3000	3750	4500	5250	6000	7500	9000	10500	12000
1	7,200.0	7,000				3500	4375	5250	6120	7000	8750	10500	12250	14000

Socket Set Screws - Inch

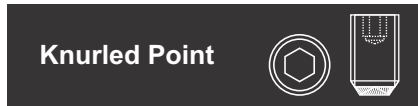

Size	Part No.		lbs /1000
#4-40 UNC - Key Size 0.05"			
#4 x 1/8	107218	100	0.18
3/16	107235	100	0.29
1/4	117866	100	0.40
1/2	117933	100	0.81
#4-48 UNF - Key Size 0.05"			
#4 x 1/8	107829	100	0.18
3/16	107846	100	0.31
3/8	107894	100	0.64
#5-40 UNC - Key Size 1/16"			
#5 x 1/8	117965	100	0.22
3/16	117981	100	0.33
1/4	117997	100	0.48
1/2	118063	100	1.03
5/8	114014	100	1.32
#5-44 UNF - Key Size 1/16"			
#5 x 1/8	107912	100	0.20
#6-32 UNC - Key Size 1/16"			
#6 x 1/8	102949	100	0.24
3/16	102967	100	0.42
1/4	102983	100	0.57
5/16	108396	100	0.75
3/8	121651	100	0.90
7/16	102767	100	1.17
1/2	121751	100	1.23
3/4	102866	100	1.89
7/8	115033	100	2.22
#8-32 UNC - Key Size 5/64"			
#8 x 1/8	113100	100	0.33
3/16	105233	100	0.57
1/4	114173	100	0.81
5/16	102972	100	1.06
3/8	103005	100	1.32
1/2	103071	100	1.80
5/8	108566	100	2.29
3/4	113228	100	2.79
1	111282	100	3.76
#8-36 UNF - Key Size 5/64"			
#8 x 1/8	119355	100	0.35

Size	Part No.		lbs /1000
#10-24 UNC - Key Size 3/32"			
#10 x 3/16	105845	100	0.70
1/4	105877	100	1.01
5/16	105909	100	1.34
3/8	116953	100	1.67
7/16	116987	100	2.16
1/2	117019	100	2.27
5/8	117053	100	2.93
3/4	117085	100	3.54
7/8	119137	100	4.18
1	119170	100	4.80
#10-32 UNF - Key Size 3/32"			
#10 x 3/16	119453	100	0.84
1/4	119470	100	1.19
5/16	119486	100	1.47
3/8	119502	100	1.80
1/2	119535	100	2.51
5/8	105919	100	3.19
3/4	109095	100	3.87
1	109112	100	5.26
1-1/4	109129	100	7.04
1/4-20 UNC - Key Size 1/8"			
1/4 x 3/16	114668	100	1.17
1/4	114700	100	1.52
5/16	114733	100	2.68
3/8	114766	100	3.39
7/16	119197	100	3.43
1/2	120250	100	3.98
5/8	119902	100	5.13
3/4	119934	100	6.25
7/8	113809	100	7.39
1	113841	100	8.51
1-1/4	113874	100	10.78
1-1/2	103000	100	14.45
2	103032	100	19.10
1/4-28 UNF - Key Size 1/8"			
1/4 x 3/16	120550	100	1.32
1/4	120568	100	1.61
5/16	120584	100	2.35
3/8	120600	100	3.17
7/16	120616	100	3.43
1/2	120632	100	4.40
5/8	120648	100	5.63
3/4	120665	100	6.86
1	120681	100	9.35

Size	Part No.		lbs /1000
5/16-18 UNC - Key Size 5/32"			
5/16" x 1/4	104901	100	2.68
5/16	104917	100	3.59
3/8	104934	100	4.51
7/16	104950	100	5.43
1/2	104966	100	7.28
5/8	104982	100	8.18
3/4	104998	100	10.01
1	105030	100	13.68
1 1/4	118995	100	17.36
1 1/2	119011	100	21.01
2	119043	100	28.36
5/16-24 UNF - Key Size 5/32"			
5/16"x1/4	118675	100	2.93
5/16	118691	100	3.92
3/8	118707	100	4.91
7/16	118723	100	5.87
1/2	118739	100	6.49
5/8	118755	100	8.82
3/4	118773	100	10.78
1	120327	100	13.64
3/8-16 UNC - Key Size 3/16"			
3/8" x 1/4	112027	100	3.65
5/16	112043	100	4.99
3/8	112059	100	6.36
1/2	112092	100	10.58
5/8	112108	100	11.77
3/4	112124	100	14.48
1	112157	100	19.87
1-1/4	112173	100	25.28
1-1/2	112189	100	30.69
1-3/4	112206	100	36.10
2	112221	100	41.51
2-1/2	112237	100	52.32
3/8-24 UNF - Key Size 3/16"			
3/8" x 5/16	120377	100	5.52
3/8	120393	100	7.00
1/2	120412	100	9.92
5/8	120420	100	12.85
3/4	120428	100	15.75
1	120436	100	21.60
1-1/4	120444	100	27.43
1-1/2	120452	100	33.29

Pieces per Box

HIGH-GRADE ALLOY STEEL

Knurled Point



Size	Part No.		lbs /1000
7/16-14 UNC - Key Size 7/32"			
7/16" x 1/2	112285	100	12.06
3/4	112319	100	19.43
1	108800	100	26.82
7/16-20 UNF - Key Size 7/32"			
7/16" x 3/8	120460	100	9.17
7/16	117092	100	11.13
1/2-13 UNC - Key Size 1/4"			
1/2" x 3/8	108901	100	10.56
1/2	119072	100	15.47
5/8	119088	100	20.35
3/4	119104	100	25.23
1	108300	100	35.00
1-1/4	108316	100	44.77
1-1/2	116557	100	54.54
2	102333	100	74.10
1/2-20 UNF - Key Size 1/4"			
1/2" x 1/2	119207	100	17.07
3/4	119239	100	27.63
1	119256	100	38.21
5/8-11 UNC - Key Size 5/16"			
5/8" x 1/2	111417	100	22.57
5/8	111449	50	30.34
7/8	117842	50	45.89
1	117875	50	53.68
1-1/4	117909	25	69.23
1-1/2	111467	25	84.79
1-3/4	111499	25	100.32
5/8-18 UNF - Key Size 5/16"			
5/8" x 5/8	119273	50	33.51
1	119289	50	58.72

Plain Point



Size	Part No.		lbs /1000
#0-80 UNF - Key Size 0.028"			
#0 x 1/16	114082	100	0.02
3/32	114099	100	0.04
1/8	114116	100	0.07
3/16	114148	100	0.09
1/4	107259	100	0.11
#1-64 UNF - Key Size 0.035"			
#1 x 1/16	107275	100	0.04
3/32	119983	100	0.06
1/8	118176	100	0.08
#2-56 UNC - Key Size 0.035"			
#2 x 1/16	106816	100	0.06
3/32	113649	100	0.09
1/8	113665	100	0.11
3/16	113698	100	0.18
1/4	113714	100	0.24
#3-48 UNC - Key Size 0.050"			
#3 x 3/32	113730	100	0.09
1/8	113747	100	0.11
3/16	102978	100	0.26
1/4	102995	100	0.37
#4-40 UNC - Key Size 0.050"			
#4 x 1/8	103011	100	0.18
3/16	103027	100	0.29
1/4	103043	100	0.40
5/16	103061	100	0.51
3/8	103078	100	0.62
1/2	108572	100	0.84
5/8	108589	100	1.08
#4-48 UNF - Key Size 0.050"			
#4 x 1/8	118241	100	0.20
#5-40 UNC - Key Size 1/16"			
#5 x 1/8	108607	100	0.24
3/16	108623	100	0.37
1/4	108640	100	0.53
5/16	108658	100	0.70
3/8	108674	100	0.81
1/2	108707	100	1.03

Size	Part No.		lbs /1000
#6-32 UNC - Key Size 1/16"			
#6 x 1/8	113057	100	0.24
3/16	113073	100	0.42
1/4	109399	100	0.59
5/16	109417	100	0.75
3/8	109433	100	0.92
1/2	109465	100	1.25
5/8	109481	100	1.58
3/4	109498	100	1.94
1	109531	100	2.60
#6-40 UNF - Key Size 1/16"			
#6 x 1/8	119216	100	0.26
3/16	119232	100	0.46
1/4	119249	100	0.64
3/8	119282	100	0.99
#8-32 UNC - Key Size 5/64"			
#8 x 1/8	114993	100	0.33
3/16	115009	100	0.59
1/4	108241	100	0.84
5/16	108256	100	1.10
3/8	108273	100	1.34
1/2	118841	100	1.85
5/8	118857	100	2.33
3/4	118873	100	2.84
1	118905	100	3.85
#10-24 UNC - Key Size 3/32"			
#10 x 3/16	118921	100	0.73
1/4	118937	100	1.03
5/16	118953	100	1.36
3/8	118970	100	1.67
1/2	111770	100	2.33
#10-32 UNF - Key Size 3/32"			
#10 x 3/16	119397	100	0.84
1/4	119413	100	1.19
5/16	119429	100	1.50
3/8	120397	100	1.85
1/2	107300	100	2.55
5/8	107316	100	3.26
3/4	107332	100	3.94
1	117212	100	5.35
1 1/4	117228	100	6.73
1/4-20 UNC - Key Size 1/8"			
1/4" x 1/4	106510	100	1.78
5/16	113489	100	2.38



Socket Set Screws - Inch Plain Point



Size	Part No.		lbs /1000
1/4-20 UNC - Key Size 1/8"			
1/4" x 3/8	113554	100	3.39
1/2	106569	100	4.11
5/8	119558	100	5.28
3/4	117296	100	6.42
1	117427	100	8.76
1 1/4	117492	100	11.07
1 1/2	112469	100	13.40
1 3/4	103102	100	15.71
2	103135	100	18.04
#1/4-28 UNF - Key Size 1/8"			
1/4" x 1/4	117260	100	1.94
5/16	117277	100	2.66
3/8	117293	100	3.26
1/2	107183	100	4.51
5/8	107199	100	5.79
3/4	116503	100	7.04
1	104560	100	9.57
1 1/4	104592	100	12.08
#5/16-18 UNC - Key Size 5/32"			
5/16" x 1/4	103169	100	2.77
5/16	103201	100	3.70
3/8	112503	100	4.64
1/2	112568	100	6.51
5/8	103243	100	8.38
3/4	105227	100	10.25
1	113079	100	14.01
1 1/4	109423	100	17.75
1 1/2	109455	100	21.49
1 3/4	109487	100	25.26
2	109521	100	30.98
#5/16-24 UNF - Key Size 5/32"			
5/16" x 1/4	104624	100	3.01
5/16	104657	100	4.00
3/8	104689	100	5.02
1/2	104753	100	7.02
5/8	104785	100	8.25
3/4	110243	100	11.00
1	115929	100	15.00
#3/8-16 UNC - Key Size 3/16"			
3/8" x 1/4	114999	100	4.38
5/16	108247	100	4.99
3/8	118815	100	6.40
1/2	118879	100	9.13
5/8	118911	100	11.86

Size	Part No.		lbs /1000
#3/8-16 UNC - Key Size 3/16"			
3/8" x 3/4	118943	100	14.56
7/8	117817	100	17.29
1	112019	100	20.02
1 1/4	113565	100	26.84
1 1/2	113597	100	33.88
1 3/4	113630	100	36.34
2	106548	100	41.80
3/8-24 UNF - Key Size 3/16"			
3/8" x 1/4	115994	100	4.66
5/16	116026	100	5.65
3/8	115083	100	7.15
1/2	115149	100	10.60
5/8	115181	100	13.09
3/4	114813	100	16.06
1	114845	100	22.00
1 1/4	114880	100	27.94
1 1/2	114912	100	33.88
7/16-14 UNC - Key Size 7/32"			
7/16" x 3/8	114169	100	8.80
1/2	103001	100	12.28
3/4	103067	100	19.80
1	108595	100	27.30
7/16-20 UNF - Key Size 7/32"			
7/16" x 3/8	103568	100	9.35
1/2	103602	100	13.38
1/2-13 UNC - Key Size 1/4"			
1/2" x 3/8	114340	100	10.82
1/2	108519	100	15.77
5/8	108535	100	20.75
3/4	102895	100	25.72
7/8	102911	100	30.69
1	104078	100	35.66
1 1/4	104095	100	45.58
1 1/2	104112	100	55.53
1 3/4	104128	50	65.45
2	104144	50	75.39
2 1/2	104160	50	95.26
1/2-20 UNF - Key Size 1/4"			
1/2" x 1/2	103619	100	17.36
5/8	103635	100	22.73
3/4	115447	100	28.07
1	115463	100	38.81

Size	Part No.		lbs /1000
5/8-11 UNC - Key Size 5/16"			
5/8" x 1/2	109923	100	22.57
5/8	109939	50	30.34
3/4	109957	50	38.13
1	109990	50	53.68
1 1/4	110006	25	69.23
1 1/2	110022	25	84.79
1 3/4	110038	25	100.32
2	110055	25	115.87
5/8-18 UNF - Key Size 5/16"			
5/8" x 5/8	115480	50	33.59
1	115497	50	58.85

TAPER PRESSURE PLUGS

Dryseal Type With 3/4-inch Taper per Foot

- Dryseal-thread form achieves a seal without need for compound
- Heat treated alloy steel for strength
- Roundness-closely controlled for better sealing
- Uniform taper of 3/4 inch per foot

Precision hex socket with maximum depth for positive wrenching at higher seating torques

Controlled chamfer for faster starting



LEVL SEAL® TYPE Dryseal Thread Form with 7/8-inch per foot

Precision hex socket with maximum depth for positive wrenching at higher seating torques

Heat treated alloy steel for strength Rounded closely controlled for better sealing

High pressure is developed through a deliberate difference of taper between the plug and the tapped hole having standard 3/4" taper

Flush seating is achieved through closer control of thread forms, sizes and taper-improves safety and appearance Fully formed PTF dryseal threads for better sealing without the use of a compound

Controlled chamfer for faster starting

Pressure plugs are not pipe plugs. Pipe plugs (plumber's fittings) are limited to pressures of 600 psi, are sealed with a compound, and are made of cast iron with cut threads and protruding square drive.

Pressure plugs are made to closer tolerances, are generally of higher quality, and almost all have taper threads. Properly made and used, they will seal at pressures to 5000 psi and without a sealing compound (pressure tests are usually at 20,000 psi.) they are often used in hydraulic and pneumatic designs.

Performance Requirements

Pressure plugs used in industrial applications should:

- not leak at pressures to 5000 psi
- need no sealing compounds
- be reusable without seizure
- give a good seal when reused
- seal low viscosity fluids
- require minimum seating torque
- require minimum re-tooling or special tools.

For a satisfactory seal, the threads of the plug and those in the mating hole must not gall or seize up to maximum possible tightening

torque. Galling and seizure are caused by metal pickup on the mating surfaces and are directly related to force on the surface, material hardness, lubrication used, and thread finish.

How Pressure Plugs Seal

Sealing is achieved by crushing the crest of one thread against the root of the mating thread. If too much of compressive force is required to torque the plug, it will tend to gall in the hole. Too little force will not deform the crest of threads enough to produce a seal. Increasing the hardness of the material will reduce galling but will also increase the required sealing force. Generally a hardness range of Rc 30 to 40 will meet most requirements. The tightening force must be low enough to cause no galling in this range.

Cost Considerations

Dryseal plugs are more frequently used, especially where reuse is frequent. Reason: more threads are engaged and they therefore resist leakage better. They are also preferred in soft metals to reduce of over-torquing.

TYPES OF PRESSURE PLUG THREADS

Three thread forms are commonly used for pipe plugs and pressure plugs:

NPT: National Pipe thread, Tapered. This is the thread form commonly used for commercial pipe and fittings for low pressure applications. A lubricant and sealer are generally used.

ANPT: Aeronautical National Pipe thread, Tapered. Covered by MIL-S-7105, this thread form was developed for aircraft use. It is basically the same as the NPT thread except that tolerances have been reduced about 50 percent. Plugs made with this thread should be used with lubricants and sealers. They are not to be used for hydraulic applications.

NPTF: National Pipe thread, Tapered, Fuel. This is the standard thread for pressure plugs. They make pressure-tight joints without a sealant. Tolerances are about 1/4 those for NPT threads. The standard which applies is ANSI B1.20.3. Applicable for fluid power applications.

TAPER PRESSURE PLUGS

Deliberate difference in taper between the plug and the tapped hole. Ideal for use in assemblies where clearance is limited and in hydraulic lines near moving parts. Designed for use in hard materials and in thick-walled sections as well as for normal plug applications.

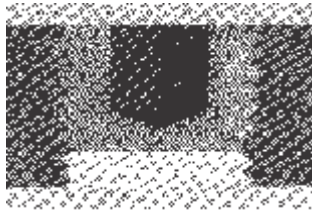

High pressure seal— Achieved through metal-to-metal contact at the large end of the plug. High load placed on the few mating threads near the top of the hole.



Flush seating—Design of LEVL-SEAL plug permits seating within half a pitch in a normally tapped hole. Conventional plugs have the greater tolerance of a full pitch and usually protrude above the surface.

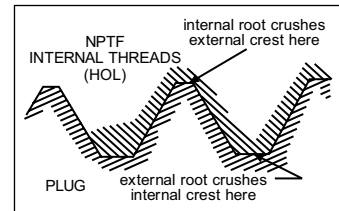

PTF fully formed Dryseal threads designed to achieve seal in tapped holes without need for sealing compounds.

PTFE/TEFLON Coated LEVL-SEAL Type

Typical thickness is 0.0005-inch LEVL-SEAL precision coated with tough, corrosion-resistant PTFE/TEFLON.

Installation of the new plugs is faster with the coating of PTFE/TEFLON which acts as a lubricant as well as seal. Power equipment can be used to install the smaller sizes instead of the manual wrenching required by higher torques of un-coated plugs. Suited for in assembly line production.

Higher hydraulic and pneumatic working pressures can be effectively sealed. Seal is effective without use

of tapes or sealing compounds, even with liquids of very low viscosity. Unbrako Laboratories have tested these plugs with surges up to 13,500 psi 8 times in 5 minutes, then held peak pressure for 6 full hours without trace of leakage.

Flush seating improves appearance and adds safety. LEVL-SEAL plugs seat flush because of a combination of (1) gaging procedures, and (2) a deliberate difference in taper between the plug and a normally tapped NPTF hole. (The taper of the plug is 7/8" per foot, while that of the hole is 3/4" per foot.)

PTFE/TEFLON was selected for the coating material because of its

combination of extra hardness and abrasion resistance which permit reuse up to 5 times without appreciable loss of seal.

The coating is serviceable to +450°F without deterioration.

Temperatures lower than -100°F require the use of stainless steel plugs. These are available in the same range of sizes as the alloy steel plugs.

With no tape or sealing compound involved, there is no danger of foreign matter entering and contaminating the system or equipment. The coating reduces any tendency of the plug to "freeze" in the hole because of rust or corrosion.



Taper Pressure Plugs DIN 906

Metric



Precision thread for positive seal without sealing compound; controlled chamfer for faster starting.

Mechanical Properties

Thread shall conform to DIN 158
Heat Treatment: 35-40 HRC

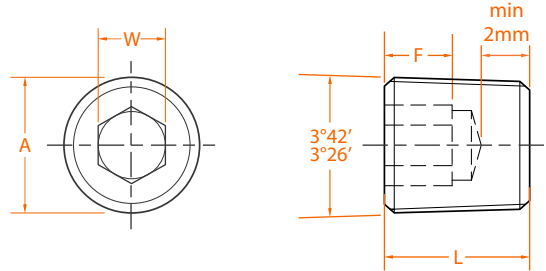

Product Dimensions

Nom Dia	Pitch	Head Diameter A		Hex Socket Size W		Length L		Socket Depth F	Socket Drill Size
		max	min	max	min	max	min	min	
M8	1	6.66	6.41	4.07	4.02	8.25	7.75	4.00	4.14
M10	1	8.66	8.41	5.08	5.02	8.25	7.75	4.00	5.15
M12	1.5	10.09	9.84	6.09	6.02	10.25	9.75	5.00	6.17
M14	1.5	12.09	11.84	7.11	7.03	10.25	9.75	5.00	7.20
M16	1.5	14.09	13.84	8.11	8.03	10.25	9.75	5.00	8.20
M18	1.5	16.09	15.84	8.11	8.03	10.25	9.75	5.00	8.20
M20	1.5	18.09	17.84	10.12	10.03	10.25	9.75	5.00	10.23
M22	1.5	20.09	19.84	10.12	10.03	10.25	9.75	5.00	10.23
M24	1.5	22.22	21.97	12.13	12.04	12.25	11.75	6.00	12.28
M26	1.5	24.22	23.97	12.13	12.04	12.25	11.75	6.00	12.28
M30	1.5	28.22	27.97	17.15	17.05	12.25	11.75	6.00	17.30



Features 3/4" taper. Precision thread for positive seal without sealing compound; controlled chamfer for faster starting.

Mechanical Properties

Heat Treatment: 35-40 HRC

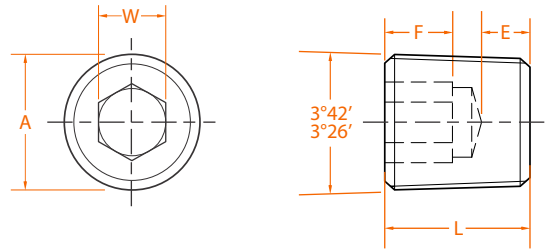

Product Dimensions

Plug Size	Threads per Inch	Head Diameter A		Hex Socket Size W nom	Socket Depth F min	Length L	
		max	min			max	min
1/8	28	0.329	0.319	0.1875	0.183	0.385	0.365
1/4	19	0.438	0.428	0.2500	0.245	0.510	0.490
3/8	19	0.578	0.568	0.3125	0.276	0.573	0.553
1/2	14	0.731	0.721	0.3750	0.339	0.698	0.678
5/8	14	0.808	0.798	0.5000	0.370	0.760	0.740
3/4	14	0.946	0.936	0.5625	0.370	0.823	0.803
7/8	14	1.098	1.088	0.5625	0.442	0.885	0.865
1	11	1.181	1.171	0.6250	0.558	1.010	0.990
1 1/4	11	1.530	1.520	0.7500	0.677	1.260	1.240
1 1/2	11	1.754	1.744	0.7500	0.677	1.260	1.240

Plug Size	E min	Socket Drill Size
1/8	0.076	0.1923
1/4	0.107	0.2564
3/8	0.139	0.3205
1/2	0.170	0.3847
5/8	0.170	0.5129
3/4	0.232	0.5770
7/8	0.232	0.5770
1	0.232	0.6400
1 1/4	0.300	0.7680
1 1/2	0.300	0.7680



Features 3/4" and 7/8" tapers. Dryseal thread for positive seal without sealing compound; controlled chamfer for faster starting

Application Data

Unbrako recommends using a tapered reamer with corresponding size tap drill

Notes

- +With use of reamer (taper thread).
- ++Without use of tapered reamer.
- *Recommended torques for alloy steel only.
- Multiply by .65 for stainless steel and .50 for brass.
- NPTF fully formed Dryseal threads achieve seal in tapped holes without need for sealing compounds.

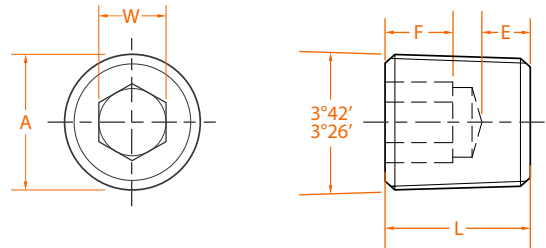

Product Dimensions

Thread size nom	Thread per Inch	Head Diameter A ref	Hex Socket Size		Length (±.010) L max	Socket Depth F min
			W nom	E min		
1/16	27	.318	.156	.062	.312	.140
1/8	27	.411	.188	.062	.312	.140
1/4	18	.545	.250	.073	.437	.218
3/8	18	.684	.312	.084	.500	.250
1/2	14	.847	.375	.095	.562	.312
3/4	14	1.061	.562	.125	.625	.312
1	11 1/2	1.333	.625	.125	.750	.375
1 1/4	11 1/2	1.679	.750	.126	.812	.437
1 1/2	11 1/2	1.918	1.000	.156	.812	.437
2	11 1/2	2.395	1.000	.156	.875	.437

Thread size nom	Tap Drill Size+	Tap Drill Size++	recommended torque in.-lbs*
1/16	15/64	1/4	150
1/8	21/64	11/32	250
1/4	27/64	7/16	600
3/8	9/16	37/64	1200
1/2	11/16	23/32	1800
3/4	57/64	59/64	3000
1	1 1/8	1 5/32	4200
1 1/4	37.5mm	-	5400
1 1/2	43.5mm	-	6900
2	2 3/16	-	8500



Levl-seal features: controlled 7/8" taper in 3/4" taper hole seats plug level, flush with surface within 1/2 pitch.

Mechanical Properties

1. Material: ASTM A574 alloy steel, austenitic stainless steel or brass.
2. Hardness: Rc 35-40 for steel.
3. DRY-SEAL and LEVL-SEAL: Small end of plug to be flush with face of standard NPTF ring gages within one thread (L1, L2 and tapered ring). Large end of plug to be flush with face of special 7/8 taper ring gages within one-half thread.
4. Undercut in socket at mfrs. option
5. Six equally spaced identification grooves (1/16-27 plug to have 3 identification grooves) on alloy steel plugs. (LEVL-SEAL)
6. Dimensions apply before plating and/or coating.

Notes

- * for taper thread (using tapered reamer)
- ** Maximum for PTFE / Teflon-coated but can be reduced as much as 60% in most applications.

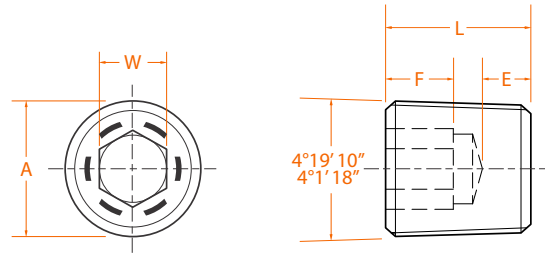

Product Dimensions

Thread size nom	Thread per Inch min	Head Diameter A ref	Hex Socket Size W nom	E min	Length (+0, -.015)		Socket Depth F min
					L max	L min	
1/16	27	.307	.156	.052	.250	.141	
1/8	27	.401	.188	.049	.250	.141	
1/4	18	.529	.250	.045	.406	.266	
3/8	18	.667	.312	.040	.406	.266	
1/2	14	.830	.375	.067	.531	.329	
3/4	14	1.041	.562	.054	.531	.329	
1	11 1/2	1.302	.625	.112	.656	.360	
1 1/4	11 1/2	1.647	.750	.102	.656	.360	
1 1/2	11 1/2	1.885	.750	.102	.656	.360	
2	11 1/2	2.360	1.000	.084	.656	.360	

Thread size nom	tap drill size*	Recommended torque (inch-lbs.) alloy steel**
1/16	15/64	150
1/8	21/64	250
1/4	27/64	600
3/8	9/16	1,200
1/2	11/16	1,800
3/4	57/64	3,000
1	1 1/8	4,200
1 1/4	37.5mm	5,400
1 1/2	43.5mm	6,900
2	2 3/16	8,500

Head Marking

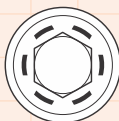

Taper Pressure Plugs - Metric



Size	Part No.		lbs /1000
DIN906.22 - Grade 5.8			
M8 (1.0)	402218	100	4.40
M10 (1.0)	402219	100	7.48
M12 (1.5)	402220	100	14.08
M16 (1.5)	402221	100	24.20
M18 (1.5)	402222	100	35.20
M20 (1.5)	402223	100	38.72
M22 (1.5)	402224	100	46.20

Taper Pressure Plugs - Inch



Size	Part No.		lbs /1000
BSPT 3/4" Taper Alloy Steel			
1/8-28	402208	200	9.31
1/4-19	402209	200	22.33
3/8-19	402210	100	41.51
1/2-14	402211	100	75.90
5/8-14	402212	50	99.51
3/4-14	402213	50	150.15
1-11	402214	25	294.47
1 1/4-11	402215	25	598.40
1 1/2-11	402216	25	756.80
NPTF 3/4" Taper / Dryseal Alloy Steel			
1/16-27	117052	100	4.40
1/8-27	117068	100	11.00
1/4-18	117084	100	19.18
3/8-18	118963	100	37.40
1/2-14	103846	50	61.60
3/4-14	103747	50	101.64
1-11.5	103644	25	202.40
1 1/4-11.5	103588	25	360.80

Size	Part No.		lbs /1000
NPTF 3/4" Taper / Dryseal Brass			
1/16-27	102940	100	3.96
1/8-27	103266	100	9.90
1/4-18	103164	100	18.92
3/8-18	103072	100	37.84
NPTF 3/4" Taper / Dryseal Stainless 304			
1/16-27	102262	100	3.96
1/8-27	102182	100	10.12
1/4-18	102076	100	18.92
3/8-18	110890	100	59.84
1/2-14	110779	50	84.04
NPTF 7/8" Taper / LEVL - SEAL Alloy Steel			
1/16-27	107577	100	3.08
1/8-27	107593	100	5.94
1/4-18	105766	100	16.28
3/8-18	105782	100	29.04
1/2-14	112286	50	53.68
3/4-14	109168	50	85.80
1-11.5	109184	50	167.20
1 1/4-11.5	109201	50	286.00

Size	Part No.		lbs /1000
NPTF 7/8" Taper / LEVL - SEAL Teflon Coated			
1/16-27	796087	100	3.08
1/8-27	138240	100	5.94
1/4-18	138241	100	18.33
3/8-18	796086	100	29.04
1/2-14	138243	50	53.68
3/4-14	796088	50	72.60
1-11.5	796089	25	88.00
1 1/4-11.5	796090	25	110.00
NPTF 7/8" Taper / LEVL - SEAL Brass			
1/16-27	134502	100	3.08
1/8-27	134503	100	5.94
1/4-18	134504	100	15.84
3/8-18	134505	100	28.82
1/2-14	134506	50	57.64
NPTF 7/8" Taper / LEVL- SEAL Stainless 304			
1/8-27	183840	100	5.94
1/4-18	183538	100	15.84



Pieces per Box

ALLOY STEEL

BRASS, ALLOY & STAINLESS STEEL

Pins

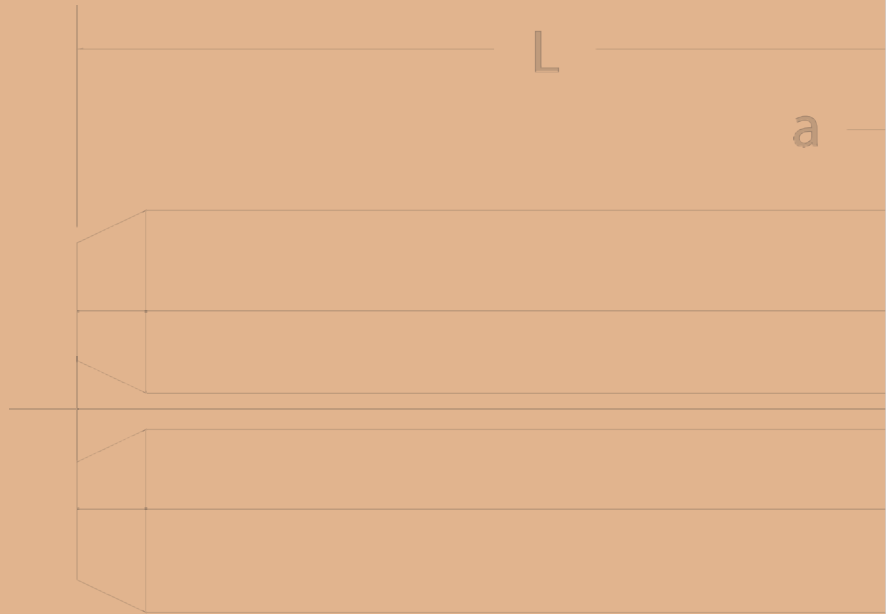

Page	Contents
82	Dowel Pins
87	Pull-Out Dowel Pins





Its about Time & Money...

whether you're an engineer
or purchase manager,
Unbrako has fastening solutions to save
you time & help increase revenue.

Unbrako

DOWEL PINS



Surface hardness: Rockwell "C" 60 minimum
Surface finish: 8 micro inch maximum
Core hardness: Rockwell "C" 50-58
Case depth: .020-inch minimum
Shear strength: 150,000 psi (calculated based on conversion from hardness)

Heat treated alloy steel for strength and toughness
Held to precise tolerance by automatic gaging and electronic feed-back equipment

Material, Heat Treatment, Dimensions: ASME B18.8.2
.0002 – inch oversize typically used for first installation.
.0010 – inch oversize typically used after hole enlarges.

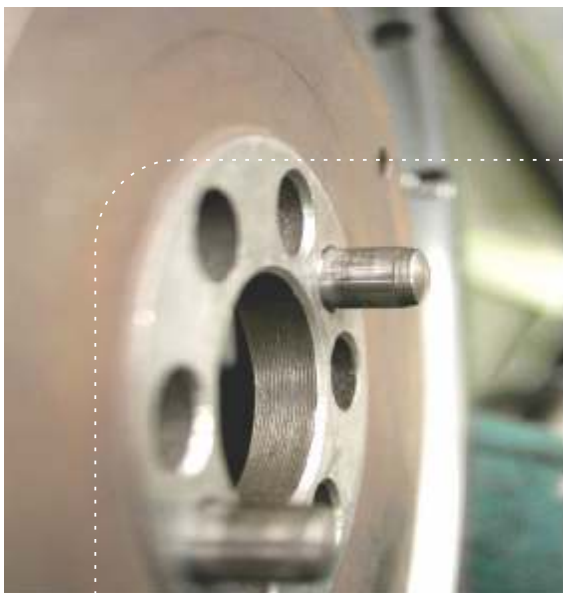

APPLICATIONS

Widely used as plug gages in various production operations, and as guide pins, stops, wrist pins, hinges and shafts. Also used as position locators on indexing machines, for aligning parts, as feeler gages in assembly work, as valves and valve plungers on hydraulic equipment, as fasteners for laminated sections and machine parts, and as roller bearings in casters and truck wheels.

Installation Warning –

Do not strike. Use safety shield or glasses when pressing chamfered end in first.



Continuous grain flow resists chipping of ends. Precision heat treated for greater strength and surface hardness.

Chamfered end provides easier insertion in hole. Surface finish to 8 microinch maximum.



Formed ends, controlled heat treat; close tolerances; standard for die work; also used as bearings, gages, precision parts, etc.

Mechanical Properties

Specifications: ANSI B18.8.5M, ISO 8734 or DIN 6325.

Material: ANSI B18.85-alloy steel

Hardness: Rockwell C60 minimum (surface)

Rockwell C 50-58 (core)

Shear Stress: Calculated values based on 1050 MPa.

Surface Finish: 0.2 micrometer maximum

Application Data

Nominal Size	calculated single shear strength		Recommended hole size	
	kN	lbs	max	min
3	7.4	1,670	3.000	2.987
4	13.2	2,965	4.000	3.987
5	20.6	4,635	5.000	4.987
6	29.7	6,650	6.000	5.987
8	52.5	11,850	8.000	7.987
10	82.5	18,550	10.000	9.987
12	119.0	26,700	12.000	11.985
16	211.0	47,450	16.000	15.985
20	330.0	74,000	20.000	19.983
25	515.0	116,000	25.000	24.983

Warning

Installation warning: Dowel pins should not be installed by striking or hammering.

Wear safety glasses or shield when pressing chamfered point end first.

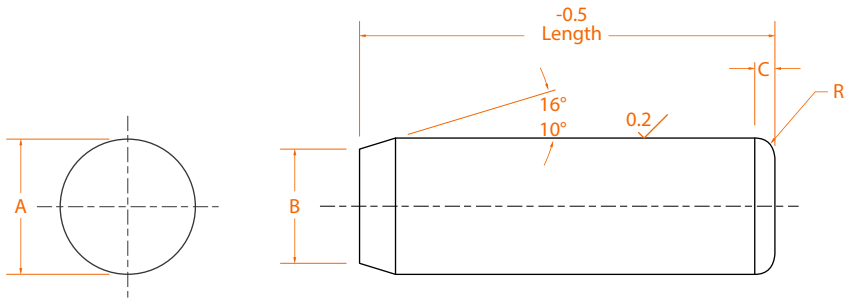



Product Dimensions

Size nom	Pin diameter A		Point diameter B		Crown height C	Crown radius R
	max	min	max	min	max	min
3	3.008	3.003	2.9	2.6	0.8	0.3
4	4.009	4.004	3.9	3.6	0.9	0.4
5	5.009	5.004	4.9	4.6	1.0	0.4
6	6.010	6.004	5.8	5.4	1.1	0.4
8	8.012	8.006	7.8	7.4	1.3	0.5
10	10.012	10.006	9.8	9.4	1.4	0.6
12	12.013	12.007	11.8	11.4	1.6	0.6
16	16.013	16.007	15.8	15.3	1.8	0.8
20	20.014	20.008	19.8	19.3	2.0	0.8
25	25.014	25.008	24.8	24.3	2.3	1.0

Dowel Pins - Metric



Size	Part No.		lbs /1000
2mm			
2 x 8	407831	40	0.43
10	407832	40	0.54
12	407833	40	0.65
16	407835	40	0.87
18	407836	40	0.98
20	407837	40	1.08
3mm			
3 x 10	115001	40	1.22
12	115002	40	1.47
16	115003	40	1.95
18	402118	40	2.20
20	115004	40	2.44
28	402120	40	3.42
30	115007	40	3.66
32	402121	40	3.91
36	406345	40	4.40
40	402124	40	4.89
4mm			
4 x 10	115010	40	2.17
12	115011	40	2.60
16	115012	40	3.47
20	115015	40	4.34
24	407127	40	5.21
25	115016	40	5.43
28	402128	40	6.05
30	115017	40	6.51
50	402132	40	10.85
5mm			
5 x 10	402133	40	3.39
12	115021	40	4.07
14	402134	40	4.75
16	115022	40	5.43
20	115024	40	6.78
24	407128	40	8.14
25	115025	40	8.48
28	402137	40	9.50
30	115026	40	10.17
32	402138	40	10.85
36	406347	40	12.21
40	115028	40	13.56
45	115029	40	15.26
50	115031	40	16.96
6mm			
6 x 12	402141	40	5.86
16	115032	40	7.81

Size	Part No.		lbs /1000
6mm			
6 x 18	402143	40	8.79
20	115034	40	9.77
24	115037	40	11.72
28	402145	40	13.67
30	115038	40	14.65
32	402146	40	15.63
36	406348	40	17.58
40	115043	40	19.53
45	115044	40	21.97
50	115046	40	24.42
60	115047	40	29.30
8mm			
8 x 20	115049	40	17.36
24	406349	40	20.83
28	402150	40	24.31
30	115053	40	26.04
32	402151	40	27.78
36	406350	40	31.25
40	115055	40	34.72
45	115056	40	39.06
50	115057	40	43.40
55	402153	40	47.74
60	115058	40	52.09
10mm			
10 x 20	115063	40	27.13
24	406351	40	32.55
30	115066	40	40.69
36	406352	40	48.83
40	115070	40	54.26
45	115071	40	61.04
50	402161	40	67.82
60	402163	40	81.38
70	402164	40	94.60
90	402167	40	122.07
100	402169	40	135.64
12mm			
12 x 24	406353	40	46.88
30	402174	40	58.59
36	406354	40	70.31
40	402178	40	78.13
50	402180	40	97.66
60	402182	40	117.19
70	402183	40	136.72
80	402184	40	156.26
90	402185	40	175.79
100	402186	40	195.32

Size	Part No.		lbs /1000
16mm			
16 x 32	406218	20	110.00
40	406220	20	138.89
70	406225	20	243.06
80	406226	20	277.79
90	406227	20	312.51

Note:

- Unbrako Dowel Pins are through hardened and precision ground from nominal to 0.0002" over size on Inch sizes and a surface finish of 0.15 micrometers max, on both Metric and Inch products.
- CAUTION: Unbrako advises that correct tools should be used for the application.
- Safety goggles should be worn for your security and protection.



Formed ends, controlled heat treat; close tolerances; standard for die work; also used as bearings, gages, precision parts, etc.

Mechanical Properties

Material: ASME B18.8.2
 Shear Hardness: 150,000 psi
 Surface Hardness: 60 HRC
 Core Hardness: 50 - 58 HRC

Shear Strength and Recommended hole Size

Nominal Size	calculated single shear strength (pounds)	Recommended hole size (.0002 over nom.)	
		max	min
1/16	465	.0625	.0620
3/32	1,035	.0937	.0932
1/8	1,845	.1250	.1245
5/32	2,880	.1562	.1557
3/16	4,140	.1875	.1870
1/4	7,370	.2500	.2495
5/16	11,500	.3125	.3120
3/8	16,580	.3750	.3745
7/16	22,540	.4375	.4370
1/2	29,460	.5000	.4995
9/16	37,270	.5625	.5620
5/8	46,020	.6250	.6245
3/4	66,270	.7500	.7495
7/8	90,190	.8750	.8745
1	117,810	1.0000	.9995

Warning

Installation warning: Do not strike.
 Use safety shield or glasses when pressing chamfered end in first.

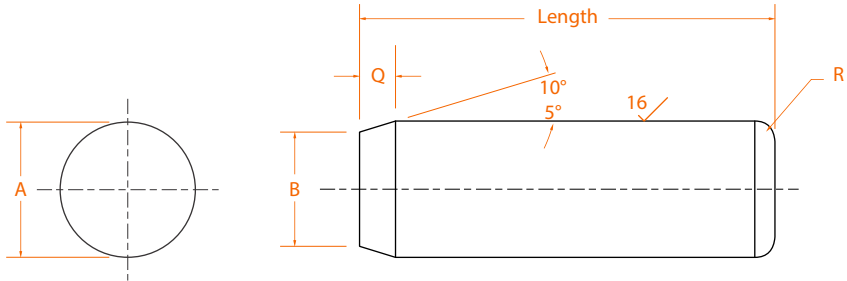

Product Dimensions

Size nom	Pin diameter A		Point diameter B max	Chamfer Q		Crown radius R min
	.0002 over nom. max	min		max	min	
1/16	.0628	.0626	0.056	0.056	0.019	0.010
3/32	.0941	.0939	0.084	0.074	0.028	0.026
1/8	.1253	.1251	0.116	0.070	0.026	0.043
5/32	.1565	.1563	0.147	0.071	0.026	0.043
3/16	.1878	.1876	0.178	0.073	0.027	0.043
1/4	.2503	.2501	0.237	0.093	0.037	0.058
5/16	.3128	.3126	0.298	0.102	0.041	0.058
3/8	.3753	.3751	0.359	0.110	0.046	0.073
7/16	.4378	.4376	0.417	0.136	0.058	0.089
1/2	.5003	.5001	0.480	0.133	0.057	0.104
9/16	.5628	.5626	0.542	0.136	0.058	0.120
5/8	.6253	.6251	0.605	0.133	0.057	0.120
3/4	.7503	.7501	0.725	0.161	0.071	0.120
7/8	.8753	.8751	0.850	0.161	0.071	0.120
1	1.0003	1.0001	0.975	0.161	0.071	0.120

Dowel Pins - Inch



Size	Part No.		lbs /1000	Size	Part No.		lbs /1000	Size	Part No.		lbs /1000
1/8"				3/8"				3/4"			
1/8" x 3/8	116081	40	1.67	3/8" x 1/2	117593	40	19.80	3/4" x 2	106412	10	250.05
1/2	116097	40	1.74	5/8	109422	40	22.55	2 1/2	106444	10	334.40
5/8	116113	40	2.17	3/4	109454	40	31.26	3	106477	10	375.08
3/4	116129	40	2.60	7/8	109486	40	32.45	3 1/2	106509	10	462.00
7/8	116146	40	4.95	1	109520	40	35.20	4	113456	10	500.11
1	116162	40	3.47	1 1/4	114998	40	39.07	5	113521	10	625.14
1 1/4	116179	40	4.34	1 1/2	115030	40	46.89	6	111925	10	770.00
1 1/2	116195	40	4.95	1 3/4	115062	40	54.70	7/8"			
1 3/4	110261	40	10.45	2	113097	40	62.51	7/8" x 2	111958	10	374.00
2	110277	40	12.65	2 1/4	109028	40	75.90	3	108424	10	539.00
3/16"				7/16"				1"			
3/16" x 1/2	110293	40	3.91	7/16" x 1	107686	20	49.50	1" x 2	102968	10	444.54
5/8	110310	40	4.88	1 1/4	107718	20	59.40	2 1/2	107094	10	552.00
3/4	110327	40	5.86	1 1/2	113240	20	70.40	3	107126	10	710.60
7/8	110344	40	7.70	1 3/4	107457	20	84.70	3 1/2	104251	10	777.95
1	110360	40	7.81	2	107489	20	94.60	4	104317	10	924.00
1 1/4	110376	40	9.90	2 1/2	107521	20	114.40	5	108138	10	1067.00
1 1/2	110393	40	12.65	3	107553	20	134.20				
1 3/4	110410	40	14.85	1/2"							
2	110426	40	17.60	1/2" x 3/4	117073	20	41.68				
1/4"				5/8"							
1/4" x 1/2	104185	40	10.42	5/8" x 1	107650	10	86.83				
5/8	115069	40	9.90	1 1/4	107682	10	110.00				
3/4	113104	40	10.42	1 1/2	107714	10	173.65				
7/8	105237	40	13.75	1 3/4	121862	10	160.70				
1	108942	40	13.89	2	107453	10	189.20				
1 1/4	108974	40	17.36	2 1/4	107485	10	209.00				
1 1/2	105277	40	20.84	2 1/2	107517	10	217.06				
1 3/4	105309	40	23.96	3	107549	10	268.40				
2	105341	40	24.31	3 1/2	107582	10	310.20				
2 1/4	118645	40	33.00	4	107614	10	358.60				
2 1/2	120490	40	37.40	4 1/2	113268	10	409.20				
5/16"				5/8"							
5/16" x 1/2	120557	40	12.65	5/8" x 1	107650	10	86.83				
5/8	120621	40	14.85	1 1/4	107682	10	110.00				
3/4	117265	40	16.28	1 1/2	107714	10	173.65				
7/8	117298	40	18.99	1 3/4	121862	10	160.70				
1	117331	40	21.71	2	107453	10	189.20				
1 1/4	117363	40	29.70	2 1/4	107485	10	209.00				
1 1/2	117397	40	35.20	2 1/2	107517	10	217.06				
1 3/4	117429	40	42.35	3	107549	10	268.40				
2	117462	40	43.41	3 1/2	107582	10	310.20				
2 1/4	117494	40	48.84	4	107614	10	358.60				
2 1/2	117527	40	59.95	4 1/2	113268	10	409.20				
3	117561	40	69.85	5	113300	10	440.00				

Note:

- Unbrako Dowel Pins are through hardened and precision ground from nominal to 0.0002" over size on Inch sizes and a surface finish of 0.15 micrometers max, on both Metric and Inch products.
- CAUTION: Unbrako advises that correct tools should be used for the application.
- Safety goggles should be worn for your security and protection.

PULL-OUT DOWEL PINS



5 WAYS TO SAVE

UNBRAKO Pull-Out Dowel Pins are easier, more accurate and more economical than “do-it-yourself” modifications of standard dowels. They save you money FIVE ways:

1. YOU SAVE COST OF SEPARATE KNOCK-OUT HOLES IN BLIND HOLES WHERE PINS MUST BE REMOVED.

UNBRAKO pull-out pins are easy to install in blind holes, easy to remove. Exclusive spiral grooves release trapped air for insertion or removal without danger of hole-scoring.

2. YOU MUST SAVE COST OF NEW PINS EACH TIME DIE IS SERVICED OR DISMANTLED.

UNBRAKO pull-out dowel pins are reusable. The hole tapped in one end for a removal screw or threaded “puller” makes it easy and fast to remove the pin without damage to pin or hole, permits repeated re-use.

3. YOU SAVE MONEY IN REDUCED DOWNTIME AND LOSS OF PRODUCTION

UNBRAKO pull-out dowel pins speed up die servicing and reworking. You can remove them without turning the die over, and you can take out individual sections of the die for rework or service without removing entire die assembly from the press.

4. YOU SAVE MODIFICATIONS COSTS, YOU AVOID HEADACHES AND YOU SAVE YOUR SKILLED PEOPLE FOR PROFITABLE WORK.

UNBRAKO pull-out dowel pins have tapped holes and relief grooves built in. Time-consuming “do-it-yourself” modification of standard pin eliminated. No need for annealing (to make pins soft enough to drill and tap) and re-hardening, which can result in damage to finish, and in inaccuracies and distortion.

5. YOU SAVE TIME AND MONEY BECAUSE OF THIS QUALITY “REPEATABILITY”. NO SPECIAL PREPARATION OF INDIVIDUAL HOLES NEEDED- YOU CAN BE SURE OF ACCURATE FIT EVERY TIME.

UNBRAKO pull-out dowel pins are identical and interchangeable with standard UNBRAKO dowels. They have the same physical, finish, accuracy and tolerances. And they are consistently uniform. Their exclusive spiral relief grooves provide more uniform relief than other types of removable pins, assuring more uniform pull-out values.

You don't need any special tools to remove UNBRAKO pull-out dowels-just an ordinary die hook and a socket head cap or button head socket screw.

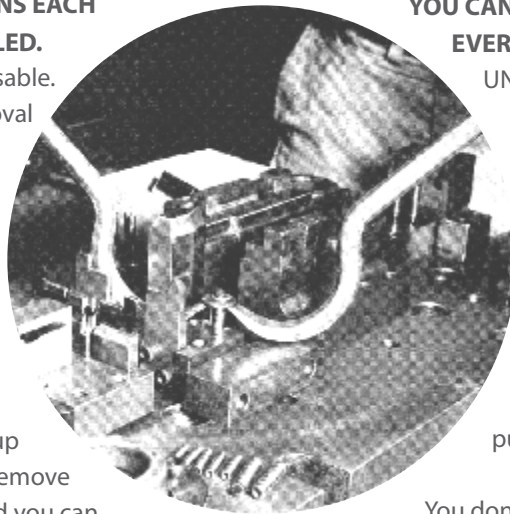

FEATURES

Formed ends resist chipping

Exclusive spiral grooves afford uniform relief for insertion and removal, reduce chances of hole-scoring

Tapped hole for easy pull-out (ANSI B1.1)



Surface hardness-Rockwell C60 minimum
Surface finish-8 micro inch maximum
Core hardness-Rockwell C 50-58

Shear strength: 150,000 psi (calculated based on conversion from hardness)

Heat treated alloy steel for strength and toughness

Held to precise tolerance



For use in blind holes. Easily removed without special tools. Reusable, Saves money. No need for knock-out holes. Same physicals & finish as standard Unbrako dowel pins.

Mechanical Properties

Material and Heat Treatment: ASME B18.8.2
Length equal to shorter than 'p' max values may be drilled through

Shear Strength and Recommended hole Size

Nominal Size	Single Shear Strength (lbs) ref.	Recommended hole diameter	
		max	min
1/4	7,370	.2500	.2495
5/16	11,500	.3125	.3120
3/8	16,580	.3750	.3745
7/16	22,540	.4370	.4315
1/2	29,460	.5000	.4995
5/8	46,020	.6250	.6245
3/4	66,270	.7500	.7495
7/8	90,190	.8750	.8745
1	117,810	1.0000	.9995

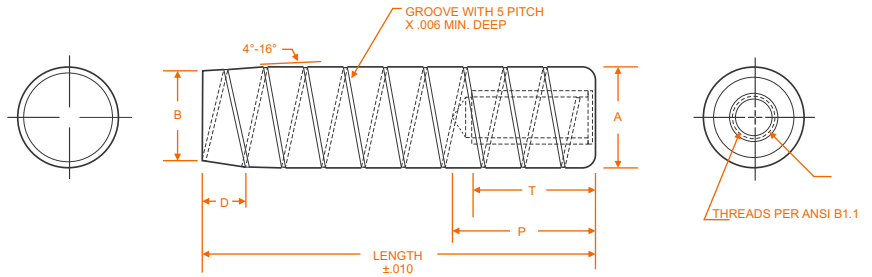

Product Dimensions

Nominal Size	Thread size	B max	A		D min	P max	T min
			max	min			
1/4	#8-32 UNC-2B	.237	.2503	.2501	.031	.500	.212
5/16	#10-32 UNF-2B	.302	.3128	.3126	.034	.625	.243
3/8	#10-32 UNF-2B	.365	.3753	.3751	.038	.625	.243
7/16	#10-32 UNF-2B	.424	.4378	.4376	.047	.625	.243
1/2	1/4-20 UNC-2B	.486	.5003	.5001	.047	.750	.315
5/8	1/4-20 UNC-2B	.611	.6253	.6251	.047	.750	.315
3/4	5/16-18 UNC-2B	.735	.7503	.7501	.059	.875	.390
7/8	3/8-16 UNC-2B	.860	.8753	.8751	.059	.875	.390
1	3/8-16 UNC-2B	.980	1.0003	1.0001	.059	.875	.390

Pull-Out Dowel Pins - Inch

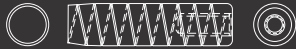

HIGH-GRADE ALLOY STEEL

Size	Part No.		lbs /1000
1/4" (#8-32 UNC)			
1/4" x 3/4	138431	40	12.65
1	138433	40	14.85
1 1/4	138434	40	17.60
1 1/2	138436	40	22.55
1 3/4	138437	40	24.75
2	138438	40	29.70
2 1/2	138440	40	37.40
5/16" (#10-32 UNF)			
5/16" x 3/4	138441	40	17.60
1	138443	40	24.75
1 1/4	138444	40	29.70
1 1/2	138445	40	35.20
2	138447	40	47.30
2 1/4	138448	40	51.15
2 1/2	138449	40	59.95
3/8" (#10-32 UNF)			
3/8" x 1	138451	40	35.20
1 1/4	138452	40	39.67
1 1/2	138453	40	46.89
1 3/4	138454	40	54.70
2	138455	40	62.51
2 1/4	138456	40	75.90
2 1/2	138457	40	84.70
3	138458	40	93.77
1/2" (1/4-20 UNC)			
1/2" x 1	135459	40	61.60
1 1/4	135460	40	75.90
1 1/2	138461	20	90.20
1 3/4	138462	20	104.50
2	138463	20	119.90
2 1/4	138464	20	134.20
2 1/2	138465	20	149.60
3	138466	20	174.90
3 1/2	138467	20	204.60
4	138468	20	234.30

 Pieces per Box

Size	Part No.		lbs /1000
5/8" (1/4-20 UNC)			
5/8" x 1 1/2	138469	20	70.40
2	138471	20	94.60
2 1/4	138472	10	209.00
2 1/2	138473	10	228.80
3	138474	10	268.40
4	138476	10	358.60
3/4" (5/16-18 UNC)			
3/4" x 2	138477	10	268.4
2 1/2	138478	10	334.4
3	138479	10	398.2
4	138480	10	528.0
1" (3/8-16 UNC)			
1" x 2	138481	10	479.6
2 1/2	138482	10	589.6
3	138483	10	710.6
4	138485	10	850.7

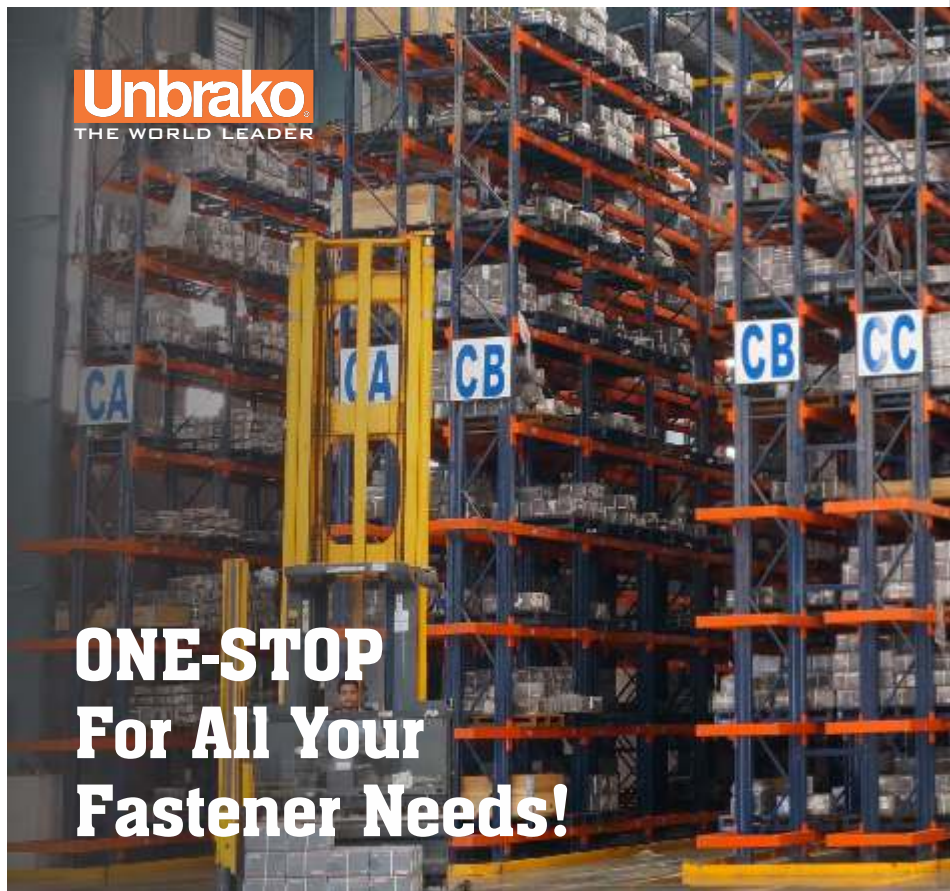

**ONE-STOP
For All Your
Fastener Needs!**

With up to 9 months inventory cover for standard products
More than 3,000 categories of High Tensile Alloy and Stainless Steel
Industrial Fasteners are just a call away!

Wrenches & Tools

W

A

B

Page	Contents
92	Hexagon Wrenches - Metric
94	Hexagon Wrenches - Inch



Its about Safety & Reliability...

Using unbrako tools says a lot:

You're proud,
You're professional,
You don't cut corners.

HEXAGON WRENCHES

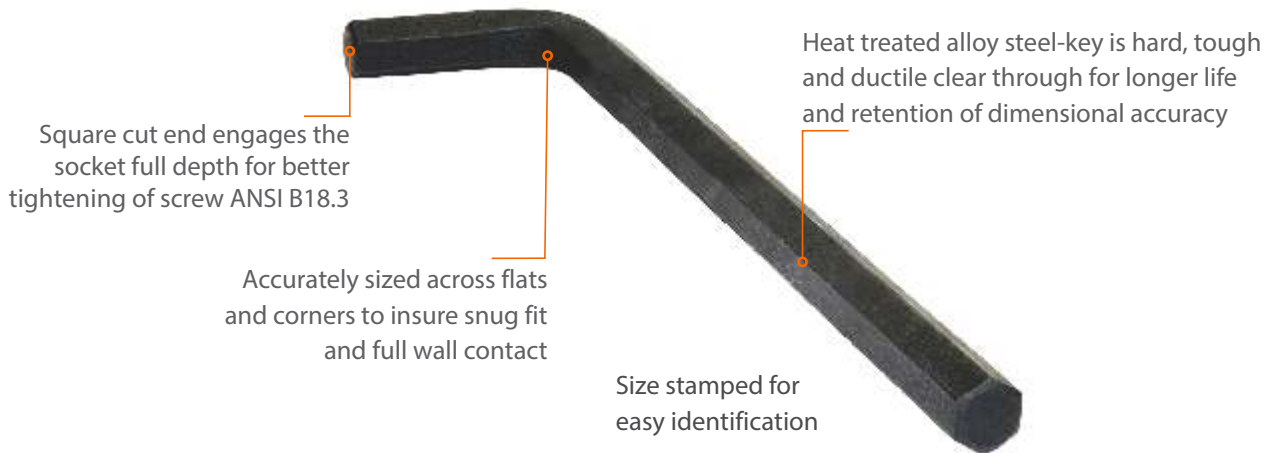

Why Unbrako wrenches are Safer ?

An UNBRAKO key is not an ordinary hexagon key – it is a precision internal wrenching tool of great strength and ductility. With an UNBRAKO key, far more tightening torque than is needed can be applied without damaging the screw or the key, and it can be done safely. This is an important feature, especially true of the smaller sizes (5/32" and under) which are normally held in the hand.

Photographs of a destruction test show what we mean. Under excessive torque a 5/64" UNBRAKO key twists but does not shear until a torque has been reached that is approximately 20% greater than can be applied with an ordinary key. At his point it shears off clean, flush with the top of the socket, leaving no jagged edge to gash a hand.

Still the UNBRAKO screw has not been harmed. The broken piece of the key is not wedged into the socket. It can be lifted out with a small magnet, convincing proof that the socket has not been reamed or otherwise damaged.

NOTE: The use of an extension in these illustrations is for demonstration purposes only. The manufacturer does not recommend the use of extensions with any hex key product under normal conditions.



A 5/64" UNBRAKO key will twist up to 180° without weakening.

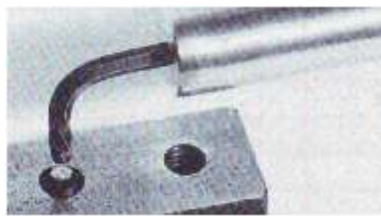

Twisted to about 270°, the key shears off clean. Note the extension bar illustrated for test purposes only.



The socket hasn't been reamed or damaged. Broken section can be lifted out with a magnet.



Tough, ductile, for high torqueing; accurate fit in all types of socket screws; size marked for quick identity

Mechanical Properties

1. Material: ASME B18.3.2.M Alloy Steel
2. Dimensions: B18.3.2M
3. Similar Standards: ISO 2936 AND BS4168
4. Unbrako Long arm similar to ISO extra long
5. Please specify standard required at time of purchase.

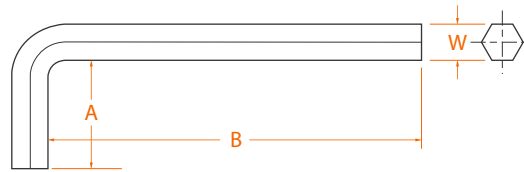

Product Dimensions

Size nom.	Width Across Flats W		A		Unbrako / ASME Short B		Unbrako Long B	
	max.	min.	max.	min.	max.	min.	max.	min.
0.71	0.711	0.698	5.5		31			
0.89	0.889	0.876	9		31			
1.27	1.270	1.244	13.5		42			
1.5	1.500	1.470	14	13	45	43	90	88
2.0	2.000	1.970	16	15	50	48	100	98
2.5	2.500	2.470	18	17	56	53	112	109
3.0	3.000	2.955	20	19	63	60	126	123
4.0	4.000	3.955	25	24	70	66	142	138
5.0	5.000	4.955	28	27	80	76	160	156
6.0	6.000	5.955	32	30	90	86	180	176
8.0	8.000	7.955	36	34	100	95	200	195
10.0	10.000	9.955	40	38	112	106	224	218
12.0	12.000	11.955	45	43	125	119	250	244
14.0	14.000	13.930	55	53	140	133	280	273
17.0	17.000	16.930	63	60	160	152	320	312
19.0	19.000	18.930	70	67	180	171	360	351
22.0	22.000	21.930	80	76	200	190	400	390
24.0	24.000	23.930	90	86	224	213	448	437
27.0	27.000	26.820	100	96	250	238	500	488
32.0	32.000	31.820	125	121	315	300	630	615
36.0	36.000	35.820	140	135	355	338	710	693

Size nom.	ASME Long B		Torsional Shear Strength Minimum		Torsional Yield Strength Minimum	
	max.	min.	N-m	In-lbs.	N-m	In-lbs.
0.71	69		0.12	1.1	0.1	0.9
0.89	71		0.26	2.3	0.23	2.
1.27	75		0.73	6.5	.63	5.6
1.5	78	76	1.19	10.5	1.02	9.0
2.0	83	81	2.90	26	2.4	21
2.5	90	87	5.40	48	4.4	39
3.0	100	97	9.30	82	8.0	71
4.0	106	102	22.2	196	18.8	166
5.0	118	114	42.7	378	36.8	326
6.0	140	136	74.0	655	64	566
8.0	160	155	183.0	1,620	158	1,400
10.0	170	164	345.0	3,050	296	2,620
12.0	212	206	634.0	5,610	546	4,830
14.0	236	229	945.0	8,360	813	7,200
17.0	250	242	1,690	15,000	1,450	12,800
19.0	280	271	2,360	20,900	2,030	18,000
22.0	335	325	3,670	32,500	3,160	28,000
24.0	375	364	4,140	36,600	3,560	31,500
27.0			5,870	51,900	5,050	44,700
32.0			8,320	73,600	7,150	63,300
36.0			11,800	104,000	10,200	90,300

Marking



Sizes 2 or Larger



Size	Part No.		lbs /1000
Short Series			
0.71	110230	100	0.26
0.89	115932	100	1.36
1.27	115965	100	2.27
1.5	125648	100	2.84
2.0	122263	100	4.99
2.5	122270	100	8.73
3.0	121093	100	13.18
4.0	119953	100	26.60
5.0	122245	100	44.24
6.0	121066	50	71.87
8.0	115557	50	133.36
10.0	120859	25	225.54
12.0	120860	25	354.71
14.0	111100	25	545.56
17.0	138487	10	941.60
19.0	111133	10	1349.77
22.0	402603	1	2026.20
24.0	402604	1	2706.00
27.0	402605	1	3843.40
32.0	402606	1	6813.40

Size	Part No.		lbs /1000
Long Series (ASME B18.3.2m)			
0.89	C14663	100	0.95
1.5	C04118	100	3.12
2.0	C04119	100	5.94
2.5	C04120	100	10.08
3.0	C04122	100	16.04
4.0	C04123	100	31.46
5.0	C04127	100	54.52
6.0	C04129	50	92.14
8.0	C04130	50	255.64
10.0	C04131	10	314.91
12.0	C04132	10	556.23
14.0	C04133	10	861.78
17.0	C04134	1	1366.07
19.0	C04135	1	1911.58

Note:

- The following Imperial are identical to Metric Sizes : 0.028 ins = 0.71mm, 0.035 ins = 0.89mm, 0.050 ins = 1.27mm. Please order by across flats dimensions and description.
- CAUTION: Unbrako advise that correct tools should be used for the application.
- Safety goggles should be worn for your security and protection.

Metric Wrenches Application Chart

Size nom.	Socket Head Cap screws	Low Head Cap Screws	Flat Head Socket screws	Button Head screws	Socket Set screws
0.71	-	-	-	-	M1.6
0.89	-	-	-	-	M2
1.27	-	-	-	-	M2.5
1.50	M1.6/M2	-	-	-	M3
2.00	M2.5	-	M3	-	M4
2.50	M3	-	M4	-	M5
3.00	M4	M4	M5	M6	M6
4.00	M5	M5	M6	M8	M8
5.00	M6	M6	M8	M10	M10
6.00	M8	M8	M10	M12	M12
8.00	M10	M10	M12	M16	M16
10.00	M12	M12	M16	M20	M20
12.00	M14	M16	-	M24	M24
14.00	M16	M20	-	-	-
17.00	M20	M24	-	-	-
19.00	M24	-	-	-	-
22.00	M30	-	-	-	-
27.00	M36	-	-	-	-
32.00	M42	-	-	-	-
36.00	M48	-	-	-	-





Tough, ductile, for high torqueing; accurate fit in all types of socket screws; size marked for quick identity

Mechanical Properties

Material: ANSI B18.3, alloy steel
Heat treat: Rc 47-57

Torsional Shear and Yield Strength

size nom.	Torsional shear strength	Torsional yield
	inch-lbs. min	inch-lbs. min
.028	1.1	0.9
.035	2.3	2.0
.050	6.5	5.6
1/16	12.2	10.5
5/64	25.0	21.0
3/32	43.0	35.0
7/64	68.0	60.0
1/8	98.0	85.0
9/64	146.0	125.0
5/32	195.0	165.0
3/16	342.0	295.0
7/32	535.0	460.0
1/4	780.0	670.0
5/16	1,600.0	1,370.0
3/8	2,630.0	2,260.0
7/16	4,500.0	3,870.0
1/2	6,300.0	5,420.0
9/16	8,900.0	7,650.0
5/8	12,200.0	10,500.0
3/4	19,500.0	16,800.0
7/8	29,000.0	24,900.0
1	43,500.0	37,400.0
1 1/4	71,900.0	62,500.0
1 1/2	124,000.0	108,000.0
1 3/4	198,000.0	172,000.0
2	276,000.0	240,000.0

Marking

UNBRAKO & Size

Sizes 5/64 or Larger

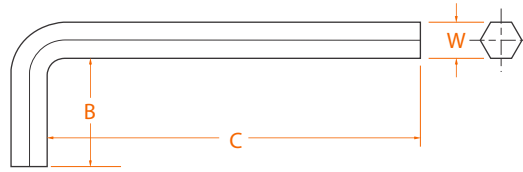

Product Dimensions

size nom.	Width Across Flats W		Length of Short Arm B		C - Length of Long Arm					
	max	min	max	min	short series		long series		6" long arm	
					max	min	max	min		
.028	.0280	.0275	.312	.125	1.312	1.125	2.688	2.500	-	
.035	.0350	.0345	.438	.250	1.312	1.125	2.766	2.578	-	
.050	.0500	.0490	.625	.438	1.750	1.562	2.938	2.750	-	
1/16	.0625	.0615	.656	.469	1.844	1.656	3.094	2.906	-	
5/64	.0781	.0771	.703	.516	1.969	1.781	3.281	3.094	6.000	
3/32	.0937	.0927	.750	.562	2.094	1.906	3.469	3.281	6.000	
7/64	.1094	.1079	.797	.609	2.219	2.031	3.656	3.469	6.000	
1/8	.1250	.1235	.844	.656	2.344	2.156	3.844	3.656	6.000	
9/64	.1406	.1391	.891	.703	2.469	2.281	4.031	3.844	6.000	
5/32	.1562	.1547	.938	.750	2.594	2.406	4.219	4.031	6.000	
3/16	.1875	.1860	1.031	.844	2.844	2.656	4.594	4.406	6.000	
7/32	.2187	.2172	1.125	.938	3.094	2.906	4.969	4.781	6.000	
1/4	.2500	.2485	1.219	1.031	3.344	3.156	5.344	5.156	6.000	
5/16	.3125	.3110	1.344	1.156	3.844	3.656	6.094	5.906	6.000	
3/8	.3750	.3735	1.469	1.281	4.344	4.156	6.844	6.656	6.000	
7/16	.4375	.4355	1.594	1.406	4.844	4.656	7.594	7.406	-	
1/2	.5000	.4975	1.719	1.531	5.344	5.156	8.344	8.156	-	
9/16	.5625	.5600	1.844	1.656	5.844	5.656	9.094	8.906	-	
5/8	.6250	.6225	1.969	1.781	6.344	6.156	9.844	9.656	-	
3/4	.7500	.7470	2.219	2.031	7.344	7.156	11.344	11.156	-	
7/8	.8750	.8720	2.469	2.281	8.344	8.156	12.844	12.656	-	
1	1.0000	.9970	2.719	2.531	9.344	9.156	14.344	14.156	-	
1 1/4	1.2500	1.2430	3.250	2.750	11.500	11.000	-	-	-	
1 1/2	1.5000	1.4930	3.750	3.250	13.500	13.000	-	-	-	
1 3/4	1.7500	1.7430	4.250	3.750	15.500	15.000	-	-	-	
2	2.0000	1.9930	4.750	4.250	17.500	17.000	-	-	-	

Size	Part No.		lbs /1000	Size	Part No.		lbs /1000	Size	Part No.		lbs /1000
Short Series				Long Series				6" Long Series			
1/16	108468	100	3.32	1/16	108485	100	4.51	5/64	107503	100	9.90
5/64	110164	100	5.04	5/64	117441	100	7.00	3/32	107504	100	14.30
3/32	110180	100	7.77	3/32	117457	100	10.71	7/64	107505	100	19.80
7/64	110197	100	10.58	7/64	117473	100	14.81	1/8	107507	100	26.40
1/8	110213	100	13.99	1/8	114614	100	19.71	9/64	107508	50	33.00
9/64	115080	100	19.36	9/64	113098	100	26.91	5/32	107509	50	41.80
5/32	110246	100	24.22	5/32	114630	100	33.92	3/16	107511	50	60.50
3/16	115915	100	36.26	3/16	114647	100	51.30	7/32	107513	25	85.80
7/32	115948	50	53.46	7/32	114679	50	75.42	1/4	107514	25	110.00
1/4	115981	50	73.13	1/4	114712	50	103.73	5/16	107515	10	176.00
5/16	115997	50	126.21	5/16	114728	50	179.98	3/8	107516	10	259.60
3/8	116013	25	198.97	3/8	114744	10	285.01				
7/16	116029	25	294.25	7/16	114761	10	423.06				
1/2	116046	25	414.90	1/2	114777	10	598.47				
9/16	116063	25	563.86	9/16	114794	10	814.00				
5/8	116080	10	743.89	5/8	107209	1	1078.48				
3/4	116096	10	1331.84	3/4	107225	1	1873.23				
7/8	116112	5	2050.40	7/8	107242	1	2895.20				
1	116128	5	2983.20	1	107258	1	4219.60				

Note:

- The following Imperial are identical to Metric Sizes : 0.028 ins = 0.71mm, 0.035 ins = 0.89mm, 0.050 ins = 1.27mm. Please order by across flats dimensions and description.
- CAUTION: Unbrako advise that correct tools should be used for the application.
- Safety goggles should be worn for your security and protection.

Inch Wrenches Application Chart

size nom.	1960 Series socket head cap screws	1936 Series socket head cap screws	button head screws	flat head screws	shoulder screws	low heads and socket set screws	pressure* plugs
.028	-	-	-	-	-	#0	-
.035	-	-	#0	#0	-	#1, #2	-
.050	#0	-	#1, #2	#1, #2	-	#3, #4	-
1/16	#1	-	#3, #4	#3, #4	-	#5, #6	-
5/64	#2, #3	#4	#5, #6	#5, #6	-	#8	-
3/32	#4, #5	#5, #6	#8	#8	-	#10	-
7/64	#6	-	-	-	-	-	-
1/8	-	#8	#10	#10	1/4	1/4	-
9/64	#8	-	-	-	-	-	-
5/32	#10	#10	1/4	1/4	5/16	5/16	1/16
3/16	1/4	1/4	5/16	5/16	3/8	3/8	1/8
7/32	-	5/16	3/8	3/8	-	7/16	-
1/4	5/16	-	-	7/16	1/2	1/2	1/4
5/16	3/8	3/8, 7/16	1/2	1/2, 9/16	5/8	5/8	3/8
3/8	7/16, 1/2	1/2, 5/16	5/8	5/8	3/4	3/4	1/2
7/16	9/16	-	-	-	-	-	-
1/2	5/8	5/8	-	3/4	7/8, 1	7/8	-
9/16	-	3/4, 7/8	-	7/8	-	1, 1/8	3/4
5/8	3/4	1	-	1	1 1/4	1 1/4, 1 3/8	1
3/4	7/8, 1	-	-	-	-	1 1/2	1-1/4, 1-1/2
7/8	1 1/8, 1 1/4	-	-	-	1 1/2	-	-
1	1 3/8, 1 1/2	-	-	-	1 3/4	-	1/2, 2
1 1/4	1 3/4	-	-	-	2	-	-
1 1/2	2	-	-	-	-	-	-
1 3/4	2 1/4, 2 1/2	-	-	-	-	-	-
2	2 3/4	-	-	-	-	-	-

* 1 1/2 lvl seal has 3/4" socket
1 1/2 dry seal has 1" socket

HIGH-PERFORMANCE STAINLESS STEEL FASTENERS

Unbrako fasteners are now available in all grades of Stainless Steel A2-70, A2-80, A4-70, A4-80, A4-90 and A4-100.

- Socket Head Cap Screws
- Socket Countersunk Head Screws
- Socket Button Head Screws
- Hex Head Screws
- Hex Nuts
- Plain Washer
- Spring Washer
- Socket Set Screws
- Threaded Rod
- Specials



Extra Strength Where it Counts



Corrosion Resistance

Unbrako Stainless Steel Fasteners - available in SS304 & SS316 - offer excellent corrosion resistance in a wide variety of environments.



LOW Magnetic Permeability

Not attracted by a magnet. Maximum permeability is 1.2. High valuable characteristic in electrical applications.



Performance at HIGH Temperature

Retention of a high percentage of tensile strength and good creep resistance up to 800°F (without scaling or oxidation).



Performance at LOW Temperature

Useful in cryogenic application (like Liquid Nitrogen Gas(LNG) Processing), especially SS304, because it does not become brittle as it is chilled.

Durlok

Page	Contents
101	Durlok® Screws
102	Durlok® Nuts
104	Durlok® Washers

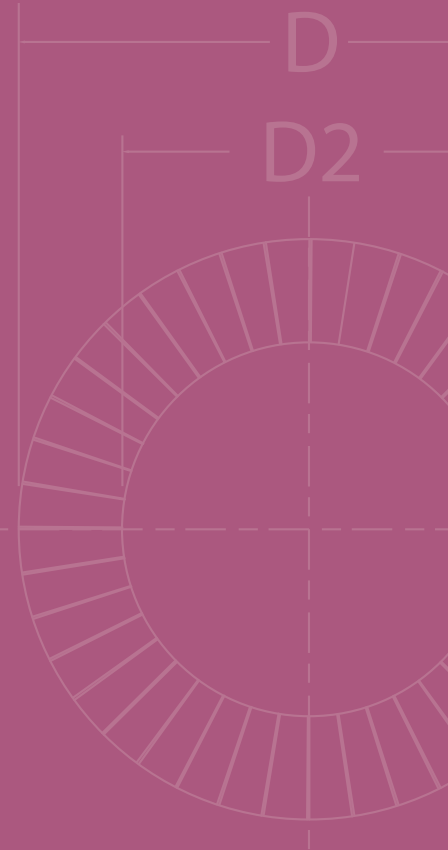

Durlok® Self-locking Anti-vibration Fasteners



Why do fasteners rotate loose under vibration?

The basic design & function of a threaded fastener is to join multi-component assemblies so that the whole assembly performs as a single component.

In most cases, even in preloaded joints, the external forces create minimal relative displacements between the clamped parts, resulting in small sliding movements both in threads and under the head. Thus, the fastener becomes free of friction in a circumferential direction and the internal loosening or "off-torque" created by the preload on the threads will rotate the fastener loose.

In addition to self-loosening, fatigue failures can occur because the fastener will lose preload as soon as partial loosening takes place.

How does DURLOK® work?

Durlok® Free Spinning Self-locking fasteners come with all the benefits of serrated fasteners but with none of the disadvantages. Unlike serrated fasteners, with the unique Durlok® tooth formation, the locking is caused by the elastic spring back of the material at clamping load. A little wall of material builds up behind each tooth thereby blocking the bolt from turning.

Durlok® is designed with long, ramp shaped, radial teeth blended evenly into a smooth slightly conical outer bearing surface. It is this plain outer bearing ring that prevents excessive penetration into the bearing material, together with the long radial teeth which embed with only moderate edge pressure just sufficient to guarantee self-locking.

Durlok® Bolts of strength grade 12.9 are manufactured from alloy steel and are through hardened to give the same hardness from the tooth surface to the core. These are typically heavy duty bolts and can be used for all joints subjected to high loads.

Advantages of DURLOK®

Durlok® Bolts & Nuts are suitable for multiple re-use because the serrations do not groove the clamped material and maintain locking ability.

The Durlok® fastener system is effective on a wide variety of engineering materials including steel both heat-treated and non heat-treated, cast irons including nodular types, non-ferrous metals and sheet materials.

The presence of oil or other lubricants, organic or inorganic coatings will not adversely affect the locking ability. In addition, the corrosion resistance of protected surfaces will generally be maintained because the smooth annular ring of Durlok® fastener shields the bearing area against liquid penetration.

Durlok® Fasteners can be used at elevated temperatures up to 300°C.

How can the self-locking ability be evaluated?

The most commonly used method for measuring locking ability has been by the indirect method of measuring & comparing the tightening & untightening torques. However, there is a growing realization that such a test in no way simulates the self-loosening mechanics of a fastener subjected to vibration. The only way this can be achieved is to apply a vibratory force to the bolted joint & determine whether the fastener rotates loose. This has been attempted but without achieving any real measure of the self-locking ability of the fastener.

There are numerous possibilities of recording test data. However, the clearest presentation of self-locking ability is shown by recording loss of preload versus number of cycles.

A typical recording for both unlocked bolts & bolts supposedly locked with spring washers shows that the initial bolt preload is completely lost after very few test cycles; conclusive evidence that the bolt has undergone total self-loosening.

These results clearly show that spring washers do not possess any genuine self-locking ability.

1. Hex Head Bolt M 10x30 DIN 933-8.8 unlocked.
2. Hex Head Bolt M 10x30 DIN 933-8.8 locked with spring washer according to DIN128B.
3. Hex Head Bolt M 10x30 DIN 933-8.8 locked with spring washer according to DIN 127A.

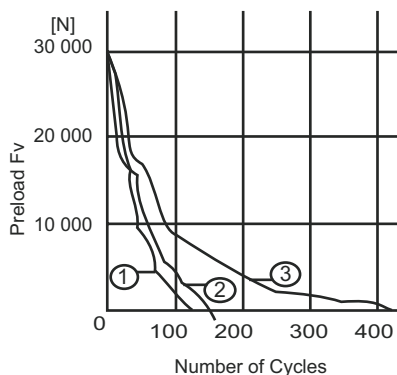

Other advantages of DURLOK.

DURLOK bolts and nuts are suitable for re-use because the serrations cause relatively little damage to the clamped material. This means that the locking ability can be maintained as shown by the original vibration test recorded (see table 3)

This recording shows that the minimal loss of preload due to embedding even decreases due to cold-working of the surface of the clamped material during retightening of the fastener. The DURLOK fastener system is effective on a wide variety of engineering material including steel-both heat-treated & non heat-treated, cast irons including nodular types, non-ferrous metals & sheet materials.

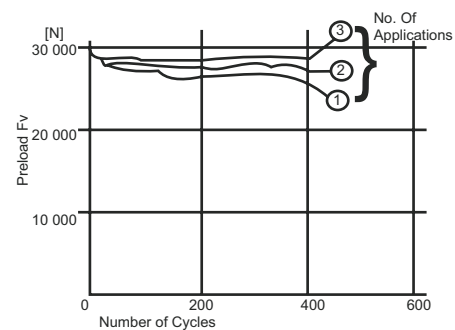

Table 3

DURLOK bolts, however do not rotate loose when tested in the same way, even under the heaviest amplitudes. Even when only half of the recommended preload was used. Durlok bolts still did not loosen. This is illustrated by the figure:2, which is an original recording of a vibration test on M 10 DURLOK bolts. This shows that there is a minimal loss of preload even when the fastener is re-used.

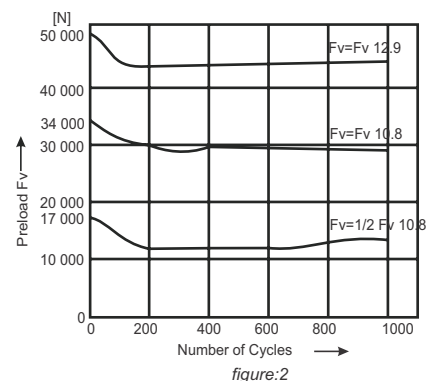

figure:2

Durlok® Self-locking Anti-vibration Fasteners

Will not loosen or unscrew even under the most severe transverse jarring and vibration.

Unique head design ensures absence of 'notch-effect' after assembly

Effectiveness at elevated temperatures upto 300° C is ensured.

Embedding is no greater than with standard types of fasteners.



Reusability is guaranteed with locking ability maintained.

Closely controlled manufacturing for extra safety and reliability.

The DURLOK Advantage

During the 1960's, Dr. Junker while working in Unbrako's Koblenz facility in Germany completed his seminal work on the self-loosening behavior of bolted joints. This in turn led to the design of the original Durlok® anti-vibration nuts & bolts. The Durlok 12.9 nuts & bolts are designed for high-performance critical applications and do not require a washer. However, our industrial OEM customers requested a Durlok product in washer form for applications where it was deemed desirable to use a washer in the joint design. Thus we began researching and developed Unbrako's new Durlok locking wedge washer.

The Durlok® washer when used in combination with standard hex helps achieve self-locking properties. It is an anti-vibration solution that not only prevents bolted joint failure, but also enables the bolted joint to retain its pre-load, thus reducing maintenance requirements. The test regime highlighted this feature (fig 1).



Vibration Resistance Testing / Junker Test

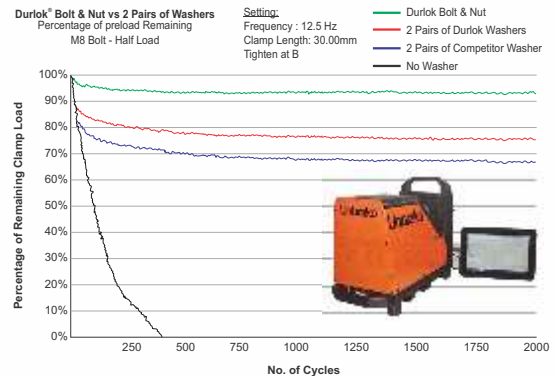

Typical Applications for DURLOK® Fasteners

- Automotive Engines
- Power Unit Accessories
- Transmission Units
- Frames and Chassis Units
- Bodywork
- Vibratory Feeders
- Shaking Chutes, Hoppers

- Electrical equipments
- Construction Machinery and Ancillary Equipments
- Agriculture Machinery
- Percussion Drilling Tools
- &Power Wrenches
- Domestic Appliance





Durlok free spinning self-locking bolts are designed with long, ramp shaped, radial teeth blended evenly into a smooth slightly conical outer surface. Reusable. Self-locking. Anti-vibration.

Mechanical Properties

Property Class: 12.9
 Material: Alloy Steel ISO 898-1
 Hardness: 40 - 43HRc
 Tensile Strength: 1220N/mm² min
 Thread class: 6g
 Threads: ANSI B1.13M, ISO 261, ISO 262 (coarse series only)

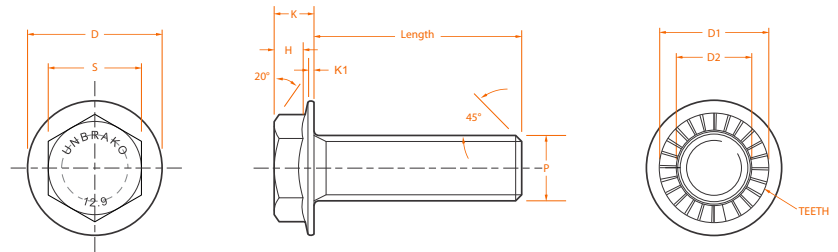

Product Dimensions

Size	D max	D1 min	D2	K nom	K1 min	H min	S max	P max	Length ref
M5	12	11.0	5.5	4.5	1.0	2.09	8	3.65	50.0
M6	14	11.8	6.6	5.2	1.1	2.69	10	4.35	50.0
M8	18	15.2	9.0	7.2	1.3	4.21	13	5.90	60.0
M10	21	17.2	11.0	9.0	1.6	5.47	15	7.50	60.0
M12	25	20.6	14.0	11.0	1.9	6.71	17	9.10	80.0
M14	28	22.8	16.0	12.5	2.2	7.65	19	10.65	80.0
M16	32	25.5	18.0	16.0	3.8	9.27	22	12.55	100.0
M20	39	31.2	22.0	18.0	3.1	11.86	27	15.70	100.0

Application Data

Size	Stress Area mm ²	Proof Load (N)	Load at yield (N)	load at min UTS (N)	Induced preload (N)	Tightening Torque Tmax (Nm) for μ head of		
						0.125	0.16	0.2
M5	14.2	13,750	15,600	17,300	11,300	10.8	12.4	14.2
M6	20.1	19,500	22,100	24,500	15,950	18.2	21.0	24.0
M8	36.6	35,500	40,300	44,600	29,300	44.0	50.0	58.0
M10	58.0	56,300	63,800	70,800	46,600	84.0	96.0	109.0
M12	84.3	81,800	92,700	102,800	68,000	148.0	169.0	194.0
M14	115.0	111,500	126,500	140,000	93,000	233.0	266.0	304.0
M16	157.0	152,000	172,500	191,500	129,000	362.0	413.0	472.0
M20	245.0	238,000	270,000	299,000	201,000	695.0	797.0	913.0

Note
 *Fmax for μ thread =0.125

Marking





Durlok nuts are designed with long, ramp shaped, radial teeth blended evenly into a smooth slightly conical outer surface. For use with Durlok Bolts. Self-locking. Anti-vibration. Reusable.

Mechanical Properties

Material: Alloy Steel ISO 898-1
 Hardness: 28-36HRC
 Thread class: 6H
 Head marking: U 12
 Threads: ANSI B1.13M, ISO 261,
 ISO 262 (coarse series only)
 Property Class: 12

Marking

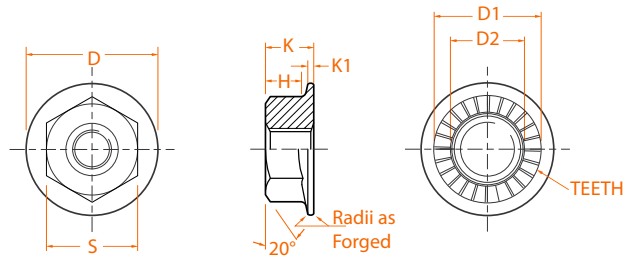

Product Dimensions

Size	D max	D1 min	D2 max	S max	H min	K nom	K1 min
M5	12	10.0	6.2	8	2.46	4.5	1.0
M6	14	11.8	7.4	10	3.06	5.2	1.1
M8	18	15.2	9.5	13	4.60	7.2	1.3
M10	21	17.2	12.5	15	5.90	9.0	1.6
M12	25	20.6	15.0	19	7.45	11.0	1.9
M14	28	23.4	17.0	22	8.55	12.5	2.2
M16	32	26.4	19.0	24	10.25	16.0	2.3
M20	39	32.4	23.0	30	13.05	18.0	2.9

Technical Data

The Durlok fastener system is effective on a wide variety of engineering materials including steel - both heat treated and non-heat treated, cast irons including nodular types, non ferrous metals and sheet materials.

The Presence of oil or other lubricants, organic or inorganic coatings should not adversely affect the locking ability. Durlok Fasteners can be used at elevated temperatures up to 300°C.

The Induced assembly pre-load F_{max} and the corresponding tightening torques, T_{max} are based on a 90% utilisation of the minimum yield strength by combined tension and torsional stresses. For cases where the yield strength must never be exceeded during tightening, the tightening torque must be reduced by a value equivalent to the scatter. Comprehensive investigation has shown that the scatter, due to variations in friction coefficient and torque scatter when tightening with torque wrench, must be accounted for by using a reduced torque T which is 90% of the tabulated value T_{max} , $T = 0.9 \times T_{max}$ Accordingly the induced pre-load F_{max} will be reduced to the new pre-load F , $F = 0.9 \times F_{max}$

It should be noted that pre-load and tightening torque are a function of the joint stiffness. The tabulated values are valid for

a joint stiffness which occurs under snug conditions with a clamping length of 2.5 - 4d. In addition, the values are based on an average friction co-efficient for the threads of $\mu = 0.125$.

The value of the friction coefficient in the bearing area μ_h , has a different value to that of the friction coefficient in the threads μ_t , due to the serrations. As for all bolts the friction coefficient under the head is a function of the material, surface finish and lubrication condition of the contacting materials. To account for this the tightening torques are listed for various values of μ_h .

For guidance the following chart is designed to indicate the appropriate value of friction coefficient to be applied for various engineering materials and finishes. The value of μ_h are based on the results of comprehensive tests:

Coated Surface Bare Bolt Surface	Fine Turning Grinding	Turning, Boring, Milling	Rough Turning Rough Milling
Steel Hardness 250-350 HV	0.125 0.16	0.125 0.160	0.125 0.125
Steel Hardness 150-250HV	0.160 0.20	0.160 0.160	0.160 0.160
Grey cast Iron Nodular Cast Iron	0.20	0.160	0.125

Self-locking Anti-vibration Fasteners

Metric



Durlok® Bolts

Size	Part No.		lbs /1000
M6 (1)			
M6 x 12	190540	200	13.42
16	190560	200	14.94
20	190160	200	16.46
25	190170	200	18.35
30	190180	200	20.24
M8 (1.25)			
M8 x 12	190570	200	28.49
16	190590	200	31.24
20	190210	200	33.99
25	190220	200	37.66
30	190230	200	40.88
35	190600	200	44.31
40	190240	200	47.76
45	408127	200	51.19
50	190610	100	54.63
60	407393	100	61.51
M10 (1.5)			
M10 x 16	190620	200	51.17
20	190270	200	55.53
25	190280	200	60.98
30	190290	200	66.42
35	190630	200	71.87
40	190300	100	77.31
45	190640	100	82.76
50	190310	100	88.20
M12 (1.75)			
M12 x 20	183640	100	86.06
25	190320	100	93.94
30	190330	100	101.84
35	190660	100	109.74
40	190340	50	117.63
45	190670	50	125.53
50	190350	50	133.43
55	190680	50	141.33
60	190360	50	149.23
70	190700	50	165.02
80	190710	50	180.80
M14 (2)			
M14 x 25	190730	25	131.32
30	190370	25	142.12
35	190740	25	152.92
40	190380	25	163.72

Size	Part No.		lbs /1000
M14 x 45	190750	25	174.53
50	190760	25	185.33
60	190770	25	206.93
M16 (2)			
M16 x 30	190410	25	220.42
35	190420	25	234.92
40	190430	25	249.41
45	190820	25	263.91
50	190440	25	278.41
55	405105	25	292.91
60	190450	25	307.38
70	190460	25	336.38
80	190855	25	365.38
90	190860	25	392.48
100	190870	25	423.37
M20 (2.5)			
M20 x 40	190875	25	403.92
45	405793	25	426.92
50	182991	25	449.28
60	190885	25	494.65
70	190890	25	540.03
80	190900	25	585.40
90	190910	25	630.78
100	406937	25	676.15

Durlok® Nuts

Size	Part No.		lbs /1000
Nut			
M6 (1)	404916	200	5.50
M8 (1.25)	404917	200	13.86
M10 (1.5)	405202	200	23.59
M12 (1.75)	404918	100	39.60
M14 (2)	405240	50	69.52
M16 (2)	404915	50	88.00
M20 (2.5)	403618	50	166.96





Durlok washers are designed for use with standard hex bolts & nuts. Self-locking. Anti-vibration.

Mechanical Properties

Material: SAE 4130 or equivalent alloy.
Through Hardened.
Plating: Zinc flake coating (Delta Protekt(R))
Heat treatment: 47-52 HRC

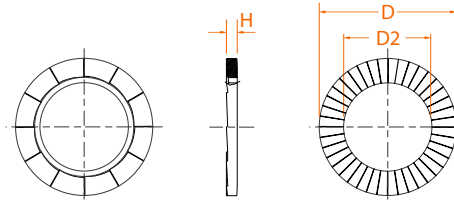

Product Dimensions

Size	D		D2		H	
	min.	max	min.	max	min.	max
6mm	10.60	11.00	6.40	6.60	0.80	1.00
8mm	13.30	13.70	8.60	8.80	1.15	1.35
10mm	16.40	16.80	10.60	10.80	1.15	1.35
12mm	19.30	19.70	12.90	13.10	1.15	1.35
14mm	22.80	23.20	15.10	15.30	1.60	1.80
16mm	25.20	25.60	16.90	17.10	1.60	1.80
20mm	30.50	30.90	21.30	21.50	1.60	1.80
24mm	38.80	39.20	25.30	25.50	1.60	1.80

Product Range

Size	Part No.		lbs /1000
Zinc Flake Coated			
M6	183794	200	0.91
M8	183795	200	1.80
M10	183796	200	2.73
M12	183797	200	3.58
M14	183798	100	5.88
M16	183799	100	8.45
M20	183801	100	11.50

About Durlok Washers

Durlok® locking wedge washers when used with standard or high grade screws helps achieve self-locking properties. It utilizes tension instead of friction to secure bolted joints. Durlok washers come pre-assembled in pairs. They have wedge faces on the inside and radial teeth on the outside. They are designed such that the wedge angle is greater than the thread angle.

When the screw or the nut is tightened the radial teeth of Durlok washer locks itself onto the surface, allowing movement only across the wedge faces. During vibration, even a smallest turn of the screw causes an increase in pre-load force due to the wedge effect and the screw locks itself.

Thus the screw will not loosen or unscrew, even under severe jarring & vibration. Durlok washers are re-usable with locking ability maintained.

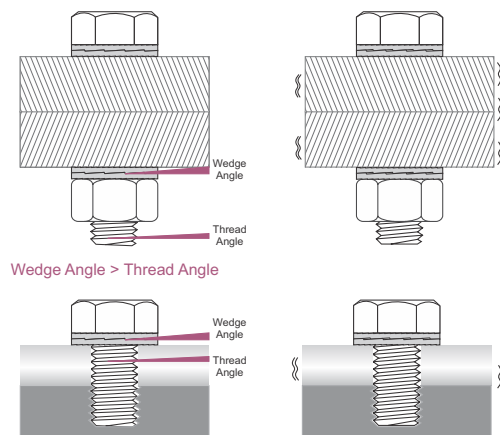

Note: the washers are always used in pairs. For through holes two pairs of Durlok washers should be used. For studbolt Durlok washers lock the nut. Durlok washers must not be used with other flat washers.

Engineering Guide

Technical Section

Page	Contents
106	Screw Fastener Theory and Application
110	Joint Diagrams
116	The Torque-Tension Relationship
118	Stripping Strength of Tapped Holes
122	High-Temperature Joints
125	Corrosion In Threaded Fasteners
129	Impact Performance
133	Product Engineering Bulletin
134	Metric Threads
135	Through-Hole Preparation
136	Drill and Counterbore Sizes
137	Hardness-Tensile Conversion Chart
138	Thread Stress Area
139	Thread Size Comparison
140	Comparison of Different Strength Grades

NOTE:

The technical discussions represent typical applications only. The use of the information is at the sole discretion of the reader. Because applications vary enormously, UNBRAKO does not warrant the scenarios described are appropriate for any specific application. The reader must consider all variables prior to using this information.

INSTALLATION CONTROL

Several factors should be considered in designing a joint or selecting a fastener for a particular application.

JOINT DESIGN AND FASTENER SELECTION.

Joint Length

The longer the joint length, the greater the total elongation will occur in the bolt to produce the desired clamp load or preload. In design, if the joint length is increased, the potential loss of preload is decreased.

Joint Material

If the joint material is relatively stiff compared to the bolt material, it will compress less and therefore provide a less sensitive joint, less sensitive to loss of preload as a result of brinelling, relaxation and even loosening.

Thread Stripping Strength

Considering the material in which the threads will be tapped or the nut used, there must be sufficient engagement length to carry the load. Ideally, the length of thread engagement should be sufficient to break the fastener in tension. When a nut is used, the wall thickness of the nut as well as its length must be considered.

An estimate, a calculation or joint evaluation will be required to determine the tension loads to which the bolt and joint will be exposed. The size bolt and the number necessary to carry the load expected, along with the safety factor, must also be selected.

The safety factor selected will have to take into consideration the consequence of failure as well as the additional holes and fasteners. Safety factors, therefore, have to be determined by the designer.

SHEAR APPLICATIONS

Shear Strength of Material

Not all applications apply a tensile load to the fastener. In many cases, the load is perpendicular to the fastener in shear. Shear loading may be single, double or multiple loading.

There is a relationship between the tensile strength of a material and its shear strength. For alloy steel, the shear strength is 60% of its tensile strength. Corrosion resistant steels (e.g. 300-Series stainless steels) have a lower tensile/shear relationship and it is usually 50-55%

Single/Double Shear

Single shear strength is exactly one-half the double shear value. Shear strength listed in pounds per square inch (psi) is the shear load in pounds divided by the cross sectional area in square inches.

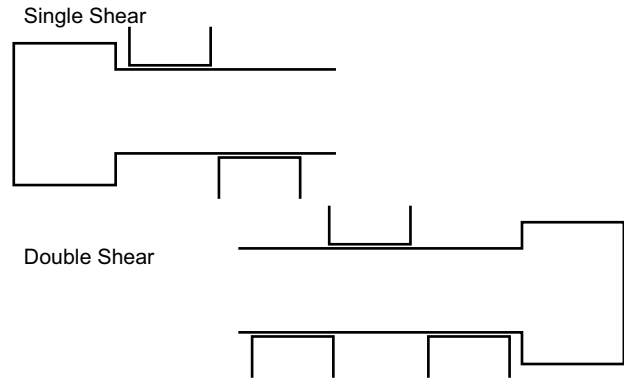

OTHER DESIGN CONSIDERATIONS

Application Temperature

For elevated temperature, standard alloy steels are useful to about 550°F–600°F. However, if plating is used, the maximum temperature may be less (eg. cadmium should not be used over 450°F).

Austenitic stainless steels (300 Series) may be useful to 800°F. They can maintain strength above 800°F but will begin to oxidize on the surface.

Corrosion Environment

A plating may be selected for mild atmospheres or salts. If plating is unsatisfactory, a corrosion resistant fastener may be specified. The proper selection will be based upon the severity of the corrosive environment.

FATIGUE STRENGTH

S/N Curve

Most comparative fatigue testing and specification fatigue test requirements are plotted on an S/N curve. In this curve, the test stress is shown on the ordinate (y-axis) and the number of cycles is shown on the abscissa (x-axis) in a logarithmic scale. On this type curve, the high load to low load ratio must be shown. This is usually $R = .1$, which means the low load in all tests will be 10% of the high load.

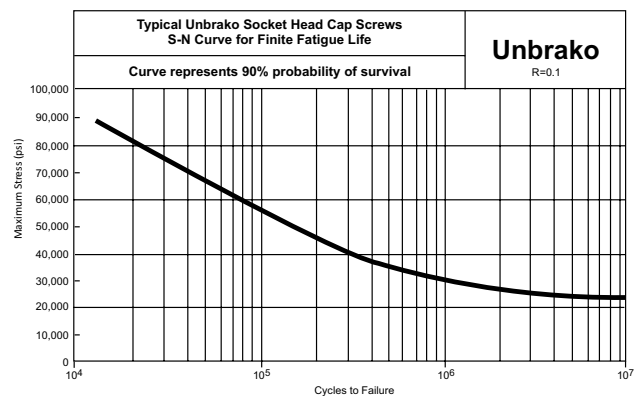

Effect of Preload

Increasing the R to .2, .3 or higher will change the curve shape. At some point in this curve, the number of cycles will reach 10 million cycles. This is considered the

endurance limit or the stress at which infinite life might be expected.

Modified Goodman/ Haigh Soderberg Curve

The S/N curve and the information it supplies will not provide the information needed to determine how an individual fastener will perform in an actual application. In application, the preload should be higher than any of the preloads on the S/N curve.

Therefore, for application information, the modified Goodman Diagram and/or the Haigh Soderberg Curve are more useful. These curves will show what fatigue performance can be expected when the parts are properly preloaded.

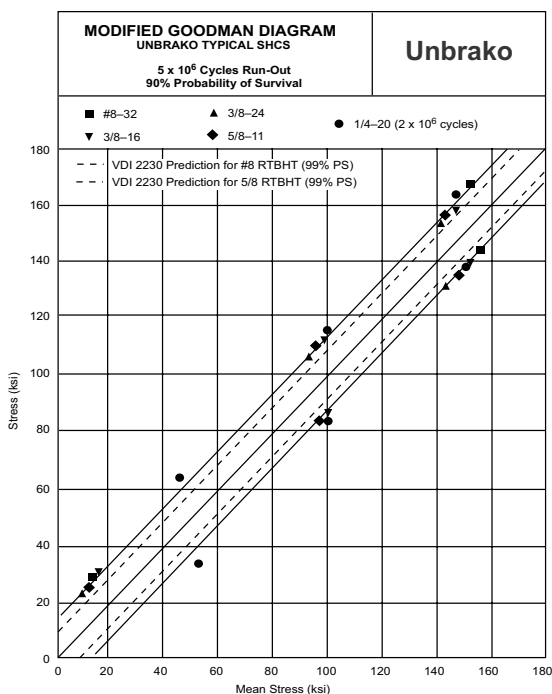

METHODS OF PRELOADING

Elongation

The modulus for steel of 30,000,000 (thirty million) psi means that a fastener will elongate .001 in/in of length for every 30,000 psi in applied stress. Therefore, if 90,000 psi is the desired preload, the bolt must be stretched .003 inches for every inch of length in the joint.

This method of preloading is very accurate but it requires that the ends of the bolts be properly prepared and also that all measurements be very carefully made. In addition, direct measurements are only possible where both ends of the fastener are available for measurement after installation. Other methods of measuring lengths changes are ultrasonic, strain gages and turn of the nut.

Torque

By far, the most popular method of preloading is by torque. Fastener manufacturers usually have recommended seating torques for each size and material fastener. The only requirement is the proper size torque wrench, a conscientious operator and the proper torque requirement.

Strain

Since stress/strain is a constant relationship for any given material, we can use that relationship just as the elongation change measurements were used previously.

Now, however, the strain can be detected from strain gages applied directly to the outside surface of the bolt or by having a hole drilled in the center of the bolt & the strain gage installed internally. The output from these gages need instrumentation to convert the gage electrical measurement method. It is, however, an expensive method and not always practical.

Turn of the Nut

The nut turn method also utilizes change in bolt length. In theory, one bolt revolution (360° rotation) should increase the bolt length by the thread pitch. There are at least two variables, however, which influence this relationship. First, until a snug joint is obtained, no bolt elongation can be measured. The snugging produces a large variation in preload. Second, joint compression is also taking place so the relative stiff nesses of the joint and bolt influences the load obtained.

VARIABLES IN TORQUE

Coefficient of Friction

Since the torque applied to a fastener must overcome all friction before any loading takes place, the amount of friction present is important.

In a standard unlubricated assembly, the friction to be overcome is the head bearing area and the thread-to-thread friction. Approximately 50% of the torque applied will be used to overcome this head-bearing friction and approximately 35% to overcome the thread friction. So 85% of the torque is overcoming friction and only 15% is available to produce bolt load.

If these interfaces are lubricated (cadmium plate, molybdenum disulfide, anti-seize compounds, etc.), the friction is reduced and thus greater preload is produced with the same torque.

The change in the coefficient of friction for different conditions can have a very significant effect on the slope of the torque tension curve. If this is not taken into consideration, the proper torque specified for a plain unlubricated bolt may be sufficient to yield or break a lubricated fastener.

Thread Pitch

The thread pitch must be considered when a given stress is to be applied, since the cross-sectional area used for stress calculations is the thread tensile stress area and is different for coarse and fine threads. The torque recommendations, therefore, are slightly higher for fine threads than for coarse threads to achieve the same stress.

Differences between coarse and fine threads.

Coarse Threads are...

- more readily available in industrial fasteners.
- easier to assemble because of larger helix angle.
- require fewer turns and reduce cross threading.
- higher thread stripping strength per given length.
- less critical of tap drill size.
- not as easily damaged in handling

Their disadvantages are...

- lower tensile strength.
- reduced vibrational resistance.
- coarse adjustment.

Fine Threads provide...

- higher tensile strength.
- greater vibrational resistance.
- finer adjustment.

Their disadvantages are...

- easier cross threaded.
- threads damaged more easily by handling.
- tap drill size slightly more critical.
- slightly lower thread stripping strength.

Other Design Guidelines

In addition to the joint design factors discussed, the following considerations are important to the proper use of high-strength fasteners.

- Adequate thread engagement should be guaranteed by use of the proper mating nut height for the system. Minimum length of engagement recommended in a tapped hole depends on the strength of the material, but in all cases should be adequate to prevent stripping.
- Specify nut of proper strength level. The bolt and nut should be selected as a system.
- Specify compatible mating female threads. 2B tapped holes or 3B nuts are possibilities.
- Corrosion, in general, is a problem of the joint, and not just of the bolt alone. This can be a matter of galvanic action between dissimilar metals. Corrosion of the fastener material surrounding the bolt head or nut can be critical with high-strength bolting. Care must be exercised in the compatibility of joint materials and/or coatings to protect dissimilar metals.

PROCESSING CONTROL

The quality of the raw material and the processing control will largely affect the mechanical properties of the finished parts.

MATERIAL SELECTION

The selection of the type of material will depend on its end use. However, the control of the analysis and quality is a critical factor in fastener performance. The material must yield reliable parts with few hidden defects such as cracks, seams, decarburization and internal flaws.

FABRICATION METHOD

Head

There are two general methods of making bolt heads, forging and machining. The economy and grain flow resulting from forging make it the preferred method.

The temperature of forging can vary from room temperature to 2000°F. By far, the greatest number of parts are cold upset on forging machines known as headers or bolt makers. For materials that do not have enough formability for cold forging, hot forging is used. Hot forging is also used for bolts too large for cold upsetting due to machine capacity. The largest cold forging machines can make bolts up to 1-1/2 inch diameter. For

large quantities of bolts, hot forging is more expensive than cold forging.

Some materials, such as stainless steel, are warm forged at temperatures up to 1000°F. The heating results in two benefits, lower forging pressures due to lower yield strength and reduced work hardening rates.

Machining is the oldest method and is used for very large diameters or small production runs.

The disadvantage is that machining cuts the metal grain flow, thus creating planes of weakness at the critical head-to-shank fillet area. This can reduce tension fatigue performance by providing fracture planes.

Fillets

The head-to-shank transition (fillet) represents a sizable change in cross section at a critical area of bolt performance. It is important that this notch effect be minimized. A generous radius in the fillet reduces the notch effect. However, a compromise is necessary because too large a radius will reduce load-bearing area under the head.

Composite radii such as elliptical fillets, maximize curvature on the shank side of the fillet and minimize it on the head side to reduce loss of bearing area on the load-bearing surface.

Critical Fastener Features

Head-Shank-Fillet: This area on the bolt must not be restricted or bound by the joint hole. A sufficient chamfer or radius on the edge of the hole will prevent interference that could seriously reduce fatigue life. Also, if the bolt should seat on an unchamfered edge, there might be serious loss of preload if the edge breaks under load.

Threads

Threads can be produced by grinding, cutting or rolling. In a rolled thread, the material is caused to flow into the thread die contour, which is ground into the surface during the manufacture of the die. Machines with two or three circular dies or two flat dies are most common.

Thread cutting requires the least tooling costs and is by far the most popular for producing internal threads. It is the most practical method for producing thin wall parts and the only technique available for producing large diameter parts (over 3 inches in diameter).

Thread grinding yields high dimensional precision and affords good control of form and finish. It is the only practical method for producing thread plug gages.

Both machining and grinding have the disadvantage of cutting material fibers at the most critical point of performance.

The shape or contour of the thread has a great effect on the resulting fatigue life. The thread root should be large and well rounded without sharp corners or stress risers. Threads with larger roots should always be used for harder materials.

In addition to the benefits of grain flow and controlled shape in thread rolling, added fatigue life can result when the rolling is performed after heat treatment.

This is the accepted practice for high fatigue performance bolts such as those used in aircraft and space applications.

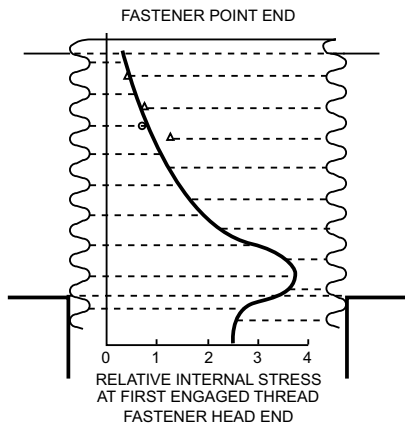

EVALUATING PERFORMANCE

Mechanical Testing

In the fastener industry, a system of tests and examinations has evolved which yields reliable parts with proven performance.

Some tests are conducted on the raw material; some on the finished product.

There always seems to be some confusion regarding mechanical versus metallurgical properties. Mechanical properties are those associated with elastic or inelastic reaction when force is applied, or that involve the relationship between stress and strain. Tensile testing stresses the fastener in the axial direction. The force at which the fastener breaks is called the breaking load or ultimate tensile strength. Load is designated in pounds, stress in pounds per square inch and strain in inches per inch.

When a smooth tensile specimen is tested, the chart obtained is called a Stress-Strain Curve. From this curve, we can obtain other useful data such as yield strength. The method of determining yield is known as the offset method and consists of drawing a straight line parallel to the stress strain curve but offset from the zero point by a specified amount. This value is usually 0.2% on the strain ordinate. The yield point is the intersection of the stress-strain curve and the straight line. This method is not applicable to fasteners because of the variables introduced by their geometry.

When a fastener tensile test is plotted, a load/ elongation curve can be obtained. From this curve, a yield determination known as Johnson's 2/3 approximate method for determination of yield strength is used to establish fastener yield, which will be acceptable for design purposes. It is not recommended for quality control or specification requirements.

Torque-tension testing is conducted to correlate the required torque necessary to induce a given load in a mechanically fastened joint. It can be performed by hand or machine. The load may be measured by a tensile machine, a load cell, a hydraulic tensile indicator or by a strain gage.

Fatigue tests on threaded fasteners are usually alternating tension-tension loading. Most testing is done at more severe strain than its designed service load but usually below the material yield strength.

Shear testing, as previously mentioned, consists of loading a fastener perpendicular to its axis. All shear testing should be accomplished on the un-threaded portion of the fastener.

Checking hardness of parts is an indirect method for testing tensile strength. Over the years, a correlation of tensile strength to hardness has been obtained for most materials. See page 136 for more detailed information. Since hardness is a relatively easy and inexpensive test, it makes a good inspection check. In hardness checking, it is very important that the specimen be properly prepared and the proper test applied.

Stress durability is used to test parts which have been subjected to any processing which may have an embrittling effect. It requires loading the parts to a value higher than the expected service load and maintaining that load for a specified time after which the load is removed and the fastener examined for the presence of cracks.

Impact testing has been useful in determining the ductile brittle transformation point for many materials. However, because the impact loading direction is transverse to a fastener's normal longitude loading, its usefulness for fastener testing is minimal. It has been shown that many fastener tension impact strengths do not follow the same pattern or relationship of Charpy or Izod impact strength.

Metallurgical Testing

Metallurgical testing includes chemical composition, micro structure, grain size, carburization and decarburization, and heat treat response.

The chemical composition is established when the material is melted. Nothing subsequent to that process will influence the basic composition.

The microstructure and grain size can be influenced by heat treatment. Carburization is the addition of carbon to the surface which increases hardness. It can occur if heat treat furnace atmospheres are not adequately controlled. Decarburization is the loss of carbon from the surface, making it softer. Partial decarburization is preferable to carburization, and most industrial standards allow it within limits.

In summary, in order to prevent service failures, many things must be considered:

The Application Requirements

Strength Needed – Safety Factors

- Tension/Shear/Fatigue
- Temperature
- Corrosion
- Proper Preload

The Fastener Requirements

- Material
- Fabrication Controls
- Performance Evaluations

AN EXPLANATION OF JOINT DIAGRAMMS

When bolted joints are subjected to external tensile loads, what forces and elastic deformation really exist? The majority of engineers in both the fastener manufacturing and user industries still are uncertain. Several papers, articles, and books, reflecting various stages of research into the problem have been published and the volume of this material is one reason for confusion. The purpose of this article is to clarify the various explanations that have been offered and to state the fundamental concepts which apply to forces and elastic deformations in concentrically loaded joints. The article concludes with general design formulae that take into account variations in tightening, preload loss during service, and the relation between preloads, external loads and bolt loads.

The Joint Diagram

Forces less than proof load cause elastic strains. Conversely, changes in elastic strains produce force variations. For bolted joints this concept is usually demonstrated by joint diagrams.

The most important deformations within a joint are elastic bolt elongation and elastic joint compression in the axial direction. If the bolted joint in Fig. 1 is subjected to the preload F_i the bolt elongates as shown by the line OB in Fig. 2A and the joint compresses as shown by the line OJ. These two lines, representing the spring characteristics of the bolt and joint, are combined into one diagram in Fig. 2B to show total elastic deformation.

If a concentric external load F_e is applied under the bolt head and nut in Fig. 1, the bolt elongates an additional amount while the compressed joint members partially relax. These changes in deformation with external loading are the key to the interaction of forces in bolted joints.

In Fig. 3A the external load F_e is added to the joint diagram F_e is located on the diagram by applying the upper end to an extension of OB and moving it in until the lower end contacts OJ. Since the total amount of elastic deformation (bolt plus joint) remains constant for a given preload, the external load changes the total bolt elongation to $\Delta l_b + \lambda$ and the total joint compression to $\Delta l_j - \lambda$.

In Fig. 3B the external load F_e is divided into an additional bolt load F_{eB} and the joint load F_{eJ} , which unloads the compressed joint members. The maximum bolt load is the sum of the load preload and the additional bolt load:

$$F_{B \max} = F_i + F_{eB}$$

If the external load F_e is an alternating load, F_{eB} is that part of F_e working as an alternating bolt load, as shown in Fig. 3B. This joint diagram also illustrates that the joint absorbs more of the external load than the bolt subjected to an alternating external load.

The importance of adequate preload is shown in Fig. 3C. Comparing Fig. 3B and Fig. 3C, it can be seen that F_{eB} will remain relatively small as long as the preload F_i is greater than F_{eJ} . Fig. 3C represents a joint with insufficient preload. Under this condition, the amount of external load that the joint can absorb is limited, and the excess load

must then be applied to the bolt. If the external load is alternating, the increased stress levels on the bolt produce a greatly shortened fatigue life.

When seating requires a certain minimum force or when transverse loads are to be transformed by friction, the minimum clamping load $F_{J \min}$ is important.

$$F_{J \min} = F_{B \max} - F_e$$

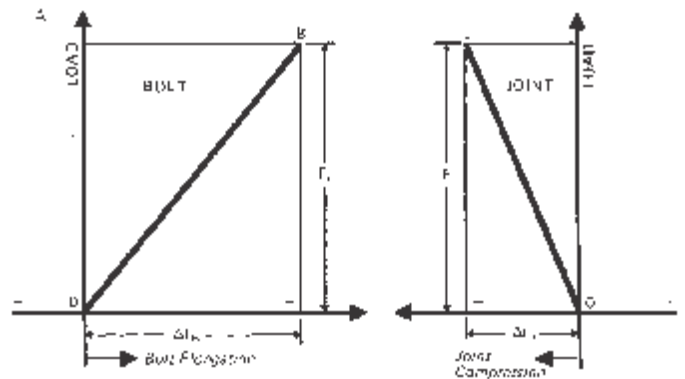

Fig. 1 (above) Joint components

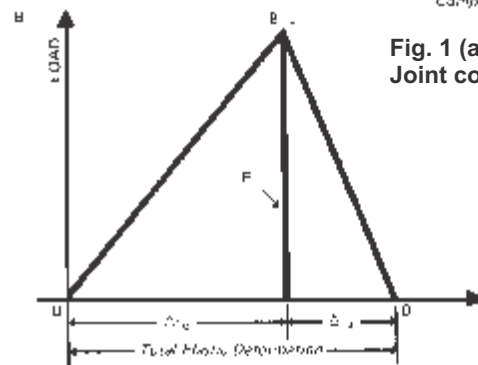

Fig. 2 Joint diagram is obtained by combining load vs. deformation diagrams of bolt and joints.

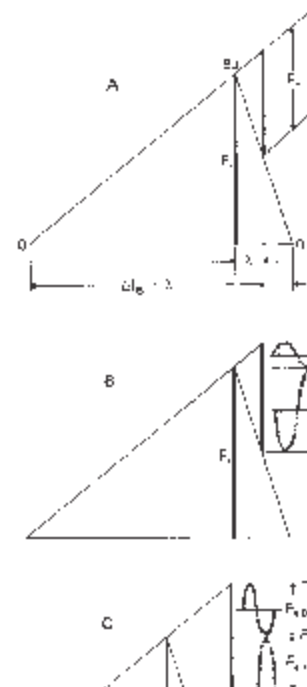

Fig. 3 The complete simple joint diagrams show external load F_e added (A), and external load divided into an additional bolt load F_{eB} and reduction in joint compression F_{eJ} (B). Joint diagram (C) shows how insufficient preload F_i causes excessive additional bolt load F_{eB}

Spring Constants

To construct a joint diagram, it is necessary to determine the spring rates of both bolt and joint. In general, spring rate is defined as:

$$K = \frac{F}{\Delta l}$$

From Hook's law:

$$\Delta l = \frac{lF}{EA}$$

Therefore:

$$K = \frac{EA}{l}$$

To calculate the spring rate of bolts with different cross sections, the reciprocal spring rates, or compliances, of each section are added:

$$\frac{1}{K_B} = \frac{1}{K_1} + \frac{1}{K_2} + \dots + \frac{1}{K_n}$$

Thus, for the bolt shown in Fig. 4:

$$\frac{1}{K_B} = \frac{1}{E} \left(\frac{0.4d}{A_1} + \frac{l_1}{A_1} + \frac{l_2}{A_2} + \frac{l_3}{A_m} + \frac{0.4d}{A_m} \right)$$

where

d = the minor thread diameter and

A_m = the area of the minor thread diameter

This formula considers the elastic deformation of the head and the engaged thread with a length of $0.4d$ each.

Calculation of the spring rate of the compressed joint members is more difficult because it is not always obvious which parts of the joint are deformed and which are not. In general, the spring rate of a clamped part is:

$$K_J = \frac{EA_s}{l_j}$$

where A_s is the area of a substitute cylinder to be determined.

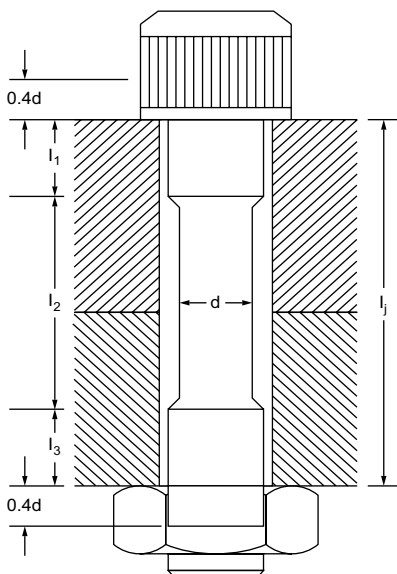

Fig. 4 Analysis of bolt lengths contributing to the bolt spring rate.

When the outside diameter of the joint is smaller than or equal to the bolt head diameter, i.e., as in a thin bushing, the normal cross sectioned area is computed:

$$A_s = \frac{\pi}{4} (D_c^2 - D_h^2)$$

where

D_c = OD of cylinder or bushing and

D_h = hole diameter

When the outside diameter of the joint is larger than head or washer diameter D_H , the stress distribution is in the shape of a barrel, Fig 5. A series of investigations proved that the areas of the following substitute cylinders are close approximations for calculating the spring contents of concentrically loaded joints.

When the joint diameter D_J is greater than D_H but less than $3D_H$;

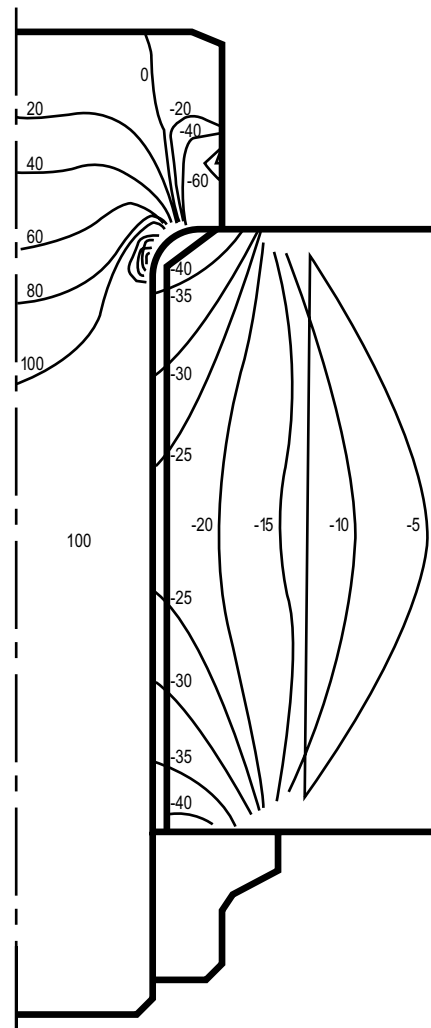

Fig. 5 Lines of equal axial stresses in a bolted joint obtained by the axisymmetric finite element method are shown for a 9/16—18 bolt preloaded to 100 KSI. Positive numbers are tensile stresses in KSI; negative numbers are compressive stresses in KSI.

$$A_s = \frac{\pi}{4} (D_H^2 - D_n^2) + \frac{\pi}{8} \left(\frac{D_J}{D_H} - 1 \right) \left(\frac{D_H l_J}{5} + \frac{l_J^2}{100} \right)$$

When the joint diameter D_J is equal to or greater than $3D_H$:

$$A_s = \frac{\pi}{4} [(D_H + 0.1 l_J)^2 - D_n^2]$$

These formulate have been verified in laboratories by finite element method and by experiments.

Fig. 6 shows joint diagrams for springy bolt and stiff joint and for a stiff bolt and springy joint. These diagrams demonstrate the desirability of designing with springy bolt and a stiff joint to obtain a low additional bolt load F_{eB} and thus a low alternating stress.

The Force Ratio

Due to the geometry of the joint diagram, Fig. 7,

$$F_{eB} = \frac{K_e K_B}{K_B + K_J}$$

$$\text{Defining } \Phi = \frac{K_B}{K_B + K_J}$$

$$F_{eB} = F_e \Phi \text{ and } \Phi, \text{ called the Force Ratio,} = \frac{F_{eB}}{F_e}$$

For complete derivation of Φ see Fig. 7.

To assure adequate fatigue strength of the selected fastener the fatigue stress amplitude of the bolt resulting from an external load F_e is computed as follows:

$$\sigma_B = \pm \frac{F_{eB}/2}{A_m} \text{ or}$$

$$\sigma_B = \pm \frac{\Phi F_e}{2 A_m}$$

Effect of Loading Planes

The joint diagram in Fig 3, 6 and 7 is applicable only when the external load F_e is applied at the same loading planes as the preloaded F_i , under the bolt head and the nut. However, this is a rare case, because the external load usually affects the joint somewhere between the center of the joint and the head and the nut.

When a preloaded joint is subjected to an external load F_e at loading planes 2 and 3 in Fig. 8, F_e relieves the compression load of the joint parts between planes 2 and 3. The remainder of the system, the bolt and the joint parts between planes 1-2 and 3-4, feel additional load due to F_e applied planes 2 and 3, the joint material between planes 2 and 3 is the clamped part and all other joint members, fastener and remaining joint material, are clamping parts. Because of the location of the loading planes, the joint diagram changes from black line to the blue line. Consequently, both the additional bolt load $F_{B \max}$ decrease significantly when the loading planes of F_e shift from under the bolt head and nut toward the joint center.

Determination of the length of the clamped parts is, however, not that simple. First, it is assumed that the external load is applied at a plane perpendicular to the bolt axis. Second, the distance of the loading planes from each other has to be estimated. This distance may be expressed as the ratio of the length of clamped parts to the total joint length. Fig. 9 shows the effect of two different loading planes on the bolt load, both joints having the same preload F_i and the same external load F_e . The lengths of the clamped parts are estimated to be $0.75/l_J$ for joint A, and $0.25/l_J$ for joint B.

In general, the external bolt load is somewhere between $F_{eB} = 1\Phi F_e$ for loading planes under head and nut and $F_{eB} = 0\Phi F_e = 0$ when loading planes are in the joint center, as shown in Fig. 10. To consider the loading planes in calculation, the formula:

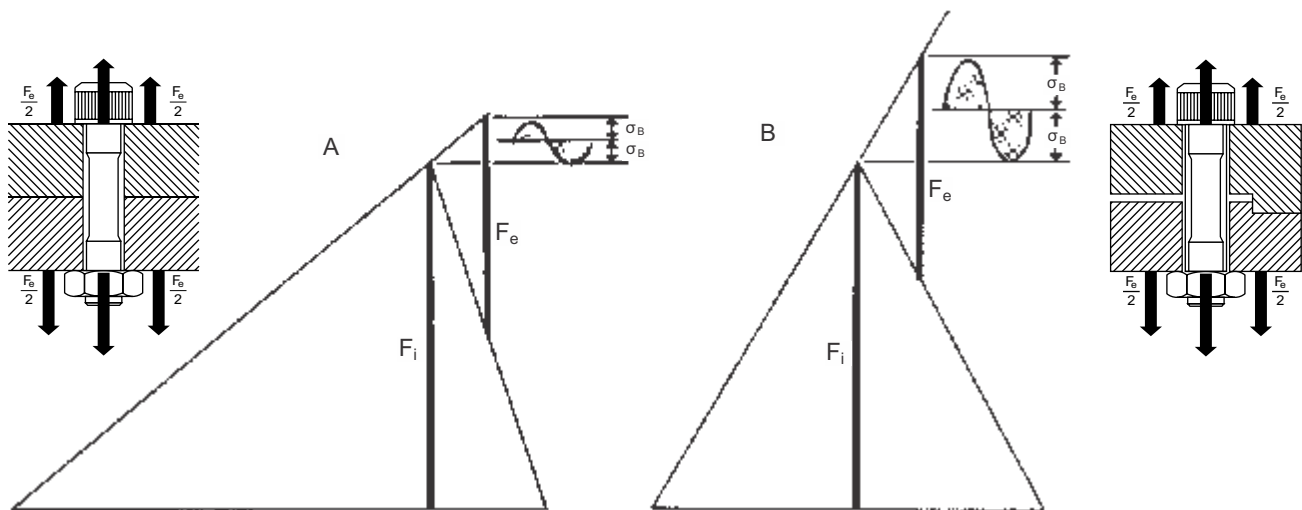

Fig. 6 Joint diagram of a springy bolt in a stiff joint (A), is compared to a diagram of a stiff bolt in a springy joint (B). Preload F_i and external load F_e are the same but diagrams show that alternating bolt stresses are significantly lower with a springy bolt in a stiff joint.

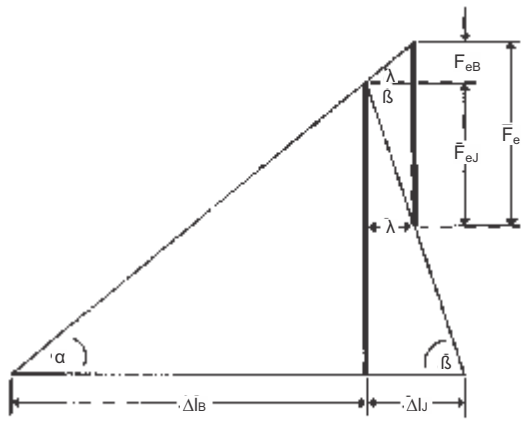

Fig. 7 Analysis of external load F_e and derivation of Force Ratio Φ .

$$\tan \alpha = \frac{F_i}{\Delta l_B} = K_B \text{ and } \tan \beta = \frac{F_j}{\Delta l_J} = K_J$$

$$\lambda = \frac{F_{eB}}{\tan \alpha} = \frac{F_{eJ}}{\tan \beta} = \frac{F_{eB}}{K_B} = \frac{F_{eJ}}{K_J} \text{ or}$$

$$F_{eJ} = \lambda \tan \beta \text{ and } F_{eB} = \lambda \tan \alpha$$

$$\text{Since } F_e = F_{eB} + F_{eJ} \\ F_e = F_{eB} + \lambda \tan \beta$$

Substituting $\frac{F_{eB}}{\tan \alpha}$ for λ produces:

$$F_e = F_{eB} + \frac{F_{eB} \tan \beta}{\tan \alpha}$$

Multiplying both sides by $\tan \alpha$:

$$F_e \tan \alpha = F_{eB} (\tan \alpha + \tan \beta) \text{ and}$$

$$F_{eB} = \frac{F_e \tan \alpha}{\tan \alpha + \tan \beta}$$

Substituting K_B for $\tan \alpha$ and K_J for $\tan \beta$

$$F_{eB} = F_e \frac{K_B}{K_B + K_J}$$

$$\text{Defining } \Phi = \frac{K_B}{K_B + K_J}$$

$$F_{eB} = \Phi F_e$$

$$\Phi = \frac{F_{eB}}{F_e} \text{ and it becomes obvious why } \Phi \text{ is called force ratio.}$$

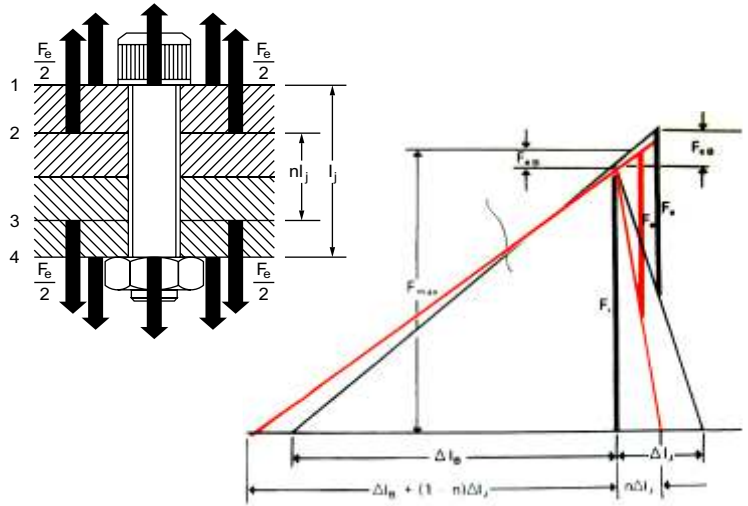

Fig. 8 Joint diagram shows effect of loading planes of F_e on bolt loads F_{eB} and $F_{B \max}$. Black diagram shows F_{eB} and $F_{B \max}$ resulting from F_e applied in planes 1 and 4. Orange diagram shows reduced bolt loads when F_e is applied in planes 2 and 3.

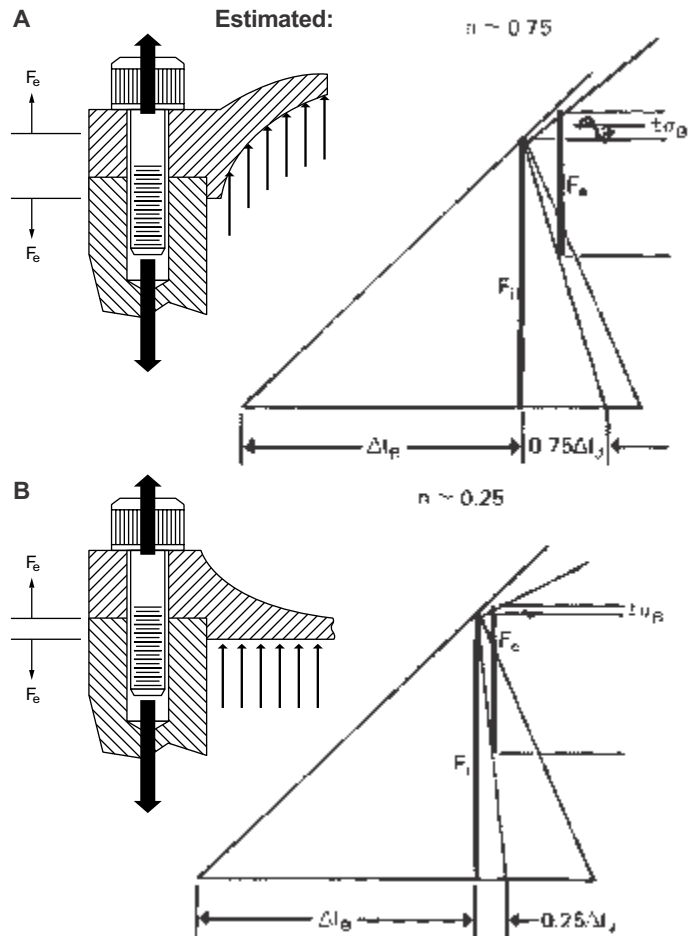

Fig. 9 When external load is applied relatively near bolt head, joint diagram shows resulting alternating stress α_B (A). When same value external load is applied relatively near joint center, lower alternating stress results (B).

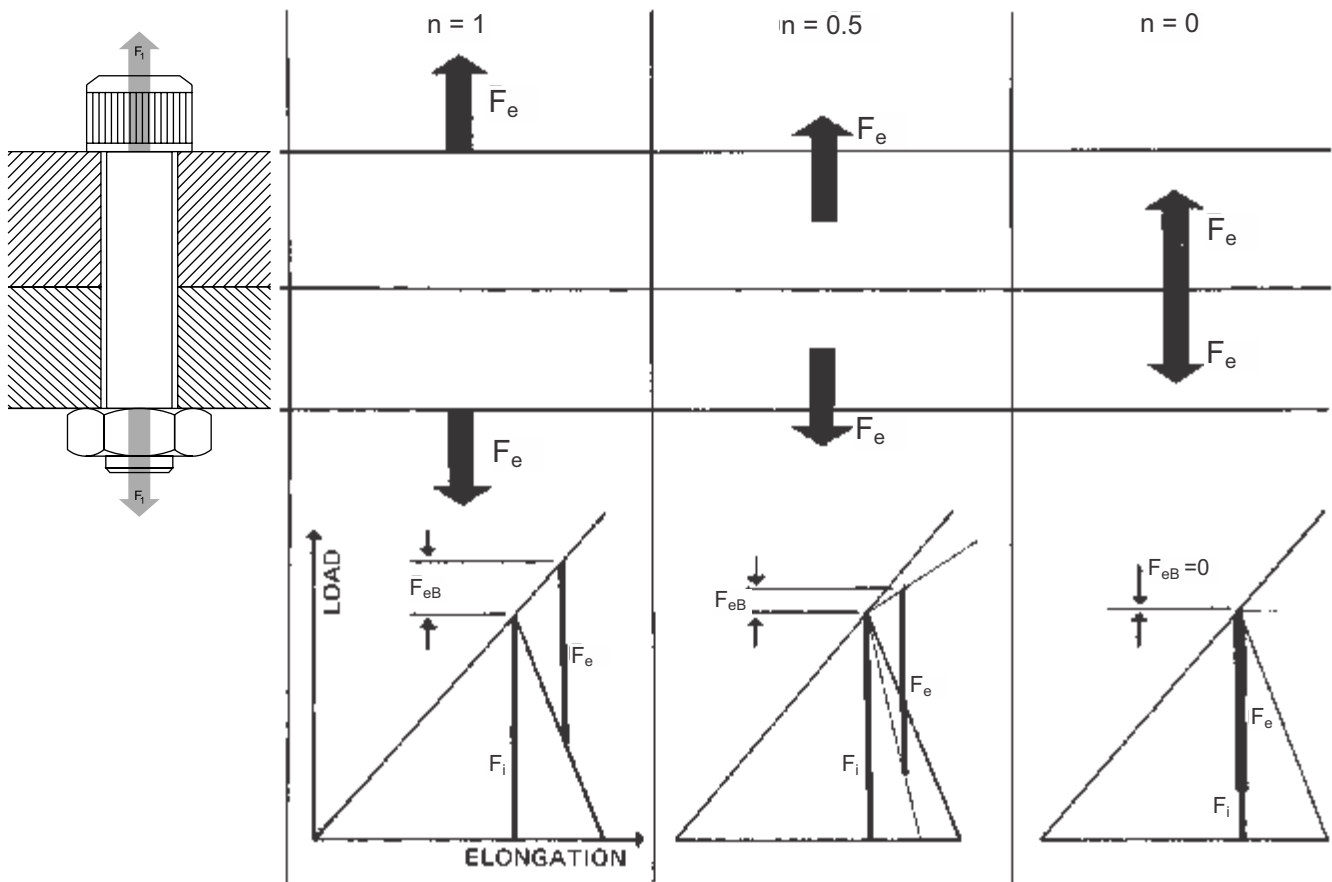

Fig. 10 Force diagrams show the effect of the loading planes of the external load on the bolt load.

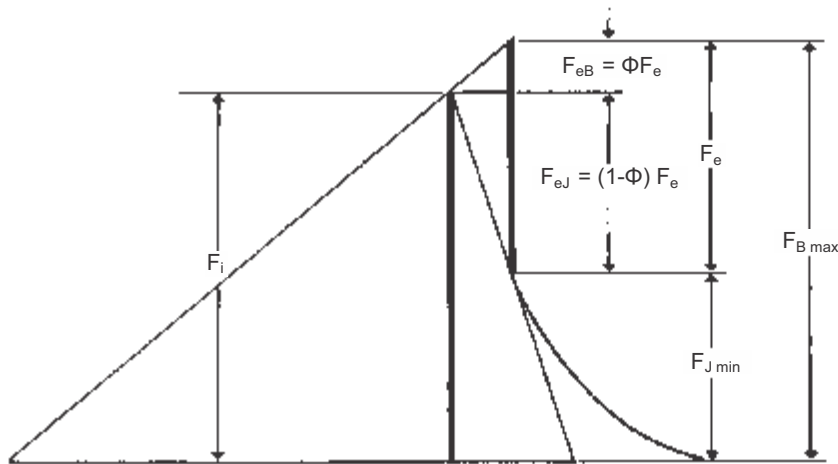

Fig. 11 Modified joint diagram shows nonlinear compression of joint at low preloads.

$F_{eB} = \Phi F_e$ must be modified to :

$$F_{eB} = n \Phi F_e$$

where n equals the ratio of the length of the clamped parts due to F_e to the joint length l_j . The value of n can range from 1, when F_e is applied under the head and nut, to 0, when F_e is applied at the joint center. Consequently the stress amplitude:

$$\sigma_B = \pm \frac{\Phi F_e}{2 A_m} \quad \text{becomes}$$

$$\sigma_B = \pm \frac{n \Phi F_e}{2 A_m}$$

General Design Formulae

Hitherto, construction of the joint diagram has assumed linear resilience of both bolt and joint members. However, recent investigations have shown that this assumption is not quite true for compressed parts.

Taking these investigations into account, the joint diagram is modified to Fig. 11. The lower portion of the joint spring rate is nonlinear, and the length of the linear portion depends on the preload level F_i . The higher F_i the longer the linear portion. By choosing a sufficiently high minimum load, $F_{i \min} > 2F_e$, the non-linear range of the joint spring rate is avoided and a linear relationship between F_{eB} and F_e is maintained.

Also from Fig. 11 this formula is derived:

$$F_{i \min} = F_{j \min} + (1 - \Phi) F_e + \Delta F_i$$

where ΔF_i is the amount of preload loss to be expected. For a properly designed joint, a preload loss $\Delta F_i = - (0.005 \text{ to } 0.10) F_i$ should be expected.

The fluctuation in bolt load that results from tightening is expressed by the ratio:

$$a = \frac{F_{i \max}}{F_{i \min}}$$

where a varies between 1.25 and 3.0 depending on the tightening method.

Considering the general design formulae are:

$$F_{i \text{ nom}} = F_{j \text{ min}} = (1 - \Phi) F_e$$

$$F_{i \text{ max}} = a [F_{j \text{ min}} + (1 - \Phi) F_e + \Delta F_i]$$

$$F_{B \text{ max}} = a [F_{j \text{ min}} + (1 - \Phi) F_e + \Delta F_i] + \Phi F_e$$

Conclusion

The three requirements of concentrically loaded joints that must be met for an integral bolted joint are:

1. The maximum bolt load $F_B \text{ max}$ must be less than the bolt yield strength.
2. If the external load is alternating, the alternating stress must be less than the bolt endurance limit to avoid fatigue failures.
3. The joint will not lose any preload due to permanent set or vibration greater than the value assumed for ΔF_i .

SYMBOLS

A	Area (in. ²)	$F_{B \text{ max}}$	Maximum Bolt load (lb)
A_m	Area of minor thread diameter (in. ²)	$F_{j \text{ min}}$	Minimum Joint load (lb)
A_s	Area of substitute cylinder (in. ²)	K	Spring rate (lb/in.)
A_x	Area of bolt part 1 _x (in. ²)	K_B	Spring rate of Bolt (lb/in.)
d	Diameter of minor thread (in.)	K_J	Spring rate of Joint (lb/in.)
D_c	Outside diameter of bushing (cylinder) (in.)	K_x	Spring rate of Bolt part 1 _x (lb/in.)
D_H	Diameter of Bolt head (in.)	l	Length (in.)
D_h	Diameter of hole (in.)	Δl	Change in length (in.)
D_J	Diameter of Joint	l_B	Length of Bolt (in.)
E	Modulus of Elasticity (psi)	Δl_B	Bolt elongation due to F_i (in.)
F	Load (lb)	l_J	Length of Joint (in.)
F_e	External load (lb.)	Δl_J	Joint compression to F_i (in.)
F_{eB}	Additional Bolt Load due to external load (lb)	l_x	Length of Bolt part x (in.)
F_{eJ}	Reduced Joint load due to external load (lb)	n	$\frac{\text{Length of clamped parts}}{\text{Total Joint Length}}$
F_i	Preload on Bolt and Joint (lb)	α	Tightening factor
ΔF_i	Preload loss (-lb)	Φ	Force ratio
$F_{i \text{ min}}$	Minimum preload (lb)	λ	Bolt and Joint elongation due to F_e (in.)
$F_{i \text{ max}}$	Maximum preload (lb)	σ_B	Bolt stress amplitude (\pm psi)
$F_{j \text{ nom}}$	Nominal preload (lb)		

TIGHTENING TORQUES AND THE TORQUE-TENSION RELATIONSHIP

All of the analysis and design work done in advance will have little meaning if the proper preload is not achieved. Several discussions in this technical section stress the importance of preload to maintaining joint integrity. There are many methods for measuring preload (see Table 12). However, one of the least expensive techniques that provides a reasonable level of accuracy versus cost is by measuring torque. The fundamental characteristic required is to know the relationship between torque and tension for any particular bolted joint. Once the desired design preload must be identified and specified first, then the torque required to induce that preload is determined.

Within the elastic range, before permanent stretch is induced, the relationship between torque and tension is essentially linear (see figure 13). Some studies have found up to 75 variables have an effect on this relationship: materials, temperature, rate of installation, thread helix angle, coefficients of friction, etc. One way that has been developed to reduce the complexity is to depend on empirical test results. That is, to perform experiments under the application conditions by measuring the induced torque and recording the resulting tension. This can be done with relatively simple, calibrated hydraulic pressure sensors, electric strain gages, or piezoelectric load cells. Once the data is gathered and plotted on a chart, the slope of the curve can be used to calculate a correlation factor. This technique has created an accepted formula for relating torque to tension.

$$T = K \times D \times P$$

T = torque, lbf.-in.

D = fastener nominal diameter, inches

P = preload, lbf.

K = "nut factor," "tightening factor," or "k-value"

If the preload and fastener diameter are selected in the design process, and the K-value for the application conditions is known, then the necessary torque can be calculated. It is noted that even with a specified torque, actual conditions at the time of installation can result in variations in the actual preload achieved (see Table 12).

One of the most critical criteria is the selection of the K-value. Accepted nominal values for many industrial applications are:

K = 0.20 for as-received steel bolts into steel holes

K = 0.15 steel bolts with cadmium plating, which acts like a lubricant,

K = 0.28 steel bolts with zinc plating.

The K-value is not the coefficient of the friction (μ); it is an empirically derived correlation factor.

It is readily apparent that if the torque intended for a zinc plated fastener is used for cadmium plated fastener, the preload will be almost two times that intended; it may actually cause the bolt to break.

Another influence is where friction occurs. For steel bolts holes, approximately 50% of the installation torque is consumed by friction under the head, 35% by thread friction, and only the remaining 15% inducing preload tension. Therefore, if lubricant is applied just on the

fastener underhead, full friction reduction will not be achieved. Similarly, if the material against which the fastener is bearing, e.g. aluminum, is different than the internal thread material, e.g. cast iron, the effective friction may be difficult to predict. These examples illustrate the importance and the value of identifying the torque-tension relationship. It is a recommend practice too contact the lubricant manufacturer for K-value information if a lubricant will be used.

The recommended seating torques for Unbrako headed socket screws are based on inducing preloads reasonably expected in practice for each type. The values for Unbrako metric fasteners are calculated using VDI2230, a complex method utilized extensively in Europe. All values assume use in the received condition in steel holes. It is understandable the designer may need preloads higher than those listed. The following discussion is presented for those cases.

TORSION-TENSION YIELD AND TENSION CAPABILITY AFTER TORQUING

Once a headed fastener has been seated against a bearing surface, the inducement of torque will be translated into both torsion and tension stresses. These stresses combine to induce twist. If torque continues to be induced, the stress along the angle of twist will be the largest stress *while the bolt is being torqued*. Consequently, the stress along the bolt axis (axial tension) will be something less. This is why a bolt can fail at a lower tensile stress *during installation* than when it is pulled in straight tension alone, eg. a tensile test. Research has indicated the axial tension can range from 135,000 to 145,000 PSI for industry socket head cap screws at torsion-tension yield, depending on diameter. Including the preload variation that can occur with various installation techniques, eg. up to 25%, it can be understood why some recommended torques induce preload reasonably lower than the yield point.

Figure 13 also illustrates the effect of straight tension applied after installation has stopped. Immediately after stopping the installation procedure there will be some relaxation, and the torsion component will drop toward zero. This leaves only the axial tension, which keeps the joint clamped together. Once the torsion is relieved, the axial tension yield value and ultimate value for the fastener will be appropriate.

Table 12
Industrial Fasteners Institute's
Torque-Measuring Method

Preload Measuring Method	Accuracy Percent	Relative Cost
Feel (operator's judgement)	±35	1
Torque wrench	±25	1.5
Turn of the nut	±15	3
Load-indicating washers	±10	7
Fastener elongation	±3 to 5	15
Strain gages	±1	20

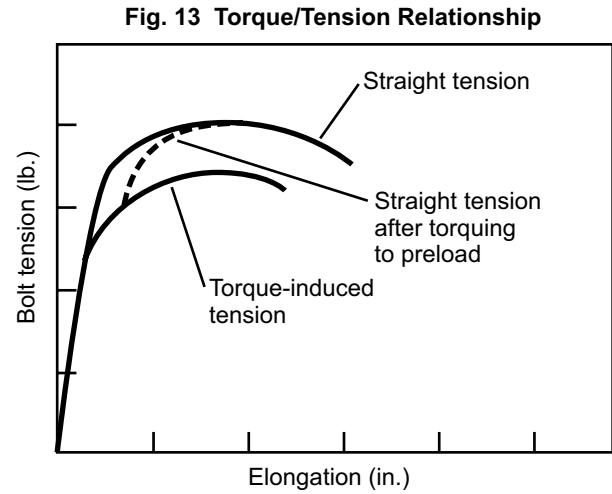
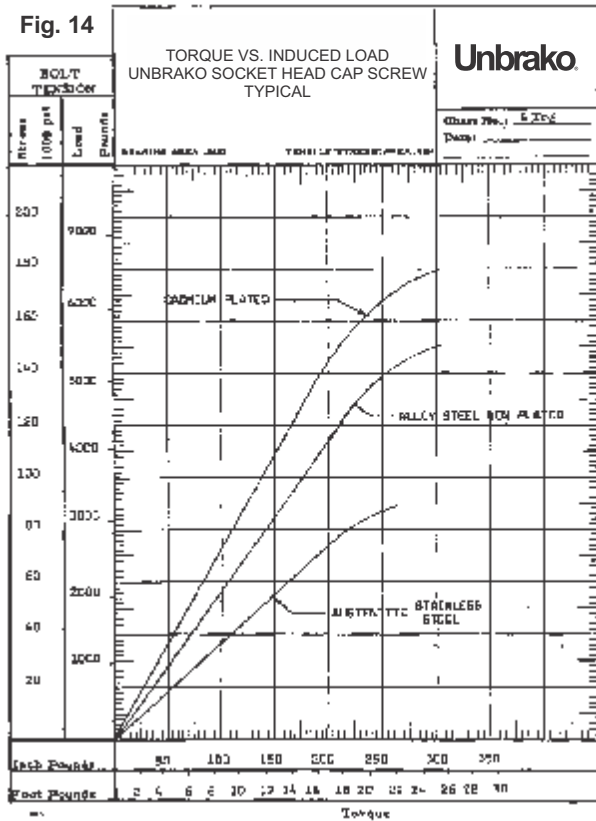

Fig. 15 Recommended Seating Torques (Inch-Lb.) for Application in Various Materials UNBRAKO pHd (1960 Series) Socket Head Cap Screws

screw size	mild steel Rb 87 cast iron Rb 83 note 1		brass Rb 72 note 2		aluminum Rb 72 (2024-T4) note 3	
	UNC	UNF	UNC	UNF	UNC	UNF
	plain	plain	plain	plain	plain	plain
#0	—	*2.1	—	*2.1	—	*2.1
#1	*3.8	*4.1	*3.8	*4.1	*3.8	*4.1
#2	*6.3	*6.8	*6.3	*6.8	*6.3	*6.8
#3	*9.6	*10.3	*9.6	*10.3	*9.6	*10.3
#4	*13.5	*14.8	*13.5	*14.8	*13.5	*14.8
#5	*20	*21	*20	*21	*20	*21
#6	*25	*28	*25	*28	*25	*28
#8	*46	*48	*46	*48	*46	*48
#10	*67	*76	*67	*76	*67	*76
1/4	*158	*180	136	136	113	113
5/16	*326	*360	228	228	190	190
3/8	*580	635	476	476	397	397
7/16	*930	*1,040	680	680	570	570
1/2	*1,420	*1,590	1,230	1,230	1,030	1,030
9/16	*2,040	2,250	1,690	1,690	1,410	1,410
5/8	*2,820	3,120	2,340	2,340	1,950	1,950
3/4	*5,000	5,340	4,000	4,000	3,340	3,340
7/8	*8,060	8,370	6,280	6,280	5,230	5,230
1	*12,100	12,800	9,600	9,600	8,000	8,000
1 1/8	*13,800	*15,400	13,700	13,700	11,400	11,400
1 1/4	*19,200	*21,600	18,900	18,900	15,800	15,800
1 3/8	*25,200	*28,800	24,200	24,200	20,100	20,100
1 1/2	*33,600	*36,100	32,900	32,900	27,400	27,400

NOTES:

1. Torques based on 80,000 psi bearing stress under head of screw.
2. Torques based on 60,000 psi bearing stress under head of screw.
3. Torques based on 50,000 psi bearing stress under head of screw.

*Denotes torques based on 100,000 psi tensile stress in screw threads up to 1" dia., and 80,000 psi for sizes 1 1/8" dia. and larger. To convert inch-pounds to inch-ounces — multiply by 16. To convert inch-pounds to foot-pounds — divide by 12.

STRIPPING STRENGTH OF TAPPED HOLES

Charts and sample problems for obtaining minimum thread engagement based on applied load, material, type of thread and bolt diameter.

Knowledge of the thread stripping strength of tapped holes is necessary to develop full tensile strength of the bolt or, for that matter, the minimum engagement needed for any lesser load.

Conversely, if only limited length of engagement is available, the data help determine the maximum load that can be safely applied without stripping the threads of the tapped hole.

Attempts to compute lengths of engagement and related factors by formula have not been entirely satisfactory—mainly because of subtle differences between various materials. Therefore, strength data has been empirically developed from a series of tensile tests of tapped specimens for seven commonly used metals including steel, aluminum, brass and cast iron.

The design data is summarized in the six accompanying charts, (Charts E504–E509), and covers a range of screw thread sizes from #0 to one inch in diameter for both coarse and fine threads. Though developed from tests of Unbrako socket head cap screws having minimum ultimate tensile strengths (depending on the diameter) from 190,000 to 180,000 psi, these stripping strength values are valid for all other screws or bolts of equal or lower strength having a standard thread form. Data are based on static loading only.

In the test program, bolts threaded into tapped specimens of the metal under study were stressed in tension until the threads stripped. Load at which stripping occurred and the length of engagement of the specimen were noted. Conditions of the tests, all of which are met in a majority of industrial bolt applications, were:

- Tapped holes had a basic thread depth within the range of 65 to 80 per cent. Threads of tapped holes were Class 2B fit or better.
- Minimum amount of metal surrounding the tapped hole was 2 1/2 times the major diameter.
- Test loads were applied slowly in tension to screws having standard Class 3A threads. (Data, though, will be equally applicable to Class 2A external threads as well.)
- Study of the test results revealed certain factors that greatly simplified the compilation of thread stripping strength data:
- Stripping strengths are almost identical for loads applied either by pure tension or by screw torsion. Thus data are equally valid for either condition of application.

- Stripping strength values vary with diameter of screw. For a given load and material, larger diameter bolts required greater engagement.
- Minimum length of engagement (as a percent of screw diameter) is a straight line function of load. This permits easy interpolation of test data for any intermediate load condition.
- When engagement is plotted as a percentage of bolt diameter, it is apparent that stripping strengths for a wide range of screw sizes are close enough to be grouped in a single curve. Thus, in the accompanying charts, data for sizes #0 through #12 have been represented by a single set of curves.

With these curves, it becomes a simple matter to determine stripping strengths and lengths of engagement for any condition of application. A few examples are given below:

Example 1. Calculate length of thread engagement necessary to develop the minimum ultimate tensile strength (190,000 psi) of a 1/2–13 (National Coarse) Unbrako cap screw in cast iron having an ultimate shear strength of 30,000 psi. E505 is for screw sizes from #0 through #10; E506 and E507 for sizes from 1/4 in. through 5/8 in.; E508 and E509 for sizes from 3/4 in. through 1 in. Using E506 a value 1.40D is obtained. Multiplying nominal bolt diameter (0.500 in.) by 1.40 gives a minimum length of engagement of 0.700 in.

Example 2. Calculate the length of engagement for the above conditions if only 140,000 psi is to be applied. (This is the same as using a bolt with a maximum tensile strength of 140,000psi.) From E506 obtain value of 1.06D. Minimum length of engagement = (0.500) (1.06) = 0.530.

Example 3. Suppose in Example 1 that minimum length of engagement to develop full tensile strength was not available because the thickness of metal allowed a tapped hole of only 0.600 in. Hole depth in terms of bolt dia. = $0.600/0.500 = 1.20D$. By working backwards in Fig. 2, maximum load that can be carried is approximately 159,000 psi.

Example 4. Suppose that the hole in Example 1 is to be tapped in steel having an ultimate shear strength 65,000 psi. There is no curve for this steel in E506 but a design value can be obtained by taking a point midway between curves for the 80,000 psi and 50,000 psi steels that are listed. Under the conditions of the example, a length of engagement of 0.825D or 0.413 in. will be obtained.

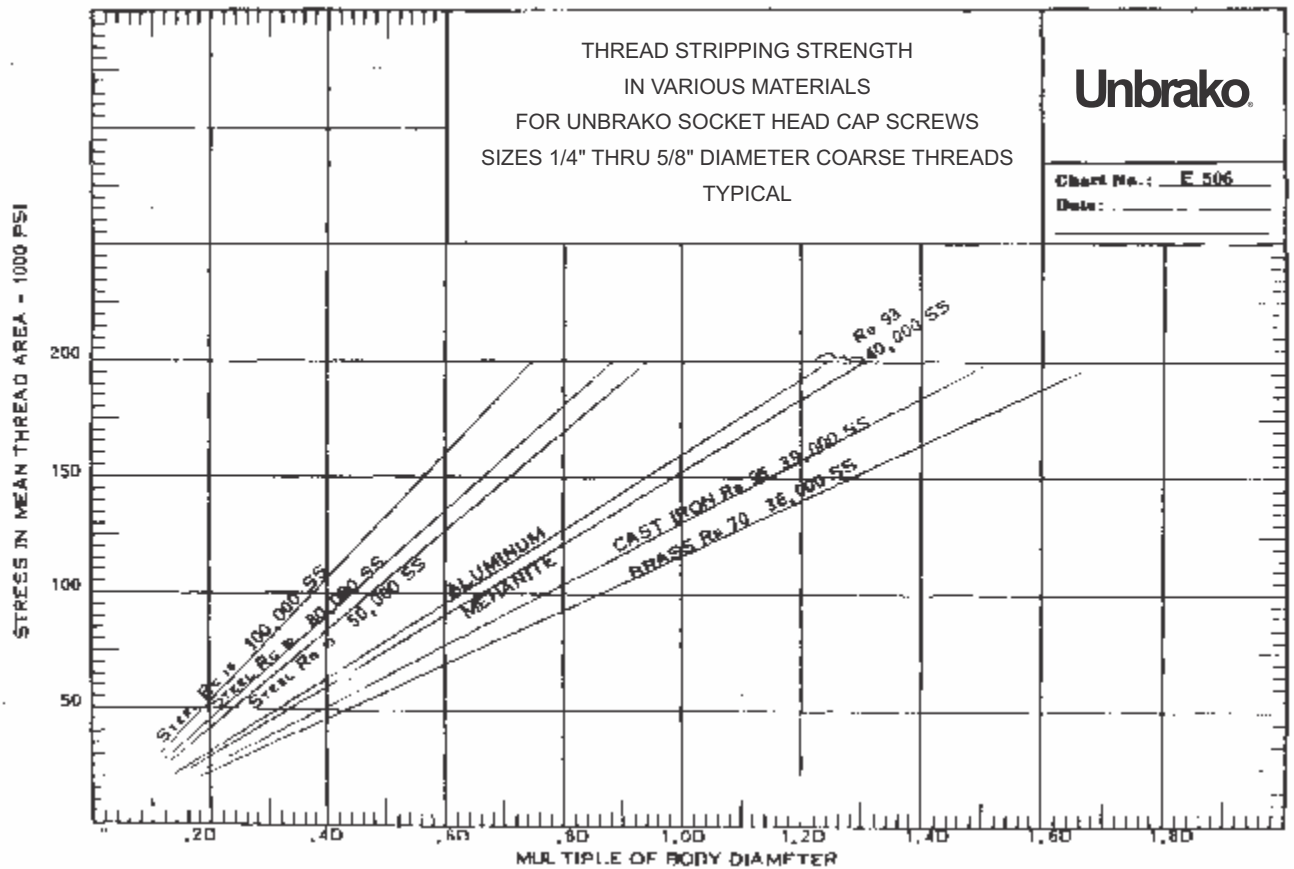
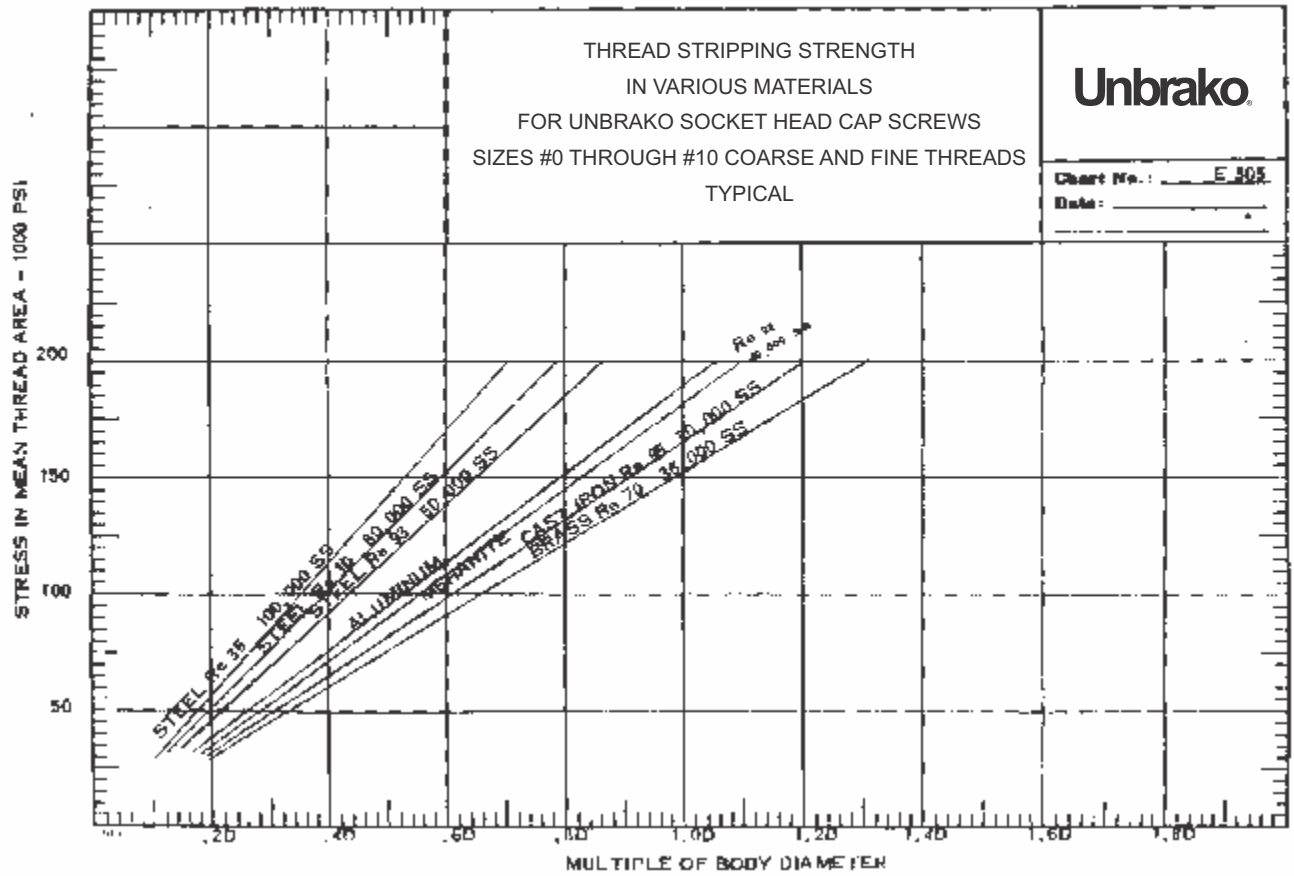

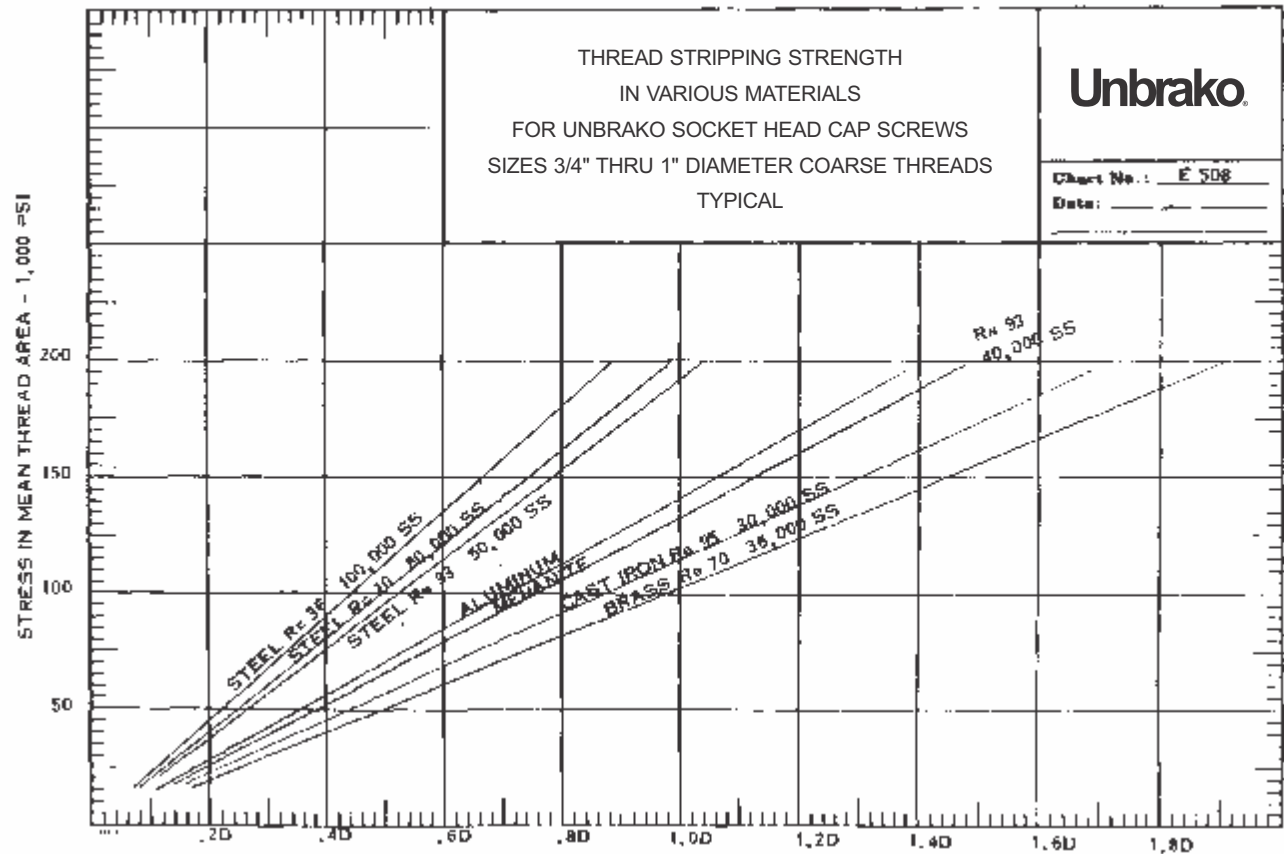
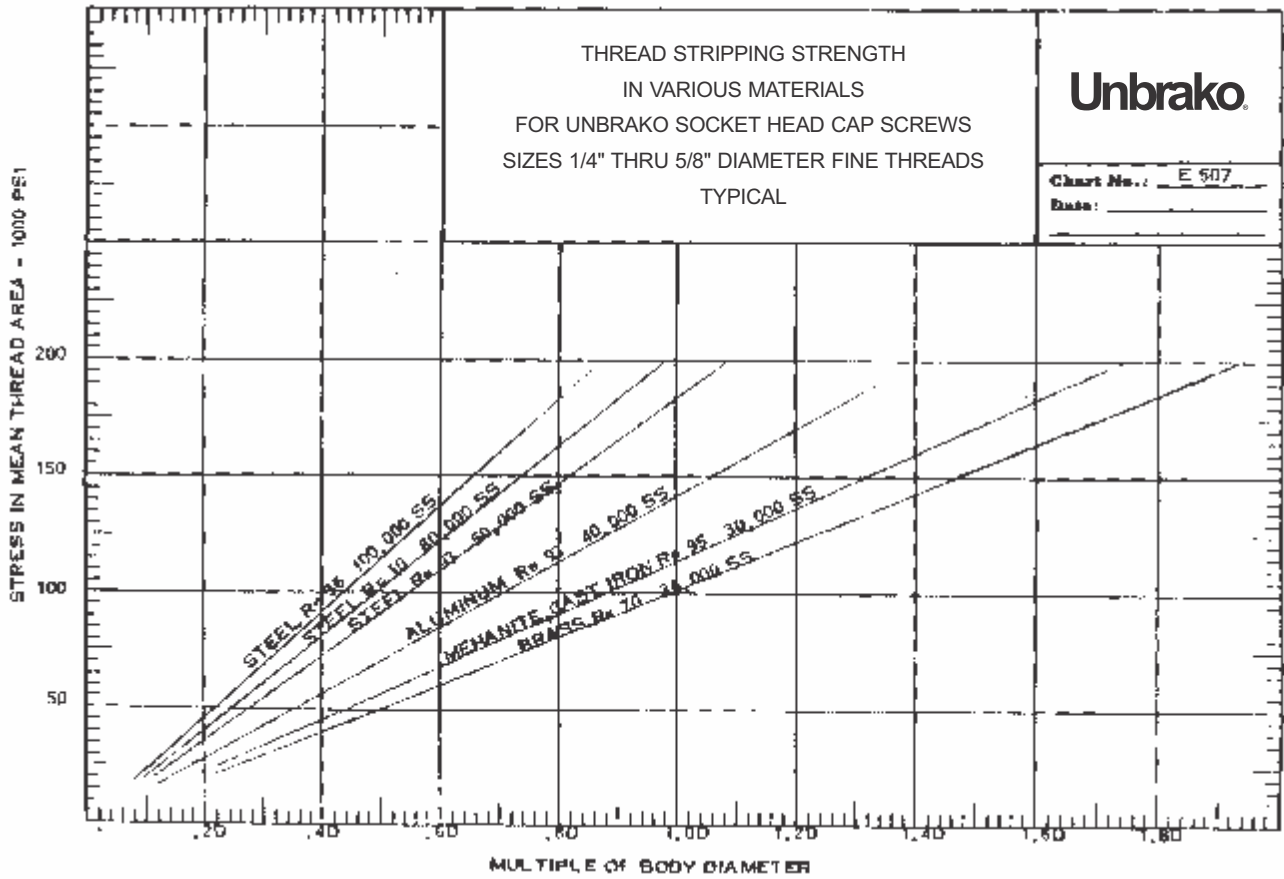

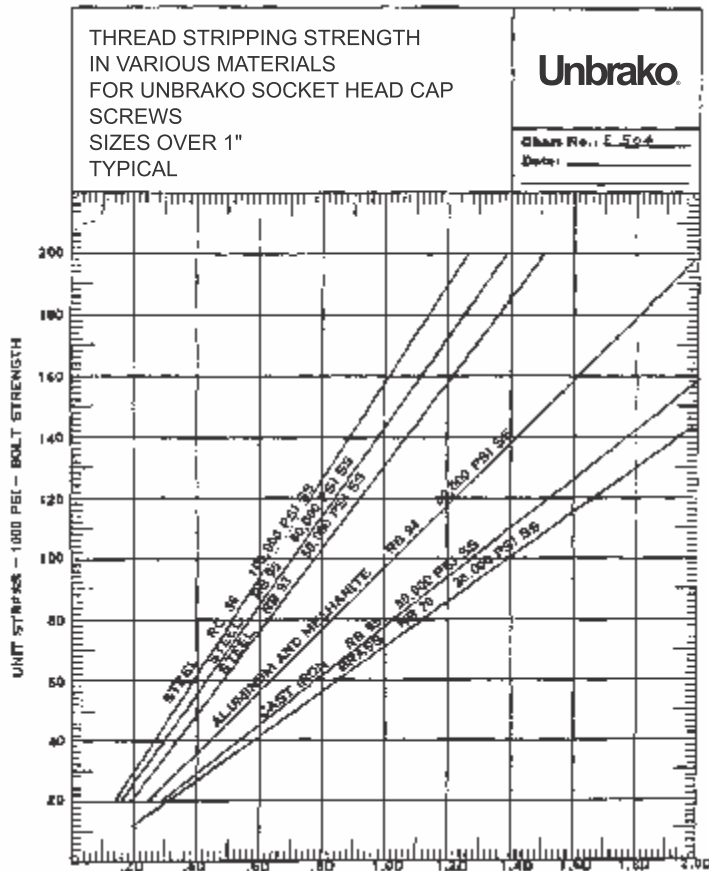
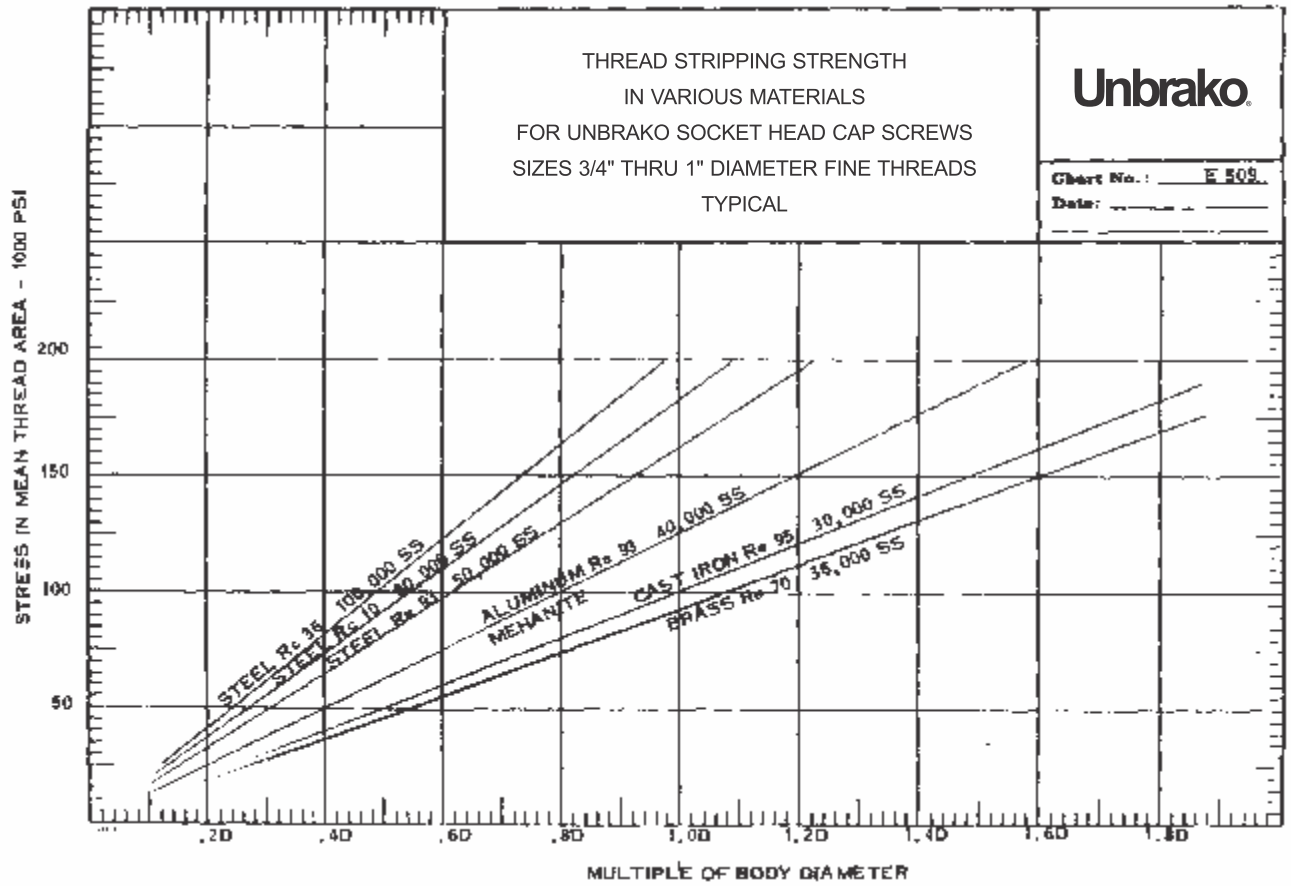

HIGH-TEMPERATURE JOINTS

Bolted joints subjected to cyclic loading perform best if an initial preload is applied. The induced stress minimizes the external load sensed by the bolt, and reduces the chance of fatigue failure. At high temperature, the induced load will change, and this can adversely affect the fastener performance. It is therefore necessary to compensate for high-temperature conditions when assembling the joint at room temperature. This article describes the factors which must be considered and illustrates how a high-temperature bolted joint is designed.

In high-temperature joints, adequate clamping force or preload must be maintained in spite of temperature-induced dimensional changes of the fastener relative to the joint members. The change in preload at any given temperature for a given time can be calculated, and the affect compensated for by proper fastener selection and initial preload.

Three principal factors tend to alter the initial clamping force in a joint at elevated temperatures, provided that the fastener material retains requisite strength at the elevated temperature. These factors are: Modulus of elasticity, coefficient of thermal expansion, and relaxation.

Modulus Of Elasticity: As temperature increases, less stress or load is needed to impart a given amount of elongation or strain to a material than at lower temperatures. This means that a fastener stretched a certain amount at room temperature to develop a given preload will exert a lower clamping force at higher temperature if there is no change in bolt elongation.

Coefficient of Expansion: With most materials, the size of the part increases as the temperature increases. In a joint, both the structure and the fastener grow with an increase in temperature, and this can result, depending on the materials, in an increase or decrease in the clamping force. Thus, matching of materials in joint design can assure sufficient clamping force at both room and elevated temperatures. Table 16 lists mean coefficient of thermal expansion of certain fastener alloys at several temperatures.

Relaxation: At elevated temperatures, a material subjected to constant stress below its yield strength will flow plastically and permanently change size. This phenomenon is called creep. In a joint at elevated temperature, a fastener with a fixed distance between the bearing surface of the head and nut will produce less and less clamping force with time. This characteristic is called relaxation. It differs from creep in that stress changes while elongation or strain remains constant. Such elements as material, temperature, initial stress, manufacturing method, and design affect the rate of relaxation.

Relaxation is the most important of the three factors. It is also the most critical consideration in design of elevated-temperature fasteners. A bolted joint at 1200°F can lose as much as 35 per cent of preload. Failure to compensate for this could lead to fatigue failure through a loose joint even though the bolt was properly tightened initially.

If the coefficient of expansion of the bolt is greater than that of the joined material, a predictable amount of clamping force will be lost as temperature increases. Conversely, if the coefficient of the joined material is greater, the bolt may be stressed beyond its yield or even fracture strength. Or, cyclic thermal stressing may lead to thermal fatigue failure.

Changes in the modulus of elasticity of metals with increasing temperature must be anticipated, calculated, and compensated for in joint design. Unlike the coefficient of expansion, the effect of change in modulus is to reduce clamping force whether or not bolt and structure are the same material, and is strictly a function of the bolt metal.

Since the temperature environment and the materials of the structure are normally "fixed," the design objective is to select a bolt material that will give the desired clamping force at all critical points in the operating range of the joint. To do this, it is necessary to balance out the three factors—relaxation, thermal expansion, and modulus—with a fourth, the amount of initial tightening or clamping force.

In actual joint design the determination of clamping force must be considered with other design factors such as ultimate tensile, shear, and fatigue strength of the fastener at elevated temperature. As temperature increases the inherent strength of the material decreases. Therefore, it is important to select a fastener material which has sufficient strength at maximum service temperature.

Example

The design approach to the problem of maintaining satisfactory elevated-temperature clamping force in a joint can be illustrated by an example. The example chosen is complex but typical. A cut-and-try process is used to select the right bolt material and size for a given design load under a fixed set of operating loads and environmental conditions, Fig.17.

The first step is to determine the change in thickness, Δt , of the structure from room to maximum operating temperature.

For the AISI 4340 material:

$$\Delta t_1 = t_1(T_2 - T_1)\alpha$$
$$\Delta t_1 = (0.05)(800 - 70)(7.4 \times 10^{-6})$$
$$\Delta t_1 = 0.002701 \text{ in.}$$

For the AMS 6304 material:

$$\Delta t_2 = (0.75)(800 - 70)(7.6 \times 10^{-6})$$
$$\Delta t_2 = 0.004161 \text{ in.}$$

The total increase in thickness for the joint members is 0.00686 in.

The total effective bolt length equals the total joint thickness plus one-third of the threads engaged by the nut. If it is assumed that the smallest diameter bolt should be used for weight saving, then a 1/4-in. bolt should be tried. Thread engagement is approximately one diameter, and the effective bolt length is:

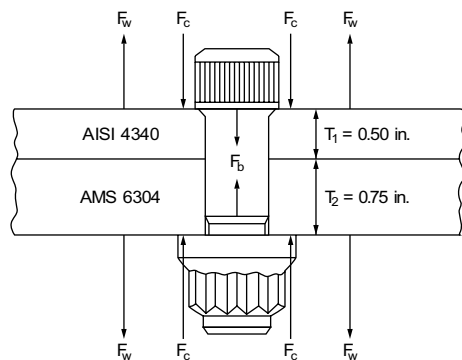

- d = Bolt diam, in.
- E = Modulus of elasticity, psi
- F_b = Bolt preload, lb
- F_c = Clamping force, lb
($F_b = F_c$)
- F_w = Working load=1500 lb
static + 100 lb cyclic
- L = Effective bolt length, inc.
- T_1 = Room temperature= 70°F
- T_2 = Maximum operating temperature for 1000 hr = 800°F
- t = Panel thickness, in.
- a = Coefficient of thermal expansion

Fig. 17 — Parameters for joint operating at 800°F.

$$L = t_1 + t_2 + (1/3 d)$$

$$L = 0.50 + 0.75 + (1/3 \times 0.25)$$

$$L = 1.333 \text{ in.}$$

The ideal coefficient of thermal expansion of the bolt material is found by dividing the total change in joint thickness by the bolt length times the change in temperature.

$$\alpha b = \frac{\Delta t}{L \times \Delta t}$$

$$\alpha = \frac{.00686}{(1.333)(800 - 70)} = 7.05 \times 10^{-6} \text{ in./in./deg. F}$$

The material, with the nearest coefficient of expansion is with a value of 9,600,000 at 800°F.

To determine if the bolt material has sufficient strength and resistance to fatigue, it is necessary to calculate the stress in the fastener at maximum and minimum load. The bolt load plus the cyclic load divided by the tensile stress of the threads will give the maximum stress. For a 1/4-28 bolt, tensile stress area, from thread handbook H 28, is 0.03637 sq. in. The maximum stress is

$$S_{max} = \frac{\text{Bolt load}}{\text{Stress area}} = \frac{1500 + 100}{0.03637}$$

$$S_{max} = 44,000 \text{ psi}$$

and the minimum bolt stress is 41,200 psi.

H-11 has a yield strength of 175,000 psi at 800°F, Table 3, and therefore should be adequate for the working loads.

A Goodman diagram, Fig. 18, shows the extremes of stress within which the H-11 fastener will not fail by fatigue. At the maximum calculated load of 44,000 psi, the fastener will withstand a minimum cyclic loading at 800°F of about 21,000 psi without fatigue failure.

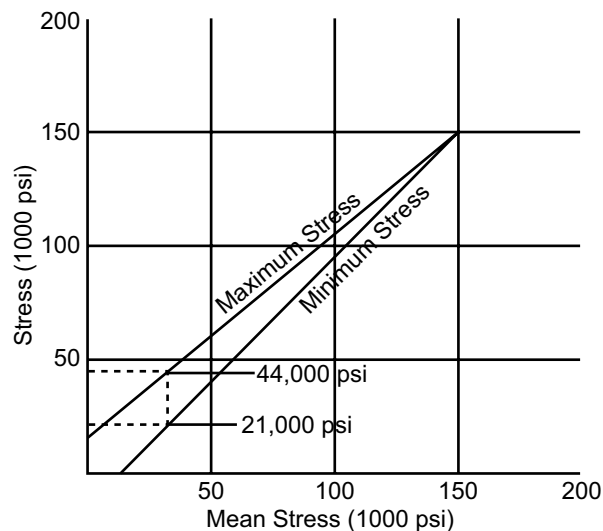

Fig. 18 — Goodman diagram of maximum and minimum operating limits for H-11 fastener at 800°F. Bolts stressed within these limits will give infinite fatigue life.

Because of relaxation, it is necessary to determine the initial preload required to insure 1500-lb. clamping force in the joint after 1000 hr at 800°F.

When relaxation is considered, it is necessary to calculate the maximum stress to which the fastener is subjected. Because this stress is not constant in dynamic joints, the resultant values tend to be conservative. Therefore, a maximum stress of 44,000 psi should be considered although the necessary stress at 800°F need be only 41,200 psi. Relaxation at 44,000 psi can be interpolated from the figure, although an actual curve could be constructed from tests made on the fastener at the specific conditions.

The initial stress required to insure a clamping stress of 44,000 psi after 1000 hr at 800°F can be calculated by interpolation.

$$x = 61,000 - 44,000 = 17,000$$

$$y = 61,000 - 34,000 = 27,000$$

$$B = 80,000 - 50,000 = 30,000$$

$$A = 80,000 - C$$

$$\frac{x}{y} = \frac{A}{B} \quad \frac{17,000}{27,000} = \frac{80,000 - C}{30,000}$$

$$C = 61,100 \text{ psi}$$

The bolt elongation required at this temperature is calculated by dividing the stress by the modulus at temperature and multiplying by the effective length of the bolt. That is: $(61,000 \times 1.333) / 24.6 \times 10^6 = 0.0033$

Since the joint must be constructed at room temperature, it is necessary to determine the stresses at this state. Because the modulus of the fastener material changes with temperature, the clamping force at room temperature will not be the same as at 800°F. To determine

the clamping stress at assembly conditions, the elongation should be multiplied by the modulus of elasticity at room temperature.

$$.0033 \times 30.6 \times 10^6 = 101,145 \text{ psi}$$

The assembly conditions will be affected by the difference between the ideal and actual coefficients of expansion of the joint. The ideal coefficient for the fastener material was calculated to be 7.05 but the closest material — H-11 — has a coefficient of 7.1. Since this material has a greater expansion than calculated, there will be a reduction in clamping force resulting from the increase in temperature. This amount equals the difference between the ideal and the actual coefficients multiplied by the change in temperature, the length of the fastener, and the modulus of elasticity at 70°F.

$$[(7.1 - 7.05) \times 10^6] [800 - 70] [1.333] \times [30.6 \times 10^3] = 1,490 \text{ psi}$$

The result must be added to the initial calculated stresses to establish the minimum required clamping stress needed for assembling the joint at room temperature.

$$101,145 + 1,490 = 102,635 \text{ psi}$$

Finally, the method of determining the clamping force or preload will affect the final stress in the joint at operating conditions. For example, if a torque wrench is used to

apply preload (the most common and simplest method available), a plus or minus 25 per cent variation in induced load can result. Therefore, the maximum load which could be expected in this case would be 1.5 times the minimum, or:

$$(1.5)(102,635) = 153,950 \text{ psi}$$

This value does not exceed the room-temperature yield strength for H-11 given in Table 19.

Since there is a decrease in the clamping force with an increase in temperature and since the stress at operating temperature can be higher than originally calculated because of variations in induced load, it is necessary to ascertain if yield strength at 800°F will be exceeded

$$\frac{(\text{max stress at } 70^\circ\text{F} + \text{change in stress}) \times E \text{ at } 800^\circ\text{F}}{E \text{ at } 70^\circ\text{F}} \\ \frac{[153,950 + (-1490)] \times 24.6 \times 10^6}{30.6 \times 10^6} = 122,565$$

This value is less than the yield strength for H-11 at 800°F, Table 19. Therefore, a 1/4-28 H-11 bolt stressed between 102,635 psi and 153,950 psi at room temperature will maintain a clamping load 1500 lb at 800°F after 1000 hr of operation. A cyclic loading of 100 lb, which results in a bolt loading between 1500 and 1600 lb will not cause fatigue failure at the operating conditions.

Table 16

PHYSICAL PROPERTIES OF MATERIALS USED TO MANUFACTURE ALLOY STEEL SHCS'S

Coefficient of Thermal Expansion, $\mu\text{m}/\text{m}/^\circ\text{K}^1$

20°C to 68°F to	100 212	200 392	300 572	400 752	500 932	600 1112
Material						
5137M, 51B37M ²	—	12.6	13.4	13.9	14.3	14.6
4137 ³	11.2	11.8	12.4	13.0	13.6	—
4140 ³	12.3	12.7	—	13.7	—	14.5
4340 ³	—	12.4	—	13.6	—	14.5
8735 ³	11.7	12.2	12.8	13.5	—	14.1
8740 ³	11.6	12.2	12.8	13.5	—	14.1

Modulus of Elongation (Young's Modulus)

E = 30,000,000 PSI/in/in

NOTES:

1. Developed from ASM, Metals HDBK, 9th Edition, Vol. 1 (°C = °K for values listed)
2. ASME SA574
3. AISI
4. Multiply values in table by .556 for $\mu\text{in}/\text{in}/^\circ\text{F}$.

Table 19 - Yield Strength at Various Temperatures

Alloy	Temperature (F)			
	70	800	1000	1200
Stainless Steels				
Type 302	35,000	35,000	34,000	30,000
Type 403	145,000	110,000	95,000	38,000
PH 15-7 Mo	220,000	149,000	101,000	—
High Strength Iron-Base Stainless Alloys				
A 286	95,000	95,000	90,000	85,000
AMS 5616	113,000	80,000	60,000	40,000
Unitemp 212	150,000	140,000	135,000	130,000
High Strength Iron-Base Alloys				
AISI 4340	200,000	130,000	75,000	—
H-11 (AMS 6485)	215,000	175,000	155,000	—
AMS 6340	160,000	100,000	75,000	—
Nickel-Base Alloys				
Inconel X	115,000	—	—	98,000
Waspaloy	115,000	—	106,000	100,000

All fastened joints are, to some extent, subjected to corrosion of some form during normal service life. Design of a joint to prevent premature failure due to corrosion must include considerations of the environment, conditions of loading, and the various methods of protecting the fastener and joint from corrosion.

Three ways to protect against corrosion are:

1. Select corrosion-resistant material for the fastener.
2. Specify protective coatings for fastener, joint interfaces, or both.
3. Design the joint to minimize corrosion.

The solution to a specific corrosion problem may require using one or all of these methods. Economics often necessitate a compromise solution.

Fastener Material

The use of a suitably corrosion-resistant material is often the first line of defense against corrosion. In fastener design, however, material choice may be only one of several important considerations. For example, the most corrosion-resistant material for a particular environment may just not make a suitable fastener.

Basic factors affecting the choice of corrosion resistant threaded fasteners are:

- Tensile and fatigue strength.
- Position on the galvanic series scale of the fastener and materials to be joined.
- Special design considerations: Need for minimum weight or the tendency for some materials to gall.
- Susceptibility of the fastener material to other types of less obvious corrosion. For example, a selected material may minimize direct attack of a corrosive environment only to be vulnerable to fretting or stress corrosion.

Some of the more widely used corrosion-resistant materials, along with approximate fastener tensile strength ratings at room temperature and other pertinent properties, are listed in Table 1. Sometimes the nature of corrosion properties provided by these fastener materials is subject to change with application and other condi-

tions. For example, stainless steel and aluminum resist corrosion only so long as their protective oxide film remains unbroken. Alloy steel is almost never used, even under mildly corrosive conditions, without some sort of protective coating. Of course, the presence of a specific corrosive medium requires a specific corrosion-resistant fastener material, provided that design factors such as tensile and fatigue strength can be satisfied.

Protective Coating

A number of factors influence the choice of a corrosion-resistant coating for a threaded fastener. Frequently, the corrosion resistance of the coating is not a principal consideration. At times it is a case of economics. Often, less-costly fastener material will perform satisfactorily in a corrosive environment if given the proper protective coating.

Factors which affect coating choice are:

- Corrosion resistance
- Temperature limitations
- Embrittlement of base metal
- Effect on fatigue life
- Effect on locking torque
- Compatibility with adjacent material
- Dimensional changes
- Thickness and distribution
- Adhesion characteristics

Conversion Coatings: Where cost is a factor and corrosion is not severe, certain conversion-type coatings are effective. These include a black-oxide finish for alloy-steel screws and various phosphate base coatings for carbon and alloy-steel fasteners. Frequently, a rust-preventing oil is applied over a conversion coating.

Paint: Because of its thickness, paint is normally not considered for protective coatings for mating threaded fasteners. However, it is sometimes applied as a supplemental treatment at installation. In special cases, a fastener may be painted and installed wet, or the entire joint may be sealed with a coat of paint after installation.

TABLE 1 — TYPICAL PROPERTIES OF CORROSION RESISTANT FASTENER MATERIALS

Materials Stainless Steel	Tensile Strength (1000 psi)	Yield Strength at 0.2% offset (1000 psi)	Maximum Service Temp (F)	Mean Coefficient of Thermal Expan. (in./in./deg F)	Density (lbs/cu in.)	Base Cost Index	Position on Galvanic Scale
303, passive	80	40	800	10.2	0.286	Medium	8
303, passive, cold worked	125	80	800	10.3	0.286	Medium	9
410, passive	170	110	400	5.6	0.278	Low	15
431, passive	180	140	400	6.7	0.280	Medium	16
17-4 PH	200	180	600	6.3	0.282	Medium	11
17-7 PH	200	185	600	6.7	0.276	Medium	14
AM 350	200	162	800	7.2	0.282	Medium	13
15-7 Mo	200	155	600	—	0.277	Medium	12
A-286	150	85	1200	9.72	0.286	Medium	6
A-286, cold worked	220	170	1200	—	0.286	High	7

Electroplating: Two broad classes of protective electroplating are: 1. The barrier type—such as chrome plating—which sets up an impervious layer or film that is more noble and therefore more corrosion resistant than the base metal. 2. The sacrificial type, zinc for example, where the metal of the coating is less noble than the base metal of the fastener. This kind of plating corrodes sacrificially and protects the fastener.

Noble-metal coatings are generally not suitable for threaded fasteners—especially where a close-tolerance fit is involved. To be effective, a noble-metal coating must be at least 0.001 in. thick. Because of screw-thread geometry, however, such plating thickness will usually exceed the tolerance allowances on many classes of fit for screws.

Because of dimensional necessity, threaded fastener coatings, since they operate on a different principle, are effective in layers as thin as 0.0001 to 0.0002 in.

The most widely used sacrificial platings for threaded fasteners are cadmium, zinc, and tin. Frequently, the cadmium and zinc are rendered even more corrosion resistant by a post-plating chromate-type conversion treatment. Cadmium plating can be used at temperatures to 450°F. Above this limit, a nickel cadmium or nickel-zinc alloy plating is recommended. This consists of alternate deposits of the two metals which are heat-diffused into a uniform alloy coating that can be used for applications to 900°F. The alloy may also be deposited directly from the plating bath.

Fastener materials for use in the 900 to 1200°F range (stainless steel, A-286), and in the 1200° to 1800°F range (high-nickel-base super alloys) are highly corrosion resistant and normally do not require protective coatings, except under special environment conditions.

Silver plating is frequently used in the higher temperature ranges for lubrication to prevent galling and seizing, particularly on stainless steel. This plating can cause a galvanic corrosion problem, however, because of the high nobility of the silver.

Hydrogen Embrittlement: A serious problem, known as hydrogen embrittlement, can develop in plated alloy steel fasteners. Hydrogen generated during plating can diffuse into the steel and embrittle the bolt. The result is often a delayed and total mechanical failure, at tensile levels far below the theoretical strength, high-hardness structural parts are particularly susceptible to this condition. The problem can be controlled by careful selection of plating formulation, proper plating procedure, and sufficient baking to drive off any residual hydrogen.

Another form of hydrogen embrittlement, which is more difficult to control, may occur after installation. Since electrolytic cell action liberates hydrogen at the cathode, it is possible for either galvanic or concentration-cell corrosion to lead to embrittling of the bolt material.

Joint Design

Certain precautions and design procedures can be followed to prevent, or at least minimize, each of the various types of corrosion likely to attack a threaded joint. The most important of these are:

For Direct Attack: Choose the right corrosion resistant material. Usually a material can be found that will provide the needed corrosion resistance without sacrifice of other important design requirements. Be sure that the fastener material is compatible with the materials being joined.

Corrosion resistance can be increased by using a conversion coating such as black oxide or a phosphate-base treatment. Alternatively, a sacrificial coating such as zinc plating is effective

For an inexpensive protective coating, lacquer or paint can be used where conditions permit.

For Galvanic Corrosion: If the condition is severe, electrically insulate the bolt and joint from each other..

The fastener may be painted with zinc chromate primer prior to installation, or the entire joint can be coated with lacquer or paint.

Another protective measure is to use a bolt that is cathodic to the joint material and close to it in the galvanic series. When the joint material is anodic, corrosion will spread over the greater area of the fastened materials. Conversely, if the bolt is anodic, galvanic action is most severe.

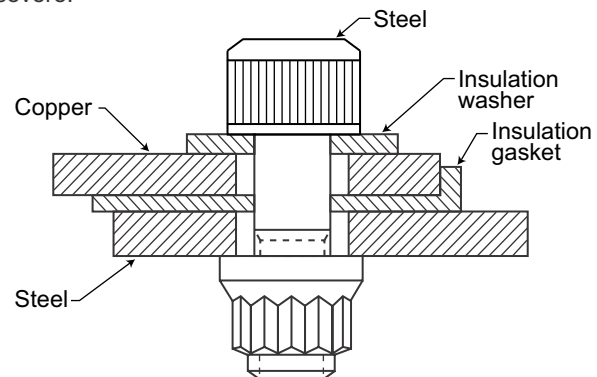

FIG. 1.1— A method of electrically insulating a bolted joint to prevent galvanic corrosion.

For Concentration-Cell Corrosion: Keep surfaces smooth and minimize or eliminate lap joints, crevices, and seams. Surfaces should be clean and free of organic material and dirt. Air trapped under a speck of dirt on the surface of the metal may form an oxygen concentration cell and start pitting.

For maximum protection, bolts and nuts should have smooth surfaces, especially in the seating areas. Flush-head bolts should be used where possible. Further, joints can be sealed with paint or other sealant material.

For Fretting Corrosion: Apply a lubricant (usually oil) to mating surfaces. Where fretting corrosion is likely to occur: 1. Specify materials of maximum practicable hardness. 2. Use fasteners that have residual compressive stresses on the surfaces that may be under attack. 3. Specify maximum preload in the joint. A higher clamping force results in a more rigid joint with less relative movement possible between mating services.

For Stress Corrosion: Choose a fastener material that resists stress corrosion in the service environment. Reduce fastener hardness (if reduced strength can be tolerated), since this seems to be a factor in stress corrosion.

Minimize crevices and stress risers in the bolted joint and compensate for thermal stresses. Residual stresses resulting from sudden changes in temperature accelerate stress corrosion.

If possible, induce residual compressive stresses into the surface of the fastener by shot-peening or pressure rolling.

For Corrosion Fatigue: In general, design the joint for high fatigue life, since the principal effect of this form of corrosion is reduced fatigue performance. Factors extending fatigue performance are: 1. Application and maintenance of a high preload. 2. Proper alignment to avoid bending stresses.

If the environment is severe, periodic inspection is recommended so that partial failures may be detected before the structure is endangered.

As with stress and fretting corrosion, compressive stresses induced on the fastener surfaces by thread rolling, fillet rolling, or shot peening will reduce corrosion fatigue. Further protection is provided by surface coating.

TYPES OF CORROSION

Direct Attack...most common form of corrosion affecting all metals and structural forms. It is a direct and general chemical reaction of the metal with a corrosive medium—liquid, gas, or even a solid.

Galvanic Corrosion...occurs with dissimilar metals contact. Presence of an electrolyte, which may be nothing more than an individual atmosphere, causes corrosive action in the galvanic couple. The anodic, or less noble material, is the sacrificial element. Hence, in a joint of stainless steel and titanium, the stainless steel corrodes. One of the worst galvanic joints would consist of magnesium and titanium in contact.

Concentration Cell Corrosion...takes place with metals in close proximity and, unlike galvanic corrosion, does not require dissimilar metals. When two or more areas on the surface of a metal are exposed to different concentrations of the same solution, a difference in electrical potential results, and corrosion takes place.

If the solution consists of salts of the metal itself, a metal-ion cell is formed, and corrosion takes place on the surfaces in close contact. The corrosive solution between the two surfaces is relatively more stagnant (and thus has a higher concentration of metal ions in solution) than the corrosive solution immediately outside the crevice.

A variation of the concentration cell is the oxygen cell in which a corrosive medium, such as moist air, contains different amounts of dissolved oxygen at different points. Accelerated corrosion takes place between hidden surfaces (either under the bolt head or nut, or between bolted materials) and is likely to advance without detection.

Fretting...corrosive attack or deterioration occurring between containing, highly-loaded metal surfaces subjected to very slight (vibratory) motion. Although the mechanism is not completely understood, it is probably a highly accelerated form of oxidation under heat and stress. In threaded joints, fretting can occur between mating threads, at the bearing surfaces under the head of the screw, or under the nut. It is most likely to occur in high tensile, high-frequency, dynamic-load applications. There need be no special environment to induce this form of corrosion...merely the presence of air plus vibratory rubbing. It can even occur when only one of the materials in contact is metal.

Stress Corrosion Cracking...occurs over a period of time in high-stressed, high-strength joints. Although not fully understood, stress corrosion cracking is believed to be caused by the combined and mutually accelerating effects of static tensile stress and corrosive environment. Initial pitting somehow takes place which, in turn, further increases stress build-up. The effect is cumulative and, in a highly stressed joint, can result in sudden failure.

Corrosion Fatigue...accelerated fatigue failure occurring in the presence of a corrosive medium. It differs from stress corrosion cracking in that dynamic alternating stress, rather than static tensile stress, is the contributing agent.

Corrosion fatigue affects the normal endurance limit of the bolt. The conventional fatigue curve of a normal bolt joint levels off at its endurance limit, or maximum dynamic load that can be sustained indefinitely without fatigue failure. Under conditions of corrosion fatigue, however, the curve does not level off but continues downward to a point of failure at a finite number of stress cycles.

GALVANIC CORROSION

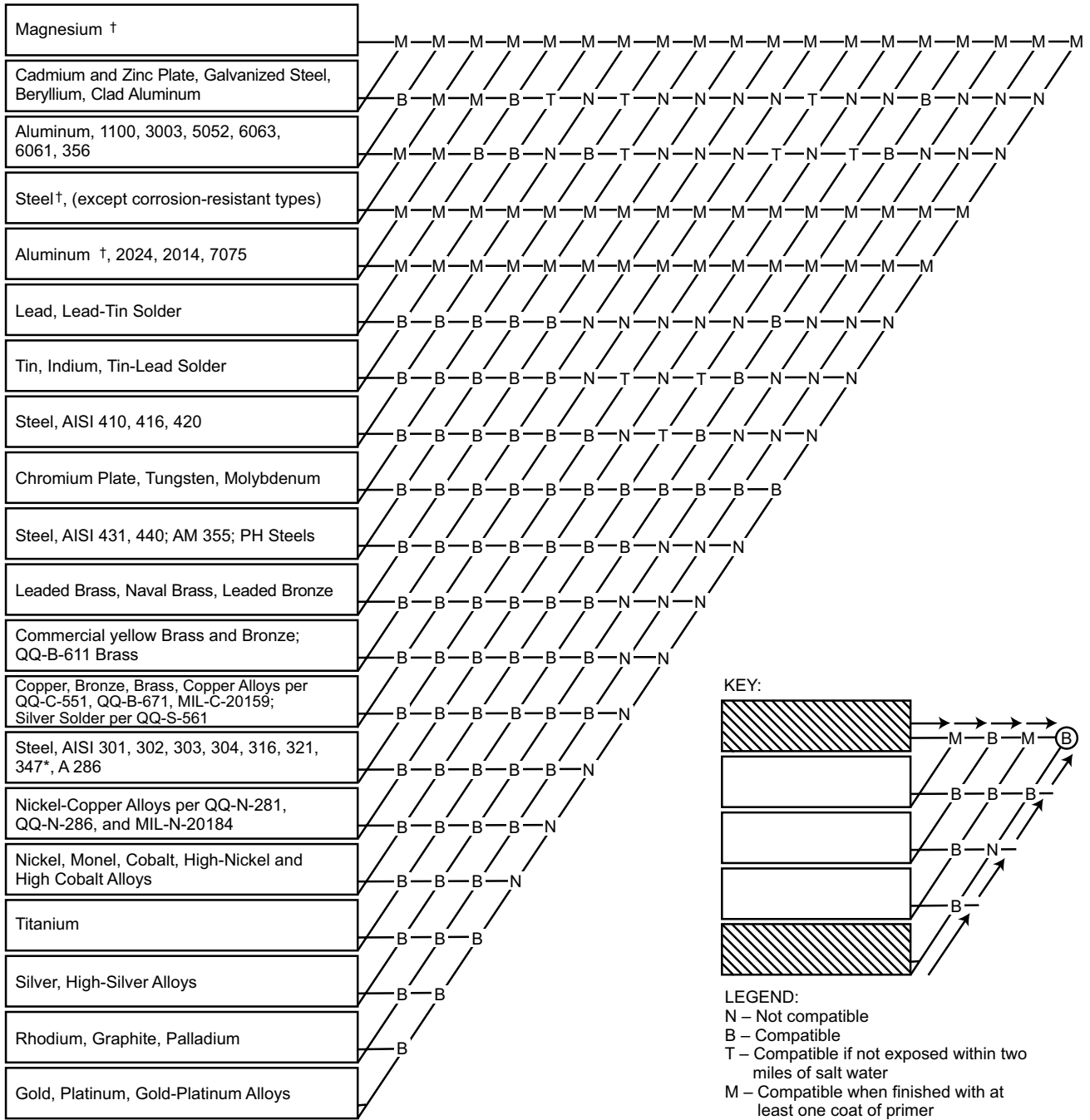

FIG. 19— Metals compatibility chart

THE IMPACT PERFORMANCE OF THREADED FASTENERS

Much has been written regarding the significance of the notched bar impact testing of steels and other metallic materials. The Charpy and Izod type test relate notch behavior (brittleness versus ductility) by applying a single overload of stress. The results of these tests provide quantitative comparisons but are not convertible to energy values useful for engineering design calculations. The results of an individual test are related to that particular specimen size, notch geometry and testing conditions and cannot be generalized to other sizes of specimens and conditions.

The results of these tests are useful in determining the susceptibility of a material to brittle behavior when the applied stress is perpendicular to the major stress.

In externally threaded fasteners, however, the loading usually is applied in a longitudinal direction. The impact test, therefore, which should be applicable would be one where the applied impact stress supplements the major stress. Only in shear loading on fasteners is the major stress in the transverse direction.

Considerable testing has been conducted in an effort to determine if a relationship exists between the Charpy V notch properties of a material and the tension properties of an externally threaded fastener manufactured from the same material.

Some conclusions which can be drawn from the extensive impact testing are as follows:

1. The tension impact properties of externally threaded fasteners do not follow the Charpy V notch impact pattern.
2. Some of the variables which effect the tension impact properties are:
 - A. The number of exposed threads
 - B. The length of the fastener
 - C. The relationship of the fastener shank diameter to the thread area.
 - D. The hardness or fastener ultimate tensile strength

Following are charts showing tension impact versus Charpy impact properties, the effect of strength and diameter on tension impact properties and the effect of test temperature.

Please note from figure 21 that while the Charpy impact strength of socket head cap screw materials are decreasing at sub-zero temperatures, the tension impact strength of the same screws is increasing. This compares favorably with the effect of cryogenic temperatures on the tensile strength of the screws. Note the similar increase in tensile strength shown in figure 22.

It is recommended, therefore, that less importance be attached to Charpy impact properties of materials which are intended to be given to impact properties for threaded fasteners. If any consideration is to be given to impact properties of bolts or screws, it is advisable to investigate the tension impact properties of full size fasteners since this more closely approximates the actual application.

TABLE 20
LOW-TEMPERATURE IMPACT PROPERTIES OF SELECTED ALLOY STEELS

AISI no.	Composition, %					Heat Temperature*		Hardness Rc	Impact Energy, Ft.-lb					Transition Temp. (50% Brittle) °f
						Quenching Temp. F+	Tempering Temp. F		-300°F	-200°F	-100°F	0°F	100°F	
	C	Mn	Ni	Cr	Mo									
4340	0.38	0.77	1.65	0.93	0.21	1550	400	52	11	15	20	21	21	-
							600	48	10	14	15	15	16	-
							800	44	9	13	16	21	25	-
							1000	38	15	18	28	36	36	-130
							1200	30	15	28	55	55	55	-185
4360	0.57	0.87	1.62	1.08	0.22	1475	800	48	5	6	10	11	14	-
							1000	40	9	10	13	18	23	-10
							1200	30	12	15	25	42	43	-110
4380	0.76	0.91	1.67	1.11	0.21	1450	800	49	4	5	8	9	10	-
							1000	42	8	8	10	12	15	60
							1200	31	5	11	19	33	38	-50
4620	0.20	0.67	1.85	0.30	0.18	1650	300	42	14	20	28	35	35	-
							800	34	11	16	33	55	55	-
							1000	29	16	34	55	78	78	-
							1200	19	17	48	103	115	117	-
4640	0.43	0.69	1.78	0.29	0.20	1550	800	42	16	17	20	25	27	-
							1000	37	17	22	35	39	69	-190
							1200	29	17	30	55	97	67	-180
4680	0.74	0.77	1.81	0.30	0.21	1450	800	46	5	8	13	15	16	-
							1000	41	11	12	15	19	22	-
							1200	31	11	13	17	39	43	-
8620	0.20	0.89	0.60	0.68	0.20	1650	300	43	11	16	23	35	35	-
							800	36	8	13	20	35	45	-20
							1000	29	25	33	65	76	76	-150
							1200	21	10	85	107	115	117	-195
8630	0.34	0.77	0.66	0.62	0.22	1575	800	41	7	12	17	25	31	0
							1000	34	11	20	43	53	54	-155
							1200	27	18	28	74	80	82	-165
8640	0.45	0.78	0.65	0.61	0.20	1550	800	46	5	10	14	20	23	-
							1000	38	11	15	24	40	40	-110
							1200	30	18	22	49	63	66	-140
8660	0.56	0.81	0.70	0.56	0.25	1475	800	47	4	6	10	13	16	-
							1000	41	10	12	15	20	30	-10
							1200	30	16	18	25	54	60	-90

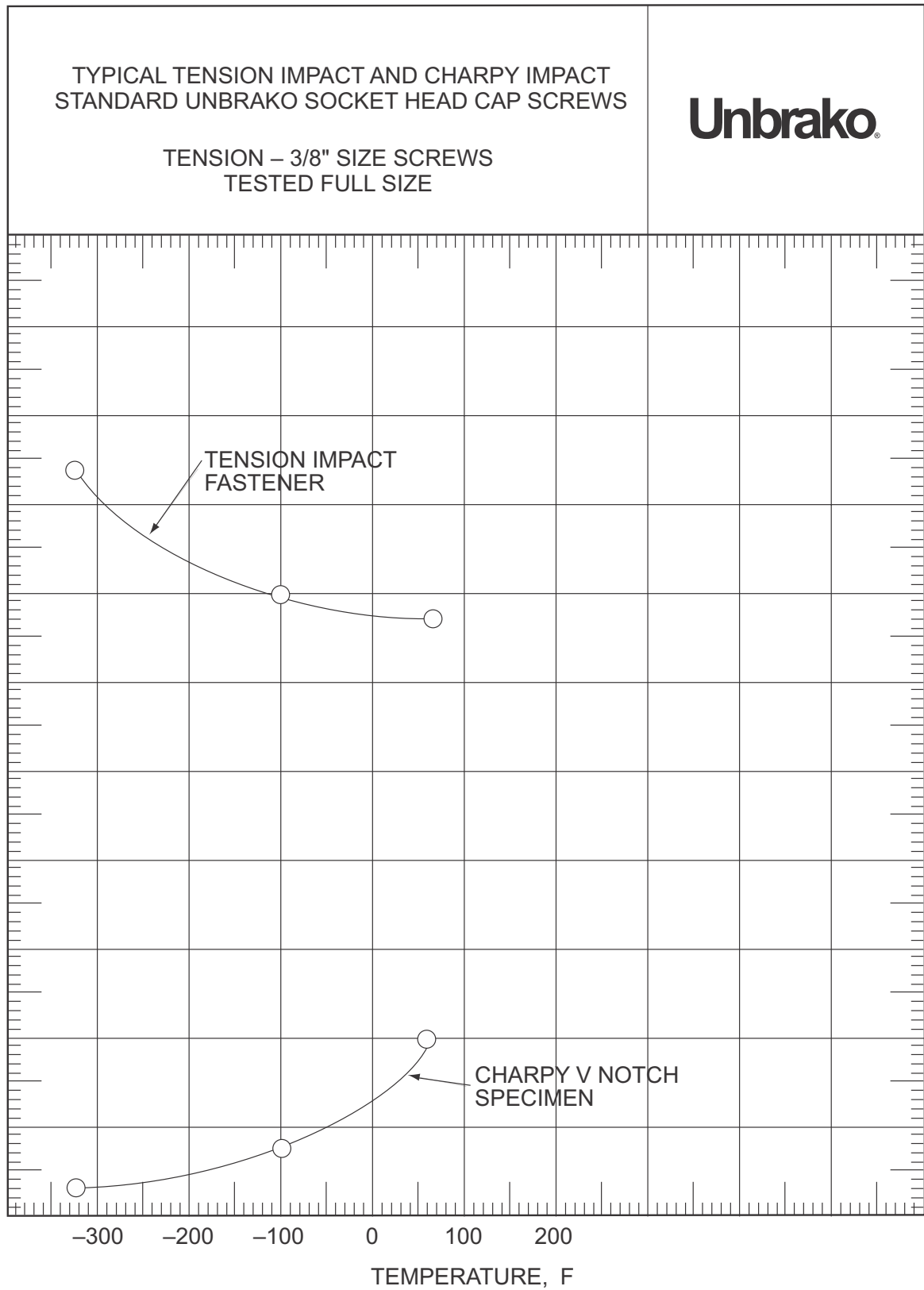

FIG. 21

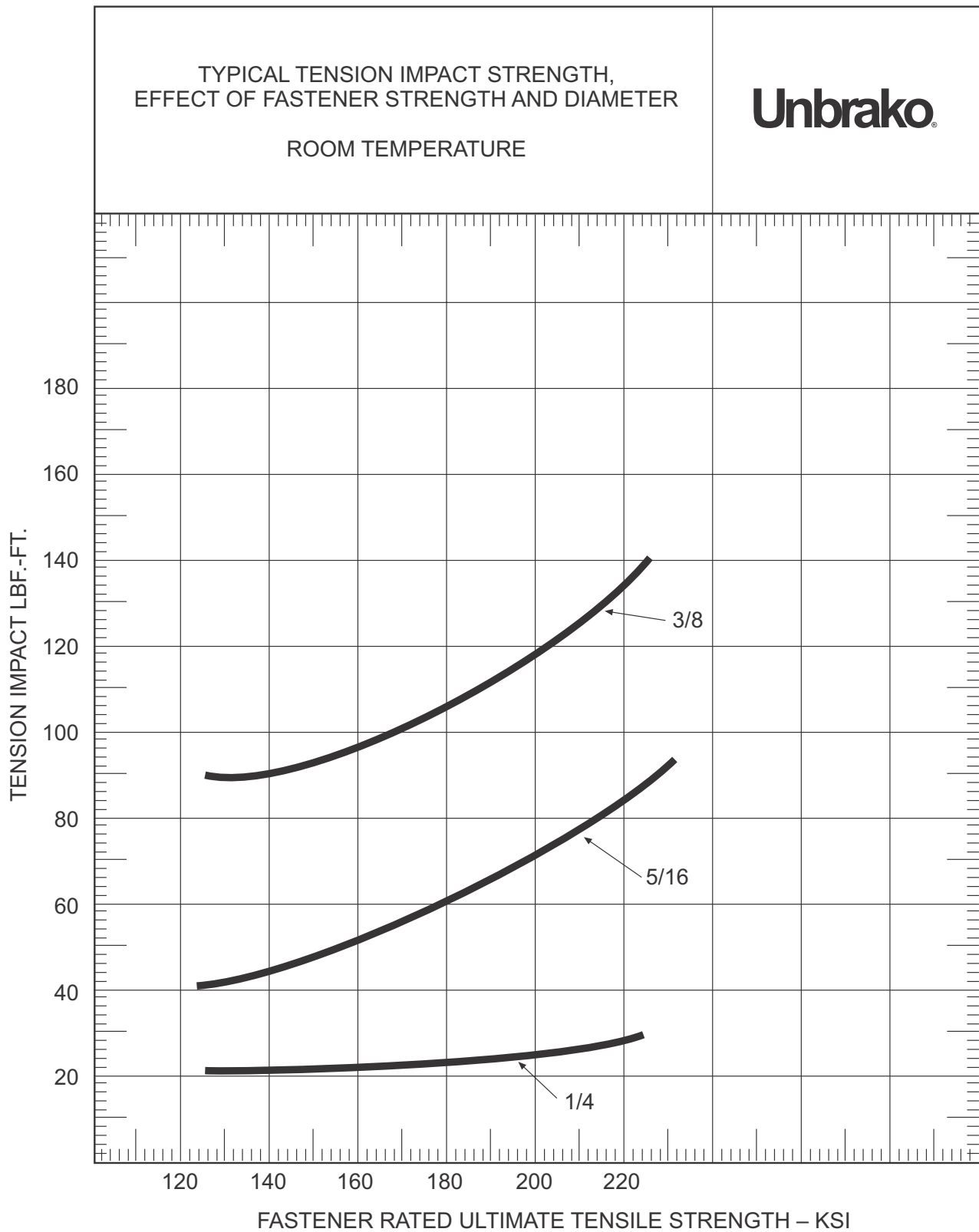

FIG. 22

Standard Inch Socket Head Cap Screws Are Not Grade 8 Fasteners

There is a common, yet reasonable, misconception that standard, inch, alloy steel socket head cap screws are “Grade 8”. This is not true. The misconception is reasonable because “Grade 8” is a term generally associated with “high strength” fasteners. A person desiring a “high strength” SHCS may request a “Grade 8 SHCS”. This is technically incorrect for standard SHCSs. The term Grade 8 defines specific fastener characteristics which must

be met to be called “Grade 8”. Three of the most important characteristics are not consistent with requirements for industry standard SHCSs: tensile strength, hardness, and head marking. Some basic differences between several fastener classifications are listed below. The list is not comprehensive but intended to provide a general understanding. SHCSs can be manufactured to meet Grade 8 requirements on a special order basis.

Fastener Designation	Grade2	Grade5	Grade8	Industry SHCS	Unbrako SHCS
Strength Level, UTS KSI, min.	74 (1/4-3/4) 60 (7/8-1 1/2)	120 (1/4 - 1) 105 (1 1/8 - 1 1/2)	150 (1/4 - 1 1/2)	180 (≤ 1/2) 170 (> 1/2)	190 (≤ 1/2) 180 (> 1/2)
Hardness, Rockwell	B80-B100 B70-B100	C25-C34 C19-C30	C33-C39	C39-C45 C37-C45	C39-C43 C38-C43
General Material Type	Low or Medium Carbon Steel	Medium Carbon Steel	Medium Carbon Alloy Steel	Medium Carbon Alloy Steel	Medium Carbon Alloy Steel
Identification Requirement	None	Three Radial Lines	Six Radial Lines	SHCS Configuration	Mfr's ID
Typical Fasteners	Bolts Screws Studs Hex Heads	Bolts Screws Studs Hex Heads	Bolts Screws Studs Hex Heads	Socket Head Cap Screw	Socket Head Cap Screw

THREADS IN BOTH SYSTEMS

Thread forms and designations have been the subject of many long and arduous battles through the years. Standardization in the inch series has come through many channels, but the present unified thread form could be considered to be the standard for many threaded products, particularly high strength ones such as socket head cap screws, etc. In common usage in U.S.A., Canada and United Kingdom are the Unified National Radius Coarse series, designated UNRC, Unified National Radius Fine series, designated UNRF, and several special series of various types, designated UNS.

This thread, UNRC or UNRF, is designated by specifying the diameter and threads per inch along with the suffix indicating the thread series, such as 1/4 - 28 UNRF. For threads in Metric units, a similar approach is used, but with some slight variations. A diameter and pitch are used to designate the series, as in the Inch system, with modifications as follows: For coarse threads, only the prefix M and the diameter are necessary, but for fine threads, the pitch is shown as a suffix. For example, M16 is a coarse thread designation representing a diameter of 16 mm with a pitch of 2 mm understood. A similar fine thread part would be M16 x 1.5 or 16 mm diameter with a pitch of 1.5 mm.

For someone who has been using the Inch system, there are a couple of differences that can be a little confusing. In the Inch series, while we refer to threads per inch as pitch; actually the number of threads is 1/pitch. Fine threads are referenced by a larger number than coarse threads because they “fit” more threads per inch.

In Metric series, the diameters are in millimeters, but the pitch is really the pitch. Consequently the coarse thread has the large number. The most common metric thread is the coarse thread and falls generally between the inch coarse and fine series for a comparable diameter.

Also to be considered in defining threads is the tolerance and class of fit to which they are made. The International Standards Organization (ISO) metric system provides for this designation by adding letters and numbers in a certain sequence to the callout. For instance, a thread designated as M5 x 0.8 4g6g would define a thread of 5 mm diameter, 0.8 mm pitch, with a pitch diameter tolerance grade 6 and allowance “g”. These tolerances and fields are defined as shown below, similar to the Federal Standard H28 handbook, which defines all of the dimensions and tolerances for a thread in the inch series. The callout above is similar to a designation class 3A fit, and has a like connotation.

COMPLETE DESIGNATIONS

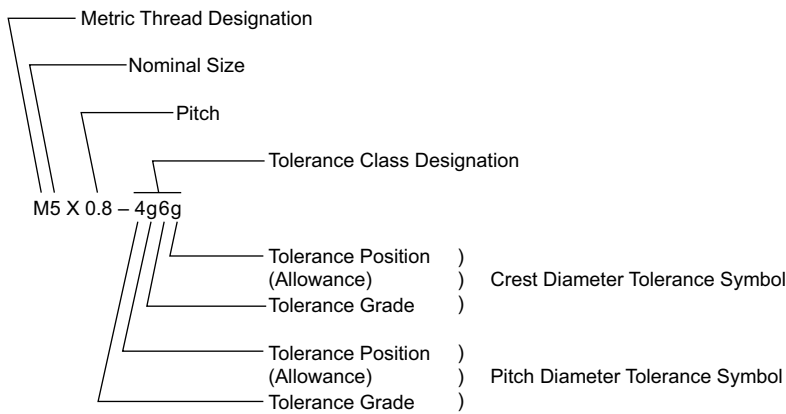

Example of thread tolerance positions and magnitudes. Comparison 5/16 UNC and M8. Medium tolerance grades — Pitch diameter.

DEVIATIONS

external	internal	basic clearance
h	H	none
g	G	small
e		large

NOTES:

Lower case letters = external threads
Capital letters = internal threads

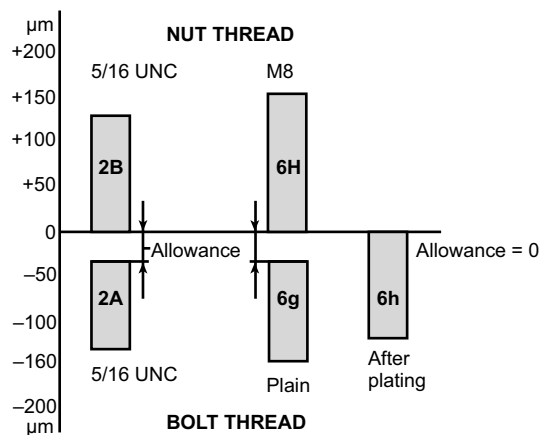

Close Fit: Normally limited to holes for those lengths of screws threaded to the head in assemblies in which: (1) only one screw is used; or (2) two or more screws are used and the mating holes are produced at assembly or by matched and coordinated tooling.

Normal Fit: Intended for: (1) screws of relatively long length; or (2) assemblies that involve two or more screws and where the mating holes are produced by conventional tolerancing methods. It provides for the maximum allowable eccentricity of the longest standard screws and for certain deviations in the parts being fastened, such as deviations in hole straightness; angularity between the axis of the tapped hole and that of the hole for the shank; differences in center distances of the mating holes and other deviations.

Chamfering: It is considered good practice to chamfer or break the edges of holes that are smaller than “F” maximum in parts in which hardness approaches, equals or exceeds the screw hardness. If holes are not chamfered, the heads may not seat properly or the sharp edges may deform the fillets on the screws, making them susceptible to fatigue in applications that involve dynamic loading. The chamfers, however, should not be larger than needed to ensure that the heads seat properly or that the fillet on the screw is not deformed. Normally, the chamfers do not need to exceed “F” maximum. Chamfers exceeding these values reduce the effective bearing area and introduce the possibility of indentation when the parts fastened are softer than screws, or the possibility of brinelling of the heads of the screws when the parts are harder than the screws.

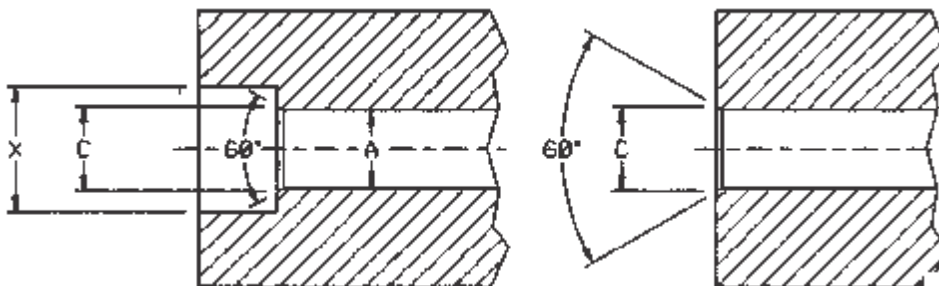

nominal size	basic screw diameter	A				X	C	hole dimensions					
		drill size for hole A						counter-bore diameter	countersink diameter D Max.+2F(Max.)	tap drill size		**body drill size	counter-bore size
		close fit		normal fit						UNRC	UNRF		
		nom.	dec.	nom.	dec.								
0	0.0600	51*	0.0670	49*	0.0730	1/8	0.074	–	3/64	#51	1/8		
1	0.0730	46*	0.0810	43*	0.0890	5/32	0.087	1.5mm	#53	#46	5/32		
2	0.0860	3/32	0.0937	36*	0.1065	3/16	0.102	#50	#50	3/32	3/16		
3	0.0990	36*	0.1065	31*	0.1200	7/32	0.115	#47	#45	#36	7/32		
4	0.1120	1/8	0.1250	29*	0.1360	7/32	0.130	#43	#42	1/8	7/32		
5	0.1250	9/64	0.1406	23*	0.1540	1/4	0.145	#38	#38	9/64	1/4		
6	0.1380	23*	0.1540	18*	0.1695	9/32	0.158	#36	#33	#23	9/32		
8	0.1640	15*	0.1800	10	0.1935	5/16	0.188	#29	#29	#15	5/16		
10	0.1900	5*	0.2055	2*	0.2210	3/8	0.218	#25	#21	#5	3/8		
1/4	0.2500	17/64	0.2656	9/32	0.2812	7/16	0.278	#7	#3	17/64	7/16		
5/16	0.3125	21/64	0.3281	11/32	0.3437	17/32	0.346	F	I	21/64	17/32		
3/8	0.0375	25/64	0.3906	13/32	0.4062	5/8	0.415	5/16	Q	25/64	5/8		
7/16	0.4375	29/64	0.4531	15/32	0.4687	23/32	0.483	U	25/64	29/64	23/32		
1/2	0.5000	33/64	0.5156	17/32	0.5312	13/16	0.552	27/64	29/64	33/64	13/16		
5/8	0.6250	41/64	0.6406	21/32	0.6562	1	0.689	35/64	14.5mm	41/64	1		
3/4	0.7500	49/64	0.7656	25/32	0.7812	1-3/16	0.828	21/32	11/16	49/64	1-3/16		
7/8	0.8750	57/64	0.8906	29/32	0.9062	1-3/8	0.963	49/64	20.5mm	57/64	1-3/8		
1	1.0000	1-1/64	1.0156	1-1/32	1.0312	1-5/8	1.100	7/8	59/64	1-1/64	1-5/8		
1-1/4	1.2500	1-9/32	1.2812	1-5/32	1.3125	2	1.370	1-7/64	1-11/64	1-9/32	2		
1-1/2	1.5000	1-17/32	1.5312	1-9/16	1.5625	2-3/8	1.640	34mm	36mm	1-17/32	2-3/8		

** Break edge of body drill hole to clear screw fillet.

DRILL AND COUNTERBORE SIZES FOR METRIC SOCKET HEAD CAP SCREWS

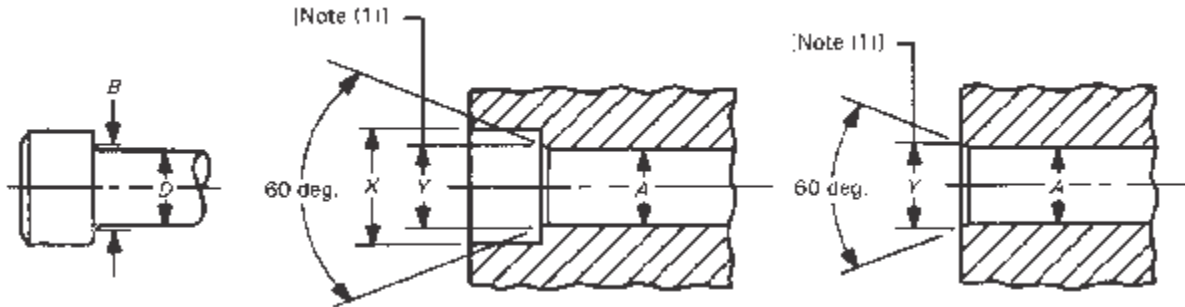

Nominal Size or Basic Screw Diameter	A		X	Y
	Nominal Drill Size			
	Close Fit [Note (2)]	Normal Fit [Note (3)]	Counterbore Diameter	Countersink Diameter [Note (1)]
M1.6	1.80	1.95	3.50	2.0
M2	2.20	2.40	4.40	2.6
M2.5	2.70	3.00	5.40	3.1
M3	3.40	3.70	6.50	3.6
M4	4.40	4.80	8.25	4.7
M5	5.40	5.80	9.75	5.7
M6	6.40	6.80	11.25	6.8
M8	8.40	8.80	14.25	9.2
M10	10.50	10.80	17.25	11.2
M12	12.50	12.80	19.25	14.2
M14	14.50	14.75	22.25	16.2
M16	16.50	16.75	25.50	18.2
M20	20.50	20.75	31.50	22.4
M24	24.50	24.75	37.50	26.4
M30	30.75	31.75	47.50	33.4
M36	37.00	37.50	56.50	39.4
M42	43.00	44.00	66.00	45.6
M48	49.00	50.00	75.00	52.6

ASTM Hardness Conversion Tables

ASTM Spec. E140 Based on Rockwell C (Non-austenitic steels)

Rockwell C 150 Kg Diamond	Rockwell A 60 Kg Diamond	Rockwell D 100 Kg Diamond Cone	Superficial Rockwell 15 Kg N Diamond	Superficial Rockwell 30 Kg N Diamond	Superficial Rockwell 45 Kg N Diamond	BHN Brinell Hardness * 3000 KG 10mm Ball	Vickers Hardness 500g	Tensile Strength ** KSI
C	A	D	15N	30N	45N	HB	HV	KSI
68	85.6	76.9	93.2	844	75.4		940	
67	85	76.1	92.9	83.6	74.2		900	
66	84.5	75.4	92.5	82.8	73.3		865	
65	83.9	74.5	92.2	81.9	72	739	832	
64	83.4	73.8	91.8	81.1	71	722	800	
63	82.8	73	91.4	80.1	69.9	705	772	
62	82.3	72.2	91.1	79.3	68.8	688	746	
61	81.8	71.5	90.7	78.4	67.7	670	720	
60	81.2	70.7	90.2	77.5	66.6	654	697	
59	80.7	69.9	89.8	76.6	65.5	634	674	
58	80.1	69.2	89.3	75.7	64.3	615	653	
57	79.6	68.5	88.9	74.8	63.2	595	633	
56	79	67.7	88.3	73.9	62	577	613	
55	78.5	66.9	87.9	73	60.9	560	595	301
54	78	66.1	87.4	72	59.8	543	577	291
53	77.4	65.4	86.9	71.2	58.6	525	560	283
52	76.8	64.6	86.4	70.2	57.4	512	544	273
51	76.3	63.8	85.9	69.4	56.1	496	528	264
50	75.9	63.1	85.5	68.5	55	481	513	256
49	75.2	62.1	85	67.6	53.8	469	498	246
48	74.7	61.4	84.5	66.7	52.5	455	484	237
47	74.1	60.8	83.9	65.8	51.4	443	471	231
46	73.6	60	83.5	64.8	50.3	432	458	221
45	73.1	59.2	83	64	49	421	446	215
44	72.5	68.5	82.5	63.1	47.8	409	434	208
43	72	57.7	82	62.2	46.7	400	423	201
42	71.5	56.9	81.5	61.3	45.5	390	412	194
41	70.9	56.2	80.9	60.4	44.3	381	402	188
40	70.4	55.4	80.4	59.5	43.1	371	392	181
39	69.9	54.6	79.9	58.6	41.9	362	382	176
38	69.4	53.8	79.4	57.7	40.8	353	372	170
37	68.9	53.1	78.8	56.8	39.6	344	363	165
36	68.4	52.3	78.3	55.9	38.4	336	354	160
35	67.9	51.5	77.7	55	37.2	327	345	155
34	67.4	50.8	77.2	54.2	36.1	319	336	150
33	66.8	50	76.6	53.3	34.9	311	327	147
32	66.3	49.2	76.1	52.1	33.7	301	318	142
31	65.8	48.4	75.6	51.3	32.5	294	310	139
30	65.3	47.7	75	50.4	31.3	286	302	136
29	64.6	47	74.5	49.5	30.1	279	294	132
28	64.3	46.1	73.9	48.6	28.9	271	286	129
27	63.8	45.2	73.3	47.7	27.8	264	279	126
26	63.3	44.6	72.8	46.8	26.7	258	272	123
25	62.8	43.8	72.2	45.9	25.5	253	266	120
24	62.4	43.1	71.6	45	24.3	247	260	118
23	62	42.1	71	44	23.1	243	254	115
22	61.5	41.6	70.5	43.2	22	237	248	112
21	61	40.9	69.9	42.3	20.7	231	243	110
20	60.5	40.1	69.4	41.5	19.6	226	238	104

* Numbers above BHN 615 are outside recommended range for Brinell testing ASTM method F10

** Tensile Strength in relation to hardness is inexact unless determined for specific material

Rockwell B 100 Kg 1/16" Ball	Rockwell A 60 Kg Diamond	Rockwell F 60 Kg 1/16" Ball	Superficial Rockwell 15 Kg Ball	Superficial Rockwell 30 Kg Ball	Superficial Rockwell 45 Kg Ball	BHN Brinell Hardness 3000 KG 10mm Ball	DPH Vickers 500g	Knoop Hardness 500g	Tensile Strength KSI
B	A	F	15T	30T	45T	HB	HV	HK	KSI
100	61.5		93.1	83.1	72.9	240	240	251	116
99	60.9		92.8	82.5	71.9	234	234	246	114
98	60.2		92.5	81.8	70.9	228	228	241	109
97	59.5		92.1	81.1	69.9	222	222	236	104
96	58.9		91.8	80.4	68.9	216	216	231	102
95	58.3		91.5	79.8	67.9	210	210	226	100
94	57.6		91.2	79.1	66.9	205	205	221	98
93	57		90.8	78.4	65.9	200	200	216	94
92	56.4		90.5	77.8	64.8	195	195	211	92
91	55.8		90.2	77.1	63.8	190	190	206	90
90	55.2		89.9	76.4	62.8	185	185	201	89
89	54.6		89.5	75.8	61.8	180	180	196	88
88	54		89.2	75.1	60.8	176	176	192	86
87	53.4		88.9	74.4	59.8	172	172	188	84
86	52.8		88.6	73.8	58.8	169	169	184	83
85	52.3		88.2	73.1	57.8	165	165	180	82
84	51.7		87.9	72.4	56.8	162	162	176	81
83	51.1		87.6	71.8	55.8	159	159	173	80
82	50.6		87.3	71.1	54.8	156	156	170	77
81	50		86.9	70.4	53.8	153	153	167	73
80	49.5		86.6	69.7	52.8	150	150	164	72
79	48.9		86.3	69.1	51.8	147	147	161	70
78	48.4		86	68.4	50.8	144	144	158	69
77	47.9		85.6	67.7	49.8	141	141	155	68
76	47.3		85.3	67.1	48.8	139	139	152	67
75	46.8	99.6	85	66.4	47.8	137	137	150	66
74	46.3	99.1	84.7	65.7	46.8	135	135	147	65
73	45.8	98.5	84.3	65.1	45.8	132	132	145	65
72	45.3	98	84	64.4	44.8	130	130	143	65
71	44.8	97.4	83.7	63.7	43.8	127	127	141	65
70	44.3	96.8	83.4	63.1	42.8	125	125	139	65
69	43.8	96.2	83	62.4	41.8	123	123	137	65
68	43.3	95.6	82.7	61.7	40.8	121	121	135	65
67	42.8	95.1	82.4	61	39.8	119	119	133	65
66	42.3	94.5	82.1	60.4	38.7	117	117	131	65
65	41.8	93.9	81.8	59.7	37.7	116	116	129	65
64	41.4	93.4	81.4	59	36.7	114	114	127	65
63	40.9	92.8	81.1	58.4	35.7	112	112	125	65
62	40.4	92.2	80.8	57.7	34.7	110	110	124	65
61	40	91.7	80.5	57	33.7	108	108	122	65
60	39.5	91.1	80.1	56.4	32.7	107	107	120	65
59	39	90.5	79.8	55.7	31.7	106	106	118	65
58	38.6	90	79.5	55	30.7	104	104	117	65
57	38.1	89.4	79.2	54.4	29.7	103	103	115	65
56	37.7	88.8	78.8	53.7	28.7	101	101	114	65
55	37.2	88.2	78.5	53	27.7	100	100	112	65
54	36.8	87.7	78.2	52.4	26.7			111	65
53	36.3	87.1	77.9	51.7	25.7			110	65
52	35.9	86.5	77.5	51	24.7			109	65
51	35.5	86	77.2	50.3	23.7			108	65
50	35	85.4	76.9	49.7	22.7			107	65
49	34.6	84.8	76.6	49	21.7			106	65
48	34.1	84.3	76.2	48.3	20.7			105	65
47	33.7	83.7	75.9	47.7	19.7			104	65
46	33.3	83.1	75.6	47	18.7			103	65
45	32.9	82.6	75.3	46.3	17.7			102	65
44	32.4	82	74.9	45.7	16.7			101	65
43	32	81.4	74.6	45	15.7			100	65
42	31.6	80.8	74.3	44.3	14.7			99	65
41	31.2	80.3	74	43.7	13.6			98	65
40	30.7	79.7	73.6	43	12.6			97	65
39	30.3	79.1	73.3	42.3	11.6			96	65
38	29.9	78.6	73	41.6	10.6			95	65
37	29.5	78	72.7	41	9.6			94	65
36	29.1	77.4	72.3	40.3	8.6			93	65
35	28.7	76.9	72	39.6	7.6			92	65
34	28.2	76.3	71.7	39	6.6			91	65
33	27.8	75.7	71.4	38.3	5.6			90	65
32	27.4	75.2	71	37.6	4.6			89	65
31	27	74.6	70.7	37	3.6			88	65
30	26.6	74	70.4	36.3	2.6			87	65

STRESS AREAS FOR THREADED FASTENERS — INCH

Diameter (in.)		Diameter (mm)	Threads Per in.		Square Inches		
					Tensile Stress Area Per H-28		Nominal Shank
			UNRC	UNRF	UNRC	UNRF	
#0	0.06	1.52	—	80	—	0.00180	0.002827
#1	0.07	1.85	64	72	0.00263	0.00278	0.004185
#2	0.09	2.18	56	64	0.00370	0.00394	0.005809
#3	0.10	2.51	48	56	0.00487	0.00523	0.007698
#4	0.11	2.84	40	48	0.00604	0.00661	0.009852
#5	0.13	3.18	40	44	0.00796	0.00830	0.012272
#6	0.14	3.51	32	40	0.00909	0.01015	0.014957
#8	0.16	4.17	32	36	0.0140	0.01474	0.021124
#10	0.19	4.83	24	32	0.0175	0.0200	0.028353
1/4	0.25	6.35	20	28	0.0318	0.0364	0.049087
5/16	0.31	7.94	18	24	0.0524	0.0580	0.076699
3/8	0.38	9.53	16	24	0.0775	0.0878	0.11045
7/16	0.44	11.11	14	20	0.1063	0.1187	0.15033
1/2	0.50	12.70	13	20	0.1419	0.1599	0.19635
9/16	0.56	14.29	12	18	0.182	0.203	0.25
5/8	0.63	15.88	11	18	0.226	0.256	0.31
3/4	0.75	19.05	10	16	0.334	0.373	0.44179
7/8	0.88	22.23	9	14	0.462	0.509	0.60132
1	1.00	25.40	8	12	0.606	0.663	0.79
1-1/8	1.13	28.58	7	12	0.763	0.856	0.99402
1-1/4	1.25	31.75	7	12	0.969	1.073	1.2272
1-3/8	1.38	34.93	6	12	1.155	1.315	1.4849
1-1/2	1.50	38.10	6	12	1.405	1.581	1.7671
1-3/4	1.75	44.45	5	12	1.90	2.19	2.4053
2	2.00	50.80	4-1/2	12	2.50	2.89	3.1416
2-1/4	2.25	57.15	4-1/2	12	3.25	3.69	3.9761
2-1/2	2.50	63.50	4	12	4.00	4.60	4.9088
2-3/4	2.75	69.85	4	12	4.93	5.59	5.9396
3	3.00	76.20	4	12	5.97	6.69	7.0686

STRESS AREAS FOR THREADED FASTENERS — METRIC

Nominal Dia. Thread and Pitch (mm)	Thread Tensile Stress Area (mm ²)	Nominal Shank Area (mm ²)
1.6 x 0.35	1.27	2.01
2.0 x 0.4	2.07	3.14
2.5 x 0.45	3.39	4.91
3.0 x 0.5	5.03	7.07
4.0 x 0.7	8.78	12.6
5.0 x 0.8	14.2	19.6
6.0 x 1	20.1	28.3
8.0 x 1.25	36.6	50.3
10 x 1.5	58.00	78.5
12 x 1.75	84.3	113
14 x 2	115	154
16 x 2	157	201

Nominal Dia. Thread and Pitch (mm)	Thread Tensile Stress Area (mm ²)	Nominal Shank Area (mm ²)
18 x 2.5	192	254
20 x 2.5	245	314
22 x 2.5	303	380
24 x 3	353	452
27 x 3	459	573
30 x 3.5	561	707
33 x 3.5	694	855
36 x 4	817	1018
42 x 4.5	1120	1385
48 x 5	1470	1810

Thread Size Comparison



METRIC PRODUCTS						
SIZE	THREAD PITCH & T.P.I.				Major Dia	
	COARSE		FINE			
	PITCH mm	T.P.I.	PITCH mm	T.P.I.	mm	inch
M3	0.50	51	-	-	3.00	0.118
M4	0.70	36	-	-	4.00	0.157
M5	0.80	32	-	-	5.00	0.197
M6	1.00	25	-	-	6.00	0.236
M8	1.25	20	1.00	25	8.00	0.315
M10	1.50	17	1.25	20	10.00	0.394
M12	1.75	14.50	1.25	20	12.00	0.472
(M14)	2.00	12.50	1.50	17	14.00	0.551
M16	2.00	12.50	1.50	17	16.00	0.630
(M18)	2.50	10	1.50	17	18.00	0.709
M20	2.50	10	1.50	17	20.00	0.787
(M22)	2.50	10	1.50	17	22.00	0.866
M24	3.00	8.50	2.00	12.50	24.00	0.945
(M27)	3.00	8.50	2.00	12.50	27.00	1.063
M30	3.50	7.25	2.00	12.50	30.00	1.181
(M33)	3.50	7.25	2.00	12.50	33.00	1.299
M36	4.00	6.40	3.00	8.5	36.00	1.417
(M39)	4.00	6.40	3.00	8.5	39.00	1.535
M42	4.50	5.60	3.00	8.5	42.00	1.653

UNIFIED INCH PRODUCTS				B.S. INCH PRODUCTS			
SIZE	T.P.I.		Major Dia inch	SIZE	T.P.I.		Major Dia inch
	UNC	UNF			BSW	BSF	
#5	40	44	0.125	1/8	40	-	0.125
#6	32	40	0.138				
#8	32	36	0.164				
#10	24	32	0.190	3/16	24	32	0.187
1/4	20	28	0.250	1/4	20	26	0.250
5/16	18	24	0.313	5/16	18	22	0.313
3/8	16	24	0.375	3/8	16	20	0.375
				7/16	14	18	0.438
1/2	13	20	0.500	1/2	12	16	0.500
5/8	11	18	0.625	5/8	11	14	0.625
3/4	10	16	0.750	3/4	10	12	0.750
7/8	9	14	0.875	7/8	9	11	0.875
1	8	12	1.000	1	8	10	1.000
1 1/8	7	12	1.125	1 1/8	7	9	1.125
1 1/4	7	12	1.250	1 1/4	7	9	1.250
1 1/2	6	12	1.500	1 1/2	6	8	1.500

Comparison of Different Strength Grades



SAE	I.S. I.S.O. DIN	ULTIMATE TENSILE STRENGTH		YIELD STRENGTH MIN.		HARDNESS		
		Newton/mm ² Min (kgf/mm ²)	Pounds/in ² Min (kgf/mm ²)	Newton/mm ² (kgf/mm ²)	Pounds/in ² (kgf/mm ²)	BHN	HRb	HRc
-	4.6	400 (40.8)	-	240 (24.5)	-	114 / 238	67 / 99.5	
Grade 1			60.000 (42.3)		36,000 (25.4)	(121) / (241)	70 / 100	
	4.8	420 (42.8)		340 (34.7)		124 / 238	71 / 99.5	
	5.6	500 (51.0)		300 (30.6)		147 / 238	79 / 99.5	
Grade 2			74.000 (52.1)		57,000 (40.2)	(154) / (241)	80 / 100	
	5.8	520 (53.0)		420 (42.8)		152 / 238	82 / 99.5	
	6.8	600 (61.2)		480 (48.9)		181 / 238	89 / 99.5	
	8.8	800 ≤ M16 (81.6) 830 ≥ M16 (84.6)		640 (65.2) 660 (67.3)		238 / 304 242 / 319		22 / 32 23 / 34
Grade 5			1,20.000 (84.6)		92,000 (64.8)	(266) / (318)		25 / 34
Grade 8			1,50.000 (105.7)		1,30,000 (91.6)	(311) / (362)		33 / 39
	10.9	1,040 (106.0)		940 (95.8)		304 / 362		32 / 39
	12.9	1,220 (124.4)		1100 (112.0)		366 / 412		39 / 44

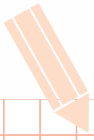

NOTES

A large grid of orange lines covering the majority of the page, intended for taking notes.

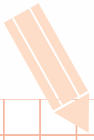

NOTES

A large grid of orange lines covering the majority of the page, intended for taking notes.



Unbrako
THE WORLD LEADER

Authorized Distributor:

