

STOPS

See :
Supports and
Bump stops



Cylindrical
stop



Conical
progressive
stop



LEVAFLEX
progressive
stop



EVIDGOM
stop

DESCRIPTION

There are several types of stops :

- cylindrical or DIABOLO stops;
- conical progressive stops;
- LEVAFLEX progressive stops with central cavity;
- EVIDGOM stops.

OPERATION

The design of the PAULSTRA elastic stops gives the following basic characteristics :

- highly deformable allowing high energies to be absorbed;
- progressive absorption of energy due to the carefully designed shape.

Advantages

- By comparison with rigid stops, PAULSTRA elastic stops are quiet and avoid hammering and deterioration of equipment.

Recommendations

- The stops must be fitted so that, on impact, the axis of the stop is perpendicular to the contact surface.
- On impact, the external diameter of the stop increases: this must be allowed for when fixing.

DIMENSIONS AND OPERATING CHARACTERISTICS

CYLINDRICAL STOPS

Shape 1

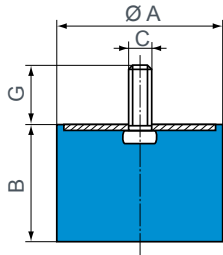

Shape 2

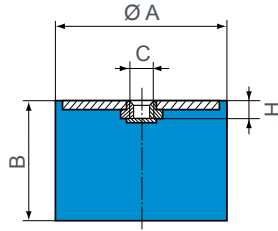

Ø A (mm)	B (mm)	C	G (mm)	Shape	H (mm)	Max. load (daN)	Deflect. (mm)	Energy (joules)	Reference		
12,5	10	M5	10	1	-	12	2	0,12	511110		
	13,5					2,5	0,13	511128			
	15					3	0,16	511115			
	20					3,5	0,14	511125			
16	10	M4	10	1	-	20	2	0,20	511150		
	15		1	2,5	3	0,30	511151				
	10		2	2	2	0,20	511152				
	15		2	2,5	3	0,30	511153				
	15		-	2	2	20	2	0,20	511292		
20	15	M6	16,5	1	-	20	3	0,30	511294		
	20					4	0,30	511296			
	25					5	0,30	511298			
	15					5	0,30	511298			
25,5	10	M6	18	1	-	80	2	0,80	511158		
	15					3,5	1,00	511155			
	20					5	1,20	511159			
	30					8	2,00	511160			
	15					2	4	60	3,5	1,00	511164
30	20	M6	18	1	-	50	8	2,00	511160		
	15					2	4	55	5,5	1,20	511162
	20					2	4	55	5,5	1,20	511162
	30					2	4	50	8	2,00	511163

Ø A (mm)	B (mm)	C	G (mm)	Shape	H (mm)	Max. load (daN)	Deflect. (mm)	Energy (joules)	Reference
25,5	10	M8	20	1	-	80	2	0,80	511265
	15					3,5	1,00	511270	
	19					4,5	1,20	511251	
	22					5,5	1,30	511275	
	25					6	1,50	511280	
	30					8	2,00	511285	
	40					10	2,50	511290	
30	22	M8	-	2	6	80	6	2,40	511156
	15					90	3,5	1,50	511308
	22					80	6	2,40	511310
	30					70	8	2,80	511312
40	30	M8	20	1	-	120	7	4,60	511157
	40					120	10	6,00	511161
	25					160	5	4,00	511450
	20					150	6	4,50	511401
	35					120	8	4,80	511452
50	25	M10	25	1	-	300	6	9,00	511525
	35					250	9	11,20	511535
	25					190	11	10,00	511545
	45					120	10	6,00	511454
60	25	M10	25	1	-	400	6	12,00	511625
	36					300	9	13,50	511635
	45					250	11	13,70	511645
	35					450	9	20,00	511735
70	50	M10	25	1	-	350	12	21,00	511750
	70					300	14	21,00	511770
	35					450	9	20,00	511735
75	24	M12	37	1	-	600	4,5	13,50	511751
80	25	M14	45	1	-	1100	6	33,00	513801
	30		35			8	38,00	511830	
	40		35			10	30,00	511840	
	70		35			17	42,50	511870	
	80		35			19	43,00	511880	

See current price list for availability of items.

CONICAL PROGRESSIVE STOPS

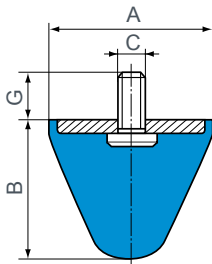

Reference	Ø A (mm)	B (mm)	C	G (mm)	Repetitive shocks			Exceptional shock energy (joules)	Weight (g)
					Energy (joules)	Deflect. (mm)	Reaction (daN)		
512251	25,5	19	M8	20	3	8	100	9	20
512307	30	30	M8	25	6	15	140	18	31
512301	30	30	M6	13,5	6	15	140	18	25
511962	40	39	M8	16	15	16	250	45	62
512515	50	50	M10	25	30	25	340	90	118
512501	50	50	M8	20	30	25	340	90	105
512516	50	64	M10	25	40	32	370	120	154
512502	50	64	M8	35	40	32	370	120	145
512517	50	58	M10	25	37	28	400	110	143
512503	50	58	M8	15	37	28	400	110	125
512608	60	40	M10	25	27	18	550	70	120
512601	60	40	M14	62	27	18	550	70	180
512700	72	58	M10	25	50	26	550	150	230
512721	72	58	M12	30	50	26	550	150	243
512951	95	80	M16	45	120	37	1 100	350	565

See current price list for availability of items.

DIABOLO STOPS

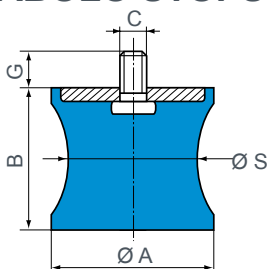

References	Ø S (mm)	Ø A (mm)	B (mm)	C	G (mm)	Max. instant. load (daN)	Deflect. (mm)	Max. static load (daN)	Deflect. (mm)	Energy (joules)	Weight (g)
511571	22	57	42	M8	20	100	10	10	4	1	60
511572	30	57	42	M8	20	200	12	75	5,5	2	80
511601	44	60	57	M10	25	350	15	150	8	6	190
511801	62	80	65	M14	30	800	16	300	9,5	15	500
511951	70	95	70	M16	47	1 000	18	400	9,5	20	790

LEVAFLEX PROGRESSIVE STOPS

Reference	A (mm)	B (mm)	Ø C (mm)	D (mm)	Ø E (mm)	Ø G (mm)	H (mm)	Weight (g)
514085	85	85	8,5	69	8,5	20	5	600
514110	110	110	12,5	90	8,5	30	6	1 200
514130	130	130	19	106	11	40	6	2 000
514160	160	160	23	132	11	45	8	3 000
514200	200	200	28	168	13	60	10	7 000

See current price list for availability of items.

Repetitive shocks			Exceptional shock energy (joules)	Reference hardness
Energy (joules)	Corresponding deflection (mm)	Reaction (daN)		
170	40	1 200	500	514085/60
280	40	1 700	850	514085/75
330	50	1 800	1 000	514110/60
550	50	3 400	1 500	514110/75
600	65	2 800	1 800	514130/60
650	60	3 000	1 900	514130/75
1 050	75	4 500	3 000	514160/60
1 200	90	4 000	3 600	514200/60
1 300	70	6 000	3 900	514160/75
2 200	85	7 800	6 600	514200/75

See current price list for availability of items.

EVIDGOM STOPS

Repetitive shocks			Exceptional shock energy (joules)	Reference hardness
Energy (joules)	Corresponding deflection (mm)	Reaction (daN)		
31	30	190	95	810644
100	50	580	300	810645
110	45	600	330	810666
180	67	750	540	810642
350	75	1 250	1 050	810653
360	65	1 400	1 100	810655
400	85	1 500	1 200	810669
300	70	900	-	810784
600	75	1 625	-	810775
1 050	90	2 375	-	810776
2 500	90	5 500	-	810733/60
7 100	150	11 000	-	810732/60
9 500	200	9 500	-	810731/60
13 000	130	18 000	-	810732/75
17 500	175	19 000	-	810731/75
21 000	200	25 000	-	810735/60
29 000	250	35 000	-	810734/60
41 000	200	70 000	-	810735/75
50 000	250	55 000	-	810734/75

See current price list for availability of items.

Stop reference	Shape	All rubber Evidgom reference	Ø A (mm)	B (mm)	C	Ø C1 (mm)	Ø C2 (mm)	Ø D (mm)	Ø A under load (mm)
810642	1	810022	85	120	M16	20	30	-	114
810644	1	810004	55	55	M10	14	14	-	72
810645	2	810035	66	93	M16	20	14	-	100
810653	1	810023	100	130	M16	20	30	-	140
810655	1	810025	110	132	M16	20	30	-	142
-	3	810026	60	100	-	14	20	-	75
-	3	810027	66	93	-	14	20	-	80
810666	2	810046	76	90	M16	20	14	-	98
810669	2	810029	110	150	M16	20	30	-	155
810731	3	-	250	400	2 x 6 x M24	70	70	150	360
810732	3	-	250	315	2 x 6 x M24	70	70	150	380
810733	3	-	250	230	2 x 6 x M24	70	70	150	370
810734	3	-	350	500	2 x 8 x M24	85	85	196	445
810735	3	-	350	395	2 x 8 x M24	85	85	196	500
810775	1	810015	155	150	M16	25	30	-	202
810776	1	810016	188	180	M24	40	40	-	256
810784	1	810014	125	140	M16	30	25	-	168

NOTA : The values are given for test conditions with an impact speed of 1 m/s. Consult us for speeds that are much higher.

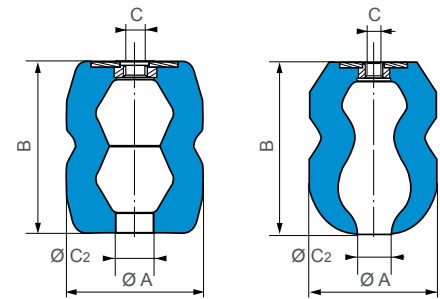
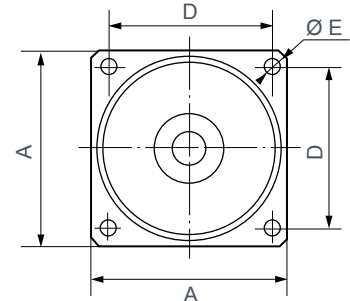
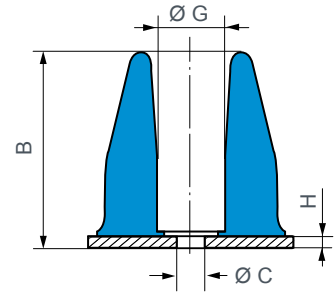

Shape 1

Shape 2

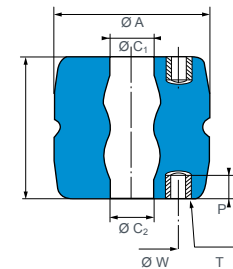

Shape 3

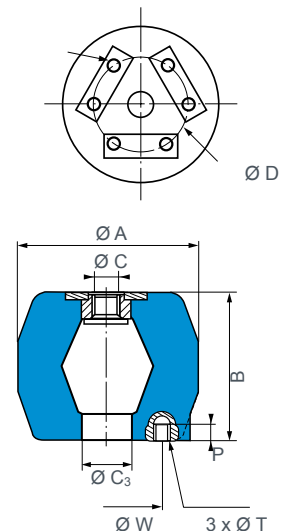

Shape 4

DEFLECTION CURVES AND ENERGY VALUES FOR PROGRESSIVE, LEVAFLEX AND EVIDGOM STOPS

