

### Features

- Can be used in many applications.
- Strong simple construction designed for repetitive high usage.
- Wide range available.



### Order example

**MFC-1012 T-M12x1.5** ※ Thread size M

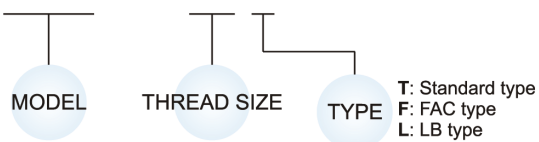

**T**

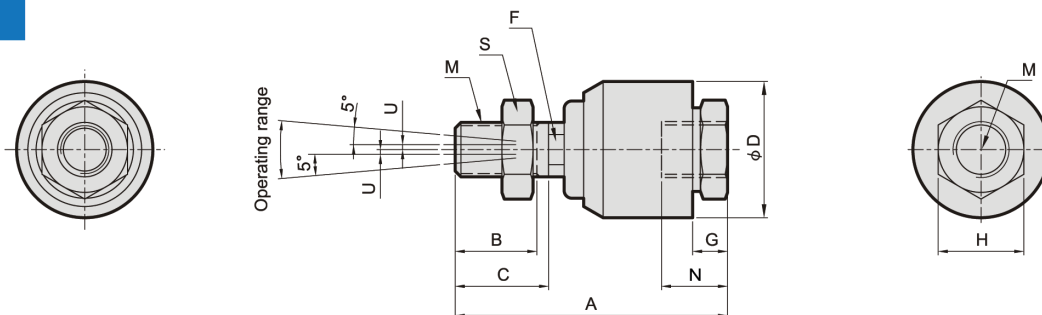

Model	Applicable cyl. dia. (mm)	A	B	C	φD	F	G	H	M	N	S	Permissible U deviation	Rot. angle	Permissible pressure	Maximum operating tension and compression force (N)	Weight (g)
MFC-1003T	6	24.5	7	8	12	○ 3	3.5	8	M3×0.5	7	M3×0.5×H2.5×B6	0.5	±5°	0.7MPa (max.) Pneumatic	1.9	10
MFC-1004T	10	26	8	9	12	□ 4	4	8	M4×0.7	7	M4×0.7×H3.5×B8				5.4	10
MFC-1005T	10, 15	38	14	15	18	□ 5	5	11	M5×0.8	8.5	M5×0.8×H4×B8				12.3	29
MFC-1006T	15	38	14	15	18	□ 6	5	11	M6×1.0	8.5	M6×1.0×H5×B10				12.3	30
MFC-1008T	20	50	18	20	24	□ 8	7	14	M8×1.25	12	M8×1.25×H6×B13	0.75	±5°	3.5MPa (max.) Pneumatic / Hydraulic	110	70
MFC-1010T	25, 30	61	20	22	26	□10	8	17	M10×1.25/1.5	14	M10×1.25/1.5×H6×B17				250	110
MFC-1012T	40	58	20	22	28	□12	8	17	M12×1.25/1.5/1.75	12	M12×1.25/1.5/1.75×H7×B19	1	±5°	3.5MPa (max.) Pneumatic / Hydraulic	440	120
MFC-1014T	40	70	21	24	35	□14	9	22	M14×1.5	17	M14×1.5×H8×B22				600	250
MFC-1016T	50, 63	90	26	28	45	□16	13	27	M16×1.5	23	M16×1.5×H8×B23	1.25	±5°	3.5MPa (max.) Pneumatic / Hydraulic	1100	502
MFC-1018T	50, 63	90	26	28	45	□18	13	27	M18×1.5	23	M18×1.5×H8×B24				1100	505
MFC-1020T	80	103	30	32	50	□20	16	32	M20×1.5	27	M20×1.5×H8.5×B30	2	±5°	3.5MPa (max.) Pneumatic / Hydraulic	1800	710
MFC-1022T	80	103	30	32	50	□22	16	32	M22×1.5	27	M22×1.5×H10×B32				1800	720
MFC-1024T	100	125	38	38	61	□24	20	41	M24×1.5	33	M24×1.5×H11×B35.5	2.5	±5°	3.5MPa (max.) Pneumatic / Hydraulic	2800	1280
MFC-1026T	100	125	38	38	61	□26	20	41	M26×1.5	33	M26×1.5×H11×B35				2800	1290
MFC-1027T	125	154	63	65	63.5	□27	19	41	M27×2.0	33	M27×2.0×H10×B50	3	±5°	3.5MPa (max.) Pneumatic / Hydraulic	2800	1670
MFC-1030T	125, 140	154	57	59	63.5	□30	19	41	M30×1.5/2.0/3.5	33	M30×1.5/2.0/3.5×H10×B46				5400	1680
MFC-1036T	160	184	68	70	75	□36	22	48	M36×1.5/2.0	42	M36×1.5/2.0×H10×B50	4	±5°	3.5MPa (max.) Pneumatic / Hydraulic	7100	2800
MFC-1040T	160	194	82	100	75	□40	20	54	M40×2.0	41	M40×2.0×H10×B50				7100	4160
MFC-1045T	160	194	78	95	85	□45	27	64	M45×1.5/2.0	40	M45×2.0×H12×B65	5	±5°	3.5MPa (max.) Pneumatic / Hydraulic	7100	4300
MFC-1050T	160	210	70	85	105	□50	36	85	M50×2.0	55	M50×2.0×H13×B65				7100	7250

### F

※ With S type floating joints.

Fig.1

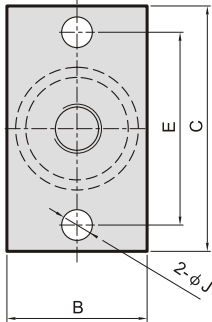
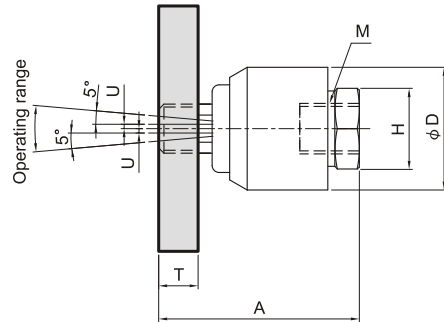
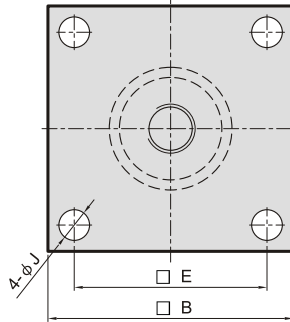

Fig.2



Model	A	B	C	φD	E	H	J	T	M	Illustration fig no.	Permissible U deviation	Rot. angle	Permissible pressure	Weight (g)
MFC-1008F	36	25	52	24	40	13	7	6	M8×1.25/1.0	Fig.1	0.5	±5°	3.5MPa (max.) Pneumatic / Hydraulic	130
MFC-1010F	46	32	56	26	44	17	7	9	M10×1.25		0.75			235
MFC-1012F	45	32	56	28	44	17	7	9	M12×1.25/1.5		1			240
MFC-1014F	58	38	80	35	60	22	11	12	M14×1.5		1			510
MFC-1016F	77	74	-	45	45	27	11	15	M16×1.5	Fig.2	1.25			1120
MFC-1018F	77	74	-	45	45	27	11	15	M18×1.5		1.25			1120
MFC-1020F	89	100	-	50	62	32	14	21	M20×1.5		2			2280
MFC-1022F	89	100	-	50	62	32	14	21	M22×1.5		2			2280
MFC-1024F	107	100	-	60	70	41	14	21	M24×1.5		2.5			2870
MFC-1026F	107	100	-	60	70	41	14	21	M26×1.5					2870
MFC-1027F	112	100	-	63.5	70	41	14	21	M27×2.0					3070
MFC-1030F	112	100	-	63.5	70	41	14	21	M30×1.5					3070
MFC-1036F	143	130	-	75	95	48	16	25	M36×1.5	4	5790			

### L

※ With T type floating joints.

Fig.1

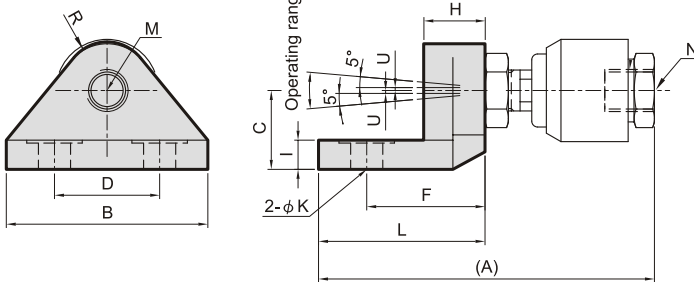
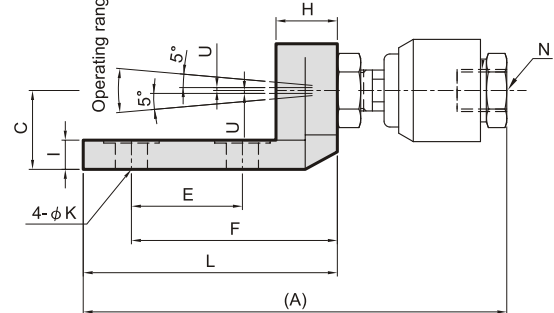

Fig.2



Model	A	B	C	D	E	F	H	I	K	L	R	M	N	Illustration fig no.	Permissible U deviation	Rot. angle	Permissible pressure	Weight (g)
MFC-1008L	71	44	15	26	-	19	11	8	9	32	10	M8×1.25	M8×1.25/1.0	Fig.1	0.5	±5°	3.5MPa (max.) Pneumatic / Hydraulic	150
MFC-1010L	85	44	19	26	-	24	12	5	9	36	11	M10×1.25	M10×1.25		0.75			200
MFC-1012L	82	44	19	26	-	24	12	5	9	36	11	M12×1.25	M12×1.25/1.5		1			205
MFC-1014L	115	69	22	36	-	40.5	21	10	11	57	16	M14×1.5	M14×1.5		1			600
MFC-1016L	163	61	28	32	32	76	32	15	11	90	17	M16×1.5	M16×1.5	Fig.2	1.25			1150
MFC-1018L	163	61	28	32	32	76	32	15	11	90	17	M18×1.5	M18×1.5		1.25			1150
MFC-1020L	190.5	68	35	36	36	89	40	21	14	108	21	M20×1.5	M20×1.5		2			1900
MFC-1022L	192	68	35	36	36	89	40	21	14	108	21	M22×1.5	M22×1.5		2			1900
MFC-1024L	214	69	42	36	36	95	45	26	14	113	21	M24×1.5	M24×1.5		2.5			2800
MFC-1026L	214	69	42	36	36	95	45	26	14	113	21	M26×1.5	M26×1.5					2800