



Panel Mounted Fault Annunciator Series



➔ BSM / USM - Panel-mounted fault annunciator

- › Annunciators for panel mounting with 8, 16, 24, 32, 40 and 48 signal inputs
- › Cascading of multiple devices to an annunciating system with up to 192 alarms possible
- › Integrated push buttons, function inputs, function relays, self-monitoring
- › Storing of process image in event of power failure, BSM-P and USM with integrated horn
- › All standardised reporting sequences implemented
- › Very bright RGB LED with large reading angle and slide-in pockets for individual labelling of LED and buttons
- › USM with communication interface according to Modbus RTU/TCP, IEC 60870-5-101/104 or IEC 61850 and parameterisation of all functions via integrated web server
- › optional:
 - Integrated 1:1 relays or DIN rail modules to forward individual alarms
 - Redundant power supply available in 2 voltage ranges
 - USM: Extended IT security according to BDEW guidelines
 - USM: Analog inputs with threshold monitoring and transmission of the values via interface

→ General system description - annunciator variants

The fault annunciator is available in three different categories:

- BSM-C: Basic version
- BSM-P: Software-parameterisable version
- USM: Annunciator with protocol interfaces

The fault annunciators are offered with 8, 16, 24, 32, 40 or 48 signal inputs. Each group is assigned to an slide-in pocket for individually created labeling strips. The signal inputs are combined in groups of 8 messages each. The closed front panel contains 4 buttons, 3 status LEDs and one RGB LED for each signal for which the 6 colour variants (red, green, yellow, blue, orange and white) can be parameterised.

On the BSM-C, the functions horn acknowledgement, message acknowledgement and lamp test are permanently assigned to the buttons. On the BSM-P and USM, these can be freely parameterized.

The two function inputs are used according to the chosen alarm sequence (e.g. external acknowledgement). The integrated function relays are realized as change-over contacts. They are used for alarm specific functions (e.g. collective report or triggering of an external horn) as well as for signaling of malfunction through an alive-contact.

The fault annunciator has a **status memory** for power failure. If the supply voltage fails, all visual and acoustic signals are switched off and the relays de-energized. During power failure, no new signals are registered and acknowledgements are not possible. After return of the supply, all conditions are immediately reactivated and the fault annunciator is ready for interactions and new alarms.

Many energy plants work unmanned at times and only in case of maintenance or faults someone comes to the side. For this purpose, two special functions have been integrated into the fault annunciator, which are indicated as an additional operating mode by flashing of the Alive-LED.

- **Mute function:** Affecting the horn triggering

- **Unmanned:** Affecting the horn triggering and the display, as well as the acknowledgement

More about these can be found on page 4.

Two methods can be used to not only display the individual fault alarms via LED, but also to forward them in parallel to the input or output via relay contact (1:1 relays):

1. Integration of additional relay cards (8 NO contacts each) for use as repeat output. For parameterisable annunciators BSM-P and USM the relays can be freely assigned. The relay cards are available as an option and have to be considered respectively when ordering.
2. Connection of external relay modules through CAN-Bus interface. Further details to these expansion modules can be found in the separate datasheet MSM-EM-DB-UK.



Further explanations to the implemented alarm sequences can be found in separate document "Description of alarm sequences" (document name SM-MA-ZI-UK).

→ BSM-C: Basic version

In the basic version, configuration of the annunciator is done by DIP-switches. The following settings can be done:

- Alarm sequence (first-up, no-first-up or operation indication)
- NO- or NC-principle of the inputs cardwise (8 inputs)
- Horn triggering by subsequent alarms
- Master/slave configuration and assignment of address for cascaded annunciator system

The function inputs, push buttons and function relays have the following fixed functions:

- Function input 1 - external horn acknowledgement
- Function input 2 - external acknowledgement
- Button 1 - horn acknowledgement
- Button 2 - acknowledgement
- Button 3 - lamp test
- Button 4 - no function assigned
- Relay 1 - collective report 1
- Relay 2 - no function assigned
- Relay 3 - external horn
- Relay 4 - watchdog-contact

Default Settings

- Collective report - static / parallel to output
- Horn - retriggerable by subsequent alarm and manual acknowledgement
- Horn lock - none

A system bus is available at the two CAN bus sockets to which relay extension modules can be connected or which are used to set up a cascaded alarm monitoring system - see section Cascading.

→ BSM-P: Software parameterisable version

Furthermore to the characteristics and interfaces of the basic version the BSM-P features an internal horn and a USB-interface (socket type B) which is used as service, diagnostic and parameterisation interface (SDP). This interface enables the parameterisation through PC program. In addition to the configurations via the DIP switch or the functional buttons, numerous further application-specific setting options are available herewith.

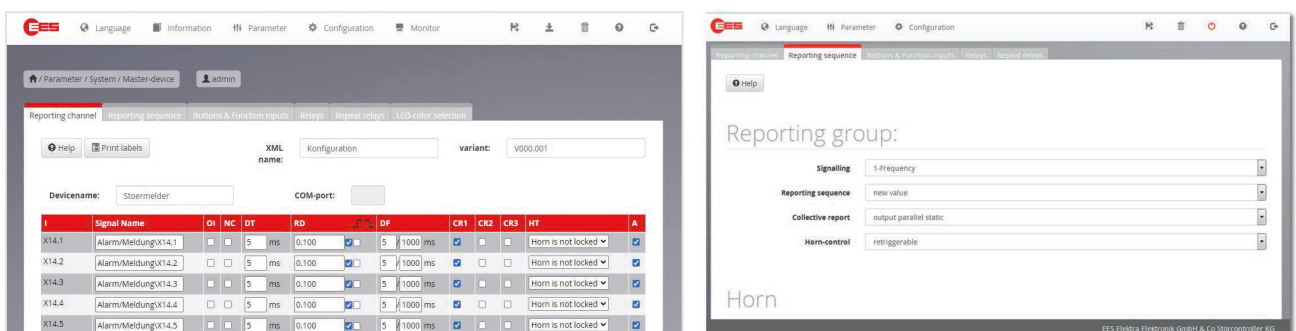

1. Channel-specific parameters (separate setting possible for each signalling channel)

- Signal name (labelling)
- Operation indication (status indication) or fault annunciation
- NO- or NC-principle for each signal input
- Debouncing delay
- Alarm delay
- Defluttering
- Assignment to collective reports 1, 2 or 3
- Horn triggering
- Colour for displaying status or alarm

2. Alarm sequence (can be composed of the following components)

- First-up or no-first-up alarm
- 1- or 2-frequency-flashing or status indication

3. Horn triggering

Function	Option	Description
Internal horn	Active	Internal horn is activated.
	Inactive	Internal horn is deactivated.
Horn triggering	Retriggerable	Horn is triggered by subsequent alarm, even if there are already alarms at issue.
	Not retriggerable	Horn is triggered by subsequent alarms only if no alarms are at issue.
Horn lock	Inactive	Horn can always be acknowledged.
	Active	Horn can only be acknowledged once the alarm has been acknowledged.
Horn priority acknowledge	Inactive	Alarm can always be acknowledged
	Active	Horn must be acknowledged first prior to the alarm input
Horn acknowledge	Manual (continuous tone)	Horn is acknowledged manually by button or function input.
	Automatic (pulse tone)	Horn is acknowledged automatically according to the set time.

4. Unmanned operation

Function	Effects
Mute function (Mute)	The horn is not triggered or automatically acknowledged after a parameterizable time if a button or a parameterized functional input is pressed or to set the function active.
Unmanned operation (Unmanned)	The fault annunciators can be switched between manned and unmanned station operating modes. In unmanned station mode, LEDs for displaying the messages are switched off and the alarm acknowledgement on the fault annunciator is deactivated at all.

5. Forming of collective reports

Function	Procedure
static / input-parallel	The collective report is set with the first incoming alarm and resets with the last receding alarm.
static / output-parallel	The collective report is set with the first incoming alarm. Once all alarms have receded and been acknowledged the collective report is reset.
static / dynamic / input-parallel	The collective report is set with the first incoming alarm. For each subsequent alarm, the collective report is reset for approx. 0.8 s and then set again. Once all alarms have receded the collective report is reset permanently.
static / dynamic / output-parallel	The collective report is set with the first incoming alarm. For each subsequent alarm, the collective report is reset for approx. 0.8 s and then set again. Once all alarms have receded and been acknowledged the collective report is reset permanently.
dynamic	The collective report is activated for approx. 0.8 s with each incoming alarm.
static / input-parallel / resettable	The collective report is set with the first incoming alarm and resets with the last receding alarm or when acknowledged.
static / output-parallel / resettable	The collective report is set with the first incoming alarm and reset independently from the state of the alarms by acknowledgement.

6. Buttons and functional inputs

The following functionalities are assignable for the **4 buttons and 2 functional inputs**. Multiple assignments are possible:

- Acknowledgment lamps Group*) 1,2, 3 or unassigned alarms
- Reset Group*) 1, 2, 3 or unassigned alarms
- Acknowledgement Horn
- Lamptest
- Function test
- Mute function
- Unmanned operation

A group is formed by all messages which are included in the same collective report. Unassigned inputs are those alarms that are not assigned to a collective report.

7. Functional relays

3 of the in total 4 functional relays can be assigned with functions. The 4th relay is fixed designed as a live relay. Multiple assignments are possible:

- Collective report 1,2 or 3
- Triggering of an external horn
- Control of relays by a functional input (1 or 2)
- Triggering through one of the buttons 1 ... 4
(statically, as long as a button is pressed or as a bistable relay, toggles on each pressing of a button)
- Inversion of the relay function is possible

8. Modbus Interface

The BSM-P can optionally be equipped with a Modbus-RTU interface. The serial connection is either RS232 or RS485. The BSM-P is a Modbus slave and can transmit states via the interface to higher-level control systems as well as be controlled by third-party devices, provided these act as Modbus masters.

➔ **Parameter-Import from Excel**

In addition to the manual parameterisation as described in the last sections, the alarm specific settings can also be imported from Excel.

EES provides a template that can be filled in and processed with common procedures in order to save time and reduce causes of failure during the parameterisation process.

1	Index	Geräte- nummer	Eingang	Beschriftung1	Beschriftung2	Betriebs- meldung	Ruhe- strom	Ansprech- verzögerung	Melde- verzögerung	kommend	gehend	Flutter- anzahl	Flutter- zeit	Sammel1	Sammel2	Sammel3	Hupe keine
2	idx	device number	input	signal name1	signal name2	operation	normally closed	debounce time	response delay	edge rising	edge falling	deflutter number	deflutter time	collective report1	collective report2	collective report3	horn not active
3	1	0	1	Alarm/Meldung	X20.8	x		5	0.100	x		5	1000	x			
4	2	0	2	Alarm/Meldung	X20.7		x	5	30	x	x	5	1000	x			
5	3	0	3	Alarm/Meldung	X20.6	x		5	0.100	x		5	1000	x			
6	4	0	4	Alarm/Meldung	X20.5			5	0.100	x		5	1000	x			
7	5	0	5	Alarm/Meldung	X20.4	x		5	0.100	x		5	1000	x			
8	6	0	6	Alarm/Meldung	X20.3			5	0.100	x		5	1000	x			
9	7	0	7	Alarm/Meldung	X20.2	x		5	0.100	x		5	1000	x			
10	8	0	8	Alarm/Meldung	X20.1			5	0.100	x		5	1000	x			
11	9	0	9	Alarm/Meldung	X18.8	x		5	30	x	x	5	1000	x			
12	10	0	10	Alarm/Meldung	X18.7			5	0.100	x		5	1000	x			
13	11	0	11	Alarm/Meldung	X18.6	x		5	0.100	x		5	1000	x			
14	12	0	12	Alarm/Meldung	X18.5			5	0.100	x		5	1000	x			
15	13	0	13	Alarm/Meldung	X18.4	x		5	0.100	x		5	1000	x			
16	14	0	14	Alarm/Meldung	X18.3		x	5	0.100	x		5	1000	x			
17	15	0	15	Alarm/Meldung	X18.2		x	5	0.100	x		5	1000	x			
18	16	0	16	Alarm/Meldung	X18.1		x	5	0.100	x		5	1000	x			
19	17	0	17	Alarm/Meldung	X16.8		x	5	0.100	x		5	1000	x			
20	18	0	18	Alarm/Meldung	X16.7			5	0.100	x		5	1000	x			
21	19	0	19	Alarm/Meldung	X16.6			5	0.100	x		5	1000	x			
22	20	0	20	Alarm/Meldung	X16.5			5	0.100	x		5	1000	x			
23	21	0	21	Alarm/Meldung	X16.4			5	0.100	x		5	1000	x			
24	22	0	22	Alarm/Meldung	X16.3			5	0.100	x		5	1000	x			
25	23	0	23	Alarm/Meldung	X16.2			5	0.100	x		5	1000	x			
26	24	0	24	Alarm/Meldung	X16.1			5	0.100	x		5	1000	x			
27	25	0	25	Alarm/Meldung	X14.8			5	0.100	x		5	1000	x			
28	26	0	26	Alarm/Meldung	X14.7			5	0.100	x		5	1000	x			
29	27	0	27	Alarm/Meldung	X14.6			5	0.100	x		5	1000	x			
30	28	0	28	Alarm/Meldung	X14.5			5	0.100	x		5	1000	x			
31	29	0	29	Alarm/Meldung	X14.4			5	0.100	x		5	1000	x			

➔ **Cascading**

With the cascading functionality up to four devices can be grouped to an annunciating system by connecting the devices via the systembus provided at the CAN-Bus sockets. One device works as “master” and the connected devices work as “slave”. Thus systems with up to 192 signal inputs (4*48) can be realized. Thus, the connected devices will be processing as a virtual compound annunciator with common signalling (alarm sequence, forming of collective reports and horn triggering).

Acknowledgement as well as output of the collective reports and horn triggering can arbitrarily be assigned to any of the buttons or relays respectively of the compound system. As slave devices within a cascaded system, annunciators of the type BSM-C or BSM-P can be used. MSM-relay-modules cannot be connected to cascaded annunciators.

Basic structure of a cascaded fault annunciating system

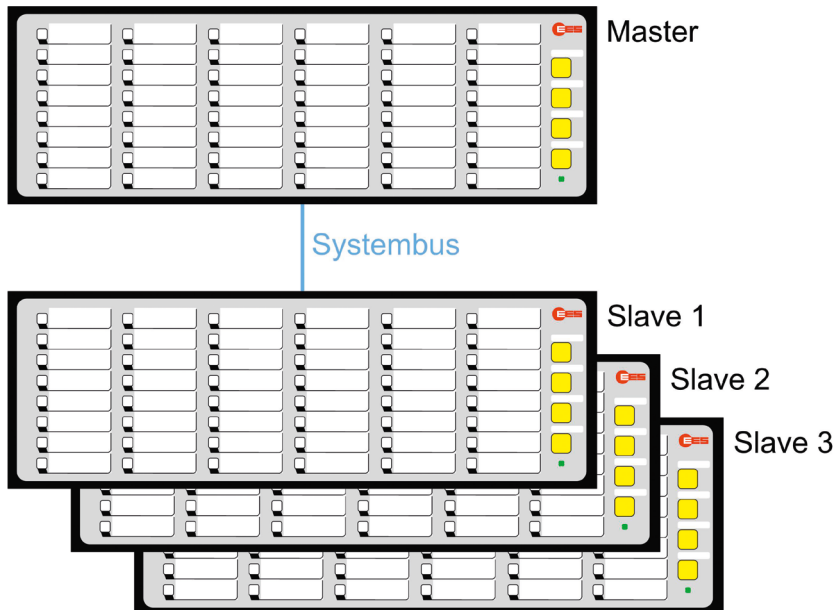

 The parameterisation is done completely via the browser-based software. The parameter adjustment of cascaded fault annunciator devices is only carried out completely in the "Master fault annunciator" and is then automatically distributed to the "Slave fault annunciator". Due to the cascading, the number of function inputs is multiplied according to the number of units. A maximum of 8 function inputs are available.

→ USM: Universal annunciator with protocol interfaces

The USM resembles the BSM-P in general functionality. For communication with superior or inferior systems (e.g. SCADA) the USM is equipped with one or two communication cards. The communication cards provide the following interfaces:

Card 1 (equipped as standard)

- 1 x LAN - Ethernet / RJ45 (Protocol interface as well as diagnostic and parameterisation)
- 1 x COM - RS232 / pluggable terminal (Serial protocol interface)
- 2 x USB-A (factory interface)
- 1 x CAN-Bus / RJ45 (System bus for connecting expansion modules or setting-up alarm cascades see also section Cascading)
- 1 x USB-B (Diagnostic interface)

Card 2 (optionally equipped)

- 1 x LAN - Ethernet / RJ45 (Protocol interface as well as diagnostic and parameterisation) alternatively optical interface multimode 50-62.5 / 125 μm @ 1300 nm; Connector SC (according to standard IEC 60874-13) (protocol interface)
- 1 x COM - RS232 optionally RS 485 / pluggable terminal (Serial protocol interface)

Through these interfaces the annunciators can be connected to third party systems by use of the following protocols:

- Modbus RTU/TCP (annunciator is Modbus-slave)
- IEC 60870-5-101 (annunciator is IEC-slave)
- IEC 60870-5-104 (annunciator is IEC-server or client)
- IEC 61850 (annunciator is IEC-server)

▶ A fault annunciator with the IEC 60870-5-101/104 interface, which is operated as a server, can establish a connection to a maximum of 4 clients (Multilink). It is possible to combine several of the above mentioned protocols in one annunciator. For detailed information on the interfaces, please refer to the respective separate interface descriptions.

1. USM as acquisition device

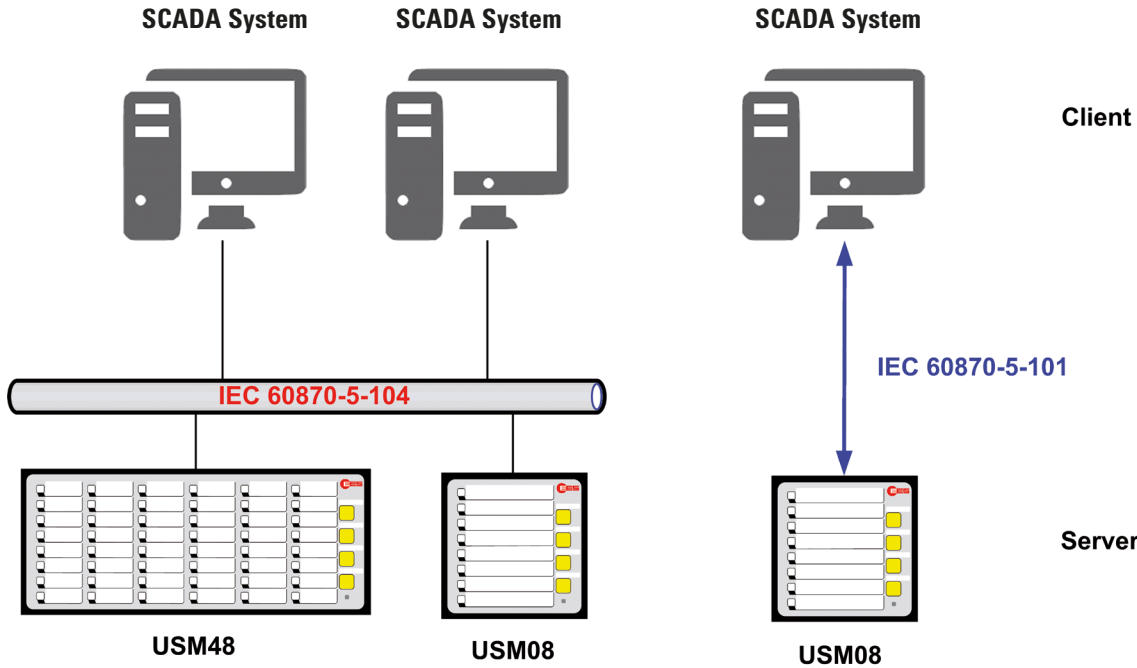

The diagram above shows an application example in which the USMs serve as acquisition modules, processes and signals the alarms on-site. In addition, the alarms are transferred to the control level via IEC 60870-5-101/104 interface.

▶ The signal channels can be controlled alternatively via galvanic input or IEC interface. Which of these two possibilities is used can be parameterized for each individual channel. Acknowledgement via IEC interface is also possible.

2. USM as indication device

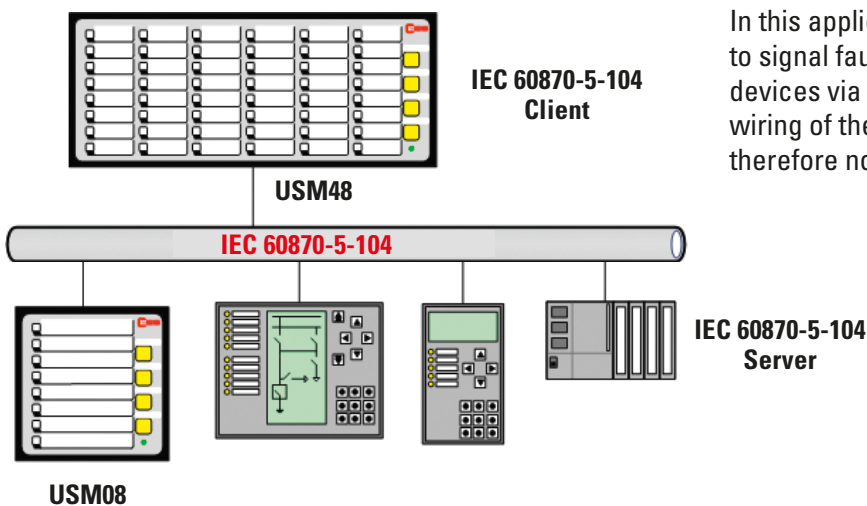

In this application example, the USM48 is used to signal faults that are "collected" by various devices via the IEC interface. An additional wiring of the individual fault alarm contacts is therefore not necessary.

3. Mirroring of single alarms

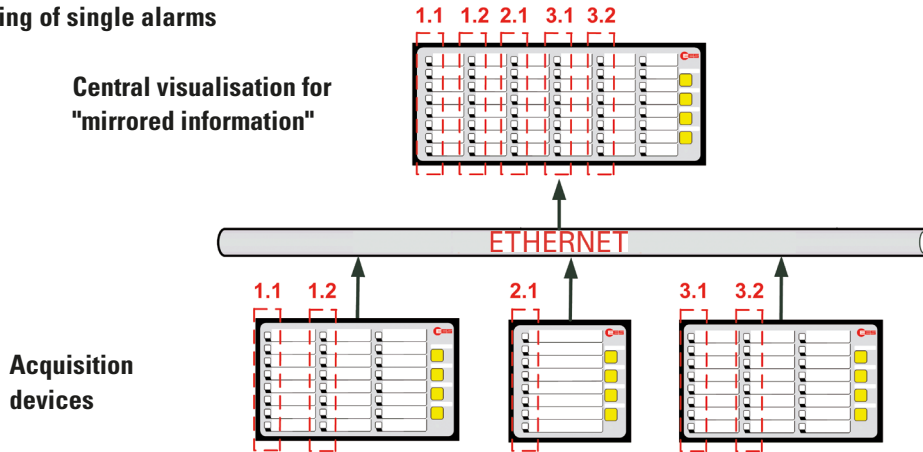

In larger plant areas and complex processes, important individual states from the field are often required at central points or control rooms. In classical systems, 1:1 relays are used, which means a high amount of wiring. With USM fault reporting systems this effort can be greatly reduced. 32 USM field stations can send and mirror single messages over a network connection (copper or optical fibre) to a central USM or another USM field station. The mirrored messages do not have to be individually wired or acknowledged "at the mirror", but are always in the state of the inputs of the triggering USM.

4. USM in IEC 61850 structures:

The IEC 61850 protocol is used in automated switchgear to transmit information from field and protective devices. In addition, various individual messages are generated which - depending on the type of message - must also be transmitted to the process control system or other devices at the field or station level.

With the aid of the optionally integrable IEC 61850 server, the fault annunciator of the USM series perform this "rag collector" function. Here individual messages, with the aid of the optional analog inputs and also measured values can be transmitted. Individual reports and datasets can be configured to provide all relevant information about the message and device status. In addition, the USM can be configured as 61850 watchdog for third-party devices. A configurable time is monitored during the external device must periodically report to the USM. If the time is exceeded, a freely assignable digital input is activated.

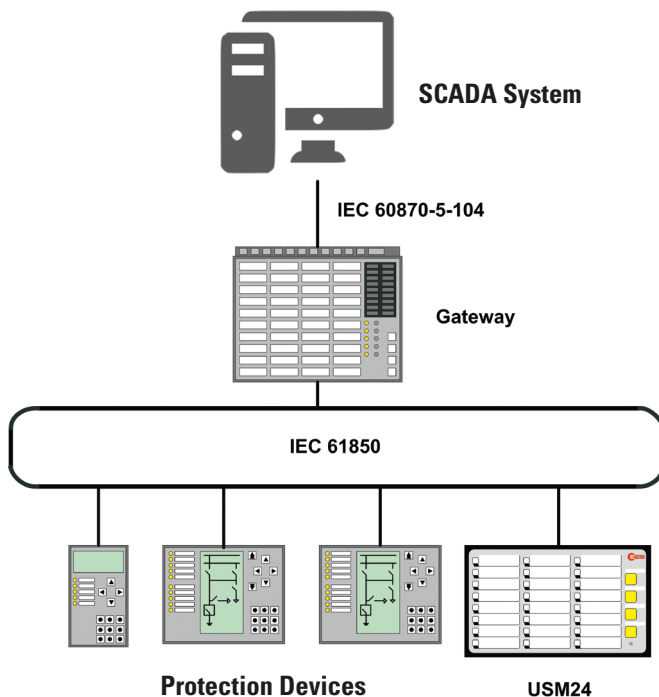

▶ With the optionally available software license IEC 61850 the USM can be integrated into IEC 61850 structures.

▶ The signal channels can be controlled alternatively via the galvanic input or the 61850 interface. Which of these two options is used for each individual channel can be parameterized. Acknowledgement via the 61850 interface is also possible.

5. CID-Creator

Every annunciator of the series USM provides numerous information about the status of the in- and outputs as well as the device status on the communication interface by default. Some applications require only a subset of the available information, e.g. on the IEC 61850 Bus. The CID-creator offers the possibility to select the information which is of interest in advance. Thus, the CID-file of the annunciator only contains the required and relevant information for the respective application. By creating the file, you can choose between editions 1.0, 2.0 and 2.1 of the IEC standard.

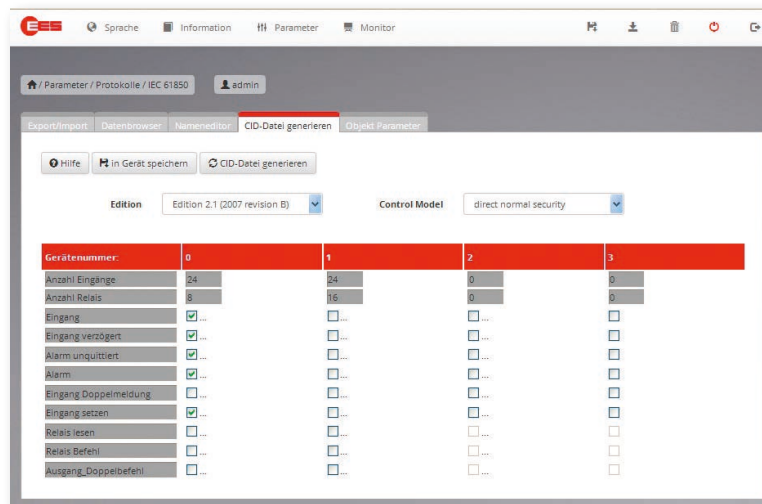

6. Integrated Web-Server

The USM has an integrated web server. The parameterisation can be done via network using all common web browsers. All fault message and interface parameters are available by web server and can be parameterised via it. Additional parameterisation software or special parameterisation cables are not required. Service access and an online monitor of the fault annunciator are also part of the functional scope of the web server.

7. Integrated logic functionality

The fault annunciators of the USM series offer integrated logic functionality.

This means that several inputs can be OR-linked with each other as required to control a dedicated fault message channel. In total, up to 192 alarms (4*48, maximum configuration of a cascaded fault annunciating systems) can serve as inputs for the logic function. A maximum of 16 group alarms can be controlled from the logic function. The parameterisation of the message links can be carried out easily and clearly using an Excel template.

8. IP Security

For the companies in the energy industry, a white paper with basic security measures for control and telecommunication system management was developed. The goal is to adequately protect the systems against security threats in daily operations. This optional "IP Security" feature is designed to meet these requirements. For this the following functions were added or extended:

- Password management
- Firewall settings
- Certificate administration
- File transfer via SFTP (Secure File Transfer Protocol)
- Communication using HTTPS (Hypertext Transfer Protocol Secure)

→ Labelling

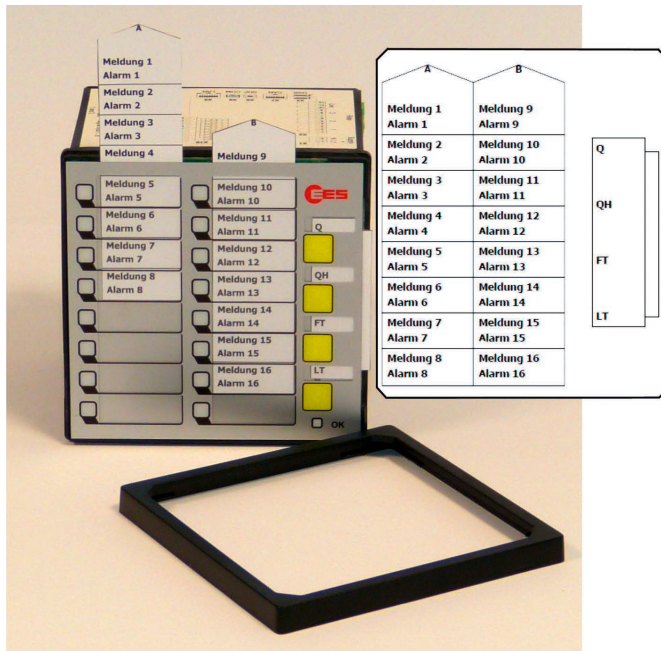

Labelling of the annunciator is done by means of designation strips that can be inserted beneath the cover foil after removing the front frame.

The designation strips with signal names can be created and printed directly from the parameterisation interface or generated manually from labelling strips in Word-format.

→ Available Options

The annunciators can be equipped with the following available options:

1. Redundant power-supply

Independent from the primary power supply of the device a second, redundant power supply can be integrated into the fault annunciator. Two different voltage variants are available:

- 24 – 60 V AC/DC
- 110 – 220 V AC/DC

The voltage level of the redundant power supply can be chosen independently from the voltage level of the primary power supply. Both primary and redundant power supplies are included in the self-monitoring of the annunciator and any malfunctions are signaled on the watchdog-contact and the OK-LED. Additionally the application of the supply voltage for both power supplies is indicated by a LED each on the rear side of the device. For the annunciators of the series USM the breakdown of a power supply is also transmitted on the communication interface.

2. Additional feature cards

Analog input cards and relay cards can optionally be integrated into the fault annunciator. The mixed use of analog input and relay cards is also possible. The possible combinations can be found in the matrix with the ordering designations further back in the data sheet.

2.1 Analog Inputs Cards (only available at USM)

Depending on the size of the devices, a USM can be equipped with up to 5 analog input cards. Each input card has 4 analog inputs that have a common reference ground. One input can be configured as voltage or current input, depending on the application. The following options are available:

- 0 ... 10 V
- -10 ... 10 V
- 0 ... 20 mA
- 4 ... 20 mA (with wire break monitoring in the fault annunciator)

The measured values can be forwarded to a higher-level system via the Modbus, IEC 60870-5-101/104 or the IEC 61850 interface. Furthermore, the measured values can be monitored and an alarm can be generated in case of a fault.

The alarm can be parameterized with a trigger by one of the following events:

- if the value exceeds the limit value
- if the value falls below the limit value
- if the measured value is within a range
- if the measured value is outside a range

2.2 Internal relay-cards

The optionally integrated relay cards (8 NO contacts each) are independent from the 4 function relays of the annunciator and can – dependent of the annunciator version – be used for the following functions:

1. In- or output-parallel multiplication and forwarding of single alarms within the annunciator without connection of external MSM-modules
2. Output of the collective report or external horn triggering
3. Triggering of the relays from the IEC-interface (only available for USM)

The assignment of the relays depends from the version of the respective annunciator:

- BSM-C -assignment of repeat relays 1:1 to signal inputs
- BSM-P -assignment of repeat relays to signal inputs individually parameterisable
- USM -individual parameterisation which input triggers the relay or if the relay is triggered from the IEC-interface

The eight relays each of a relay card have a common root. The control and functionality of the relays can be individually adjusted for each fault annunciator using the parameterisation software or via the web server. It can be freely chosen which input the respective relay follows, the assignment can be done 1: 1 (one relay follows an input) or n: 1 (several relays follow one input). It is also possible to output special functions such as horn activation or the output of a collective report to the 1: 1 relay. In addition, other parameters are available, e.g. inversion of the signals and the wiping time for pulse output.

Available variants:



BSM 08 with 8 relays
 USM 08 with 8 relays
 USM 08 with 4 analog inputs

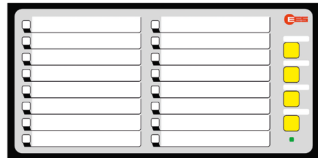

BSM 16 with 8 or 16 relays
 USM 16 with 8 or 16 relays
 USM 16 with 4 or 8 analog inputs
 USM 16 with 4 analog inputs and 8 relays



BSM 24 with 8, 16 or 24 relays
 USM 24 with 8, 16 or 24 relays
 USM 24 with 4, 8 or 12 analog inputs
 USM 24 with 4 analog inputs and 8 relays
 USM 24 with 8 analog inputs and 8 relays
 USM 24 with 8 analog inputs and 16 relays

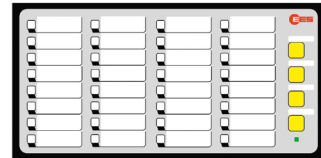

BSM 32 with 8 or 16 relays
 USM 32 with 8 or 16 relays
 USM 32 with 4 analog inputs
 USM 32 with 8 analog inputs
 USM 32 with 4 analog inputs and 8 relays

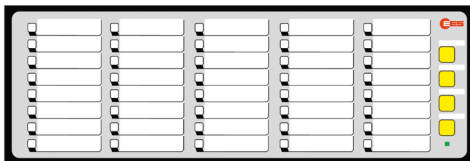

BSM 40 with 8, 16 or 40 relays
 USM 40 with 8, 16 or 40 relays
 USM 40 with 4 or 8 analog inputs
 USM 40 with 4 or 8 analog inputs
 USM 40 with 4 analog inputs and 8 relays
 USM 40 with 20 analog inputs

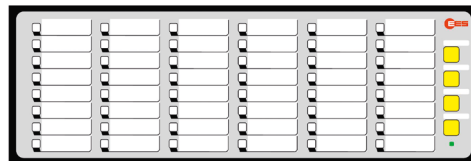

BSM 48 with 8 or 16 relays
 USM 48 with 8 or 16 relays
 USM 48 with 4 or 8 analog inputs
 USM 48 with 4 analog inputs and 8 relays

The maximum number of additional cards that can be integrated into a fault annunciator (analog cards or relay cards and second interface card) is defined as follows:

BSM / USM 08	1 Additional feature card, Interface card not available
BSM / USM 16 (wide housing)	2 Additional feature card + 1 Interface card
BSM / USM 24	3 Additional feature card + 1 Interface card
BSM / USM 32	2 Additional feature card + 1 Interface card
BSM / USM 40	5 Additional feature card + 1 Interface card
BSM / USM 48	2 Additional feature card + 1 Interface card

If you have any questions, please do not hesitate to contact our service team.



BSM 16 and USM 16 with additional cards are supplied in a wide housing with front frame size (H x W [mm] 96 x 192). If you have any questions, our service team will be happy to assist you.

→ Technical Data

Supply voltage U_{Sup}

Key	Rated voltage	Voltage range
1	24 V AC/DC	19...37 V DC or 14...26 V AC
2	48 V AC/DC or 60 V DC	37...73 V DC or 26...51 V AC
5	110 V AC/DC or 220 V AC/DC	85...370 V DC or 85...264 V AC

Signal voltage U_{Sig}

Key	Rated voltage [V AC/DC]	Treshold for alarm		Maximum permitted voltage [V AC/DC]	Input current per input @ rated voltage [mA]
		Inactive [V AC/DC]	Active [V AC/DC]		
1	24	11	15	50	2,3
3	48	17	25	75	2,1
	60	17	25	75	2,7
E	60	42	54	75	1,6
4	110	35	50	150	1,6
H	125	35	50	150	1,8
5	220	100	140	260	1,2
W	50 - 250	25	45	250	1,6

If not otherwise specified the given information for alternating voltage are referring to a sinusoidal alternating voltage with a frequency of 50/60 Hz

Analog Inputs

Resolution	12 Bit
Measuring tolerance from measuring range end value	$T_{\text{amb}} = -20...60\text{ °C}: \leq \pm 0,5\%$

Voltage Inputs

Measuring range (U_{DIFF})	-10...+10 V (SELV, PELV)
Overvoltage strength	$\pm 26\text{ V}$
Input resistance (U_{DIFF})	$\geq 200\text{ k}\Omega$
Measuring value resolution	$\leq 5\text{ mV}$
Common mode voltage (U_{COM})	-10...+10V

Electrical Inputs

Measuring range (I_{DIFF})	0...20mA (SELV, PELV)
Overvoltage strength	$\pm 10\text{ V}$
Input load	$\leq 100\ \Omega$
Measuring value resolution	$\leq 5\ \mu\text{A}$
Common mode voltage (U_{COM})	-0,2...+0,2 V

Relay contact

Load capacity	24 ... 250 V AC 2 A; 110 V DC 0,5 A; 220 V DC 0,3 A
---------------	---

Power consumption

Number of channels	Power consumption [W]			
	BSM	BSM with integrated repeat relays	USM	USM with integrated repeat relays
8	< 4	< 6	< 8	< 10
16	< 5	< 9	< 9	< 13
24	< 5	< 13	< 10	< 17
32	< 6	< 11	< 10	< 15
40	< 7	< 19	< 11	< 24
48	< 8	< 13	< 12	< 17

→ Technical Data

General Data

Backup time for	
Failure / short circuit	100 ms
Response delay BSM-C	100 ms
Response delay BSM-P, USM	configurable (5 ms ... 9 h)
Flashing frequency	
flashing	2 Hz
slow flashing	0,5 Hz
Load capacity of the relay contacts	24 ... 250 V AC 2 A; 110 V DC 0,5 A; 220 V DC 0,3 A
Ethernet connection (USM only)	100 Base-T / RJ45
Optical fibre-connection (optional USM)	Multimode 50-62,5/125 µm @1300 nm; Connector SC-duplex according to standard IEC 60874-13

Mechanical Data

Typ BSM/USM	Front frame H x W x D [mm]	front panel [mm]	Depth with front frame and terminals [mm]	Weight [kg]
08	96 x 96 x 8	92 x 92	100	approx. 0,40
16	96 x 96 x 8	92 x 92	100	approx. 0,45
16 Wide-housing 24 and 32	96 x 192 x 8	92 x 186	100	approx. 0,70
40 48	96 x 287 x 8	92 x 282	100	approx. 1,00

Mounting	panel mounting
Required installation depth	120 mm
Minimum horizontal gap	
between 2 devices	15 mm
Connection terminals	pluggable
Wire cross section rigid or flexible	
Without wire sleeves	0,2 ... 2,5 mm ²
With wire sleeves	0,25 ... 2,5 mm ²

Ambient environment

Operating ambient temperature	-20°C +60°C
Storage temperature	-20°C +70°C
Duty cycle	100 %
Protection class at the front	IP 54
Protection class at the rear	IP 20
Humidity	75% r.h. max. on average over the year; up to 93% r.h. during 56 days; condensation during operation not permitted [Test: 40°C, 93% r.h. > 4 days]

→ Technical Data

Electrical Data

voltage dielectric strength

withstand power frequency voltage strength

Digital inputs	4 kV AC / 50 Hz 1 min
Analog inputs	1kV AC / 50Hz 1min (functional insulation)
Relay contacts	4 kV AC / 50 Hz 1 min
Supply (110 / 230V AC/DC)	3,0 kV AC / 50 Hz 1 min
Supply (12 / 24 / 48 V AC/DC)	1,0 kV AC / 50 Hz 1 min
Relay contacts against each other	500 V / 50 Hz 1 min

Surge withstand strength

RS232/RS485 against	
Digital inputs	2,5 kV ; 1,2 / 50 µs; 0,5 J; acc. to IEC60255-5:2000
Relay contacts	2,5 kV ; 1,2 / 50 µs; 0,5 J; acc. to IEC60255-5:2000
Supply	2,5 kV ; 1,2 / 50 µs; 0,5 J; acc. to IEC60255-5:2000
Relay contacts against each other	500 V ; 1,2 / 50 µs; 0,5 J; acc.to IEC60255-5:2000

Electromagnetic Compatibility

Noise immunity acc. to	DIN EN 61000-4-2
	DIN EN 61000-4-3
	DIN EN 61000-4-4
	DIN EN 61000-4-5
	DIN EN 61000-4-6
	DIN EN 61000-4-8
	DIN EN 61000-4-11
	DIN EN 61000-4-12
Noise irradiation acc. to	DIN EN 61000-3-3
	DIN EN 55011



The devices are designed and manufactured for industrial applications according to EMC-standard.



Terminal assignment

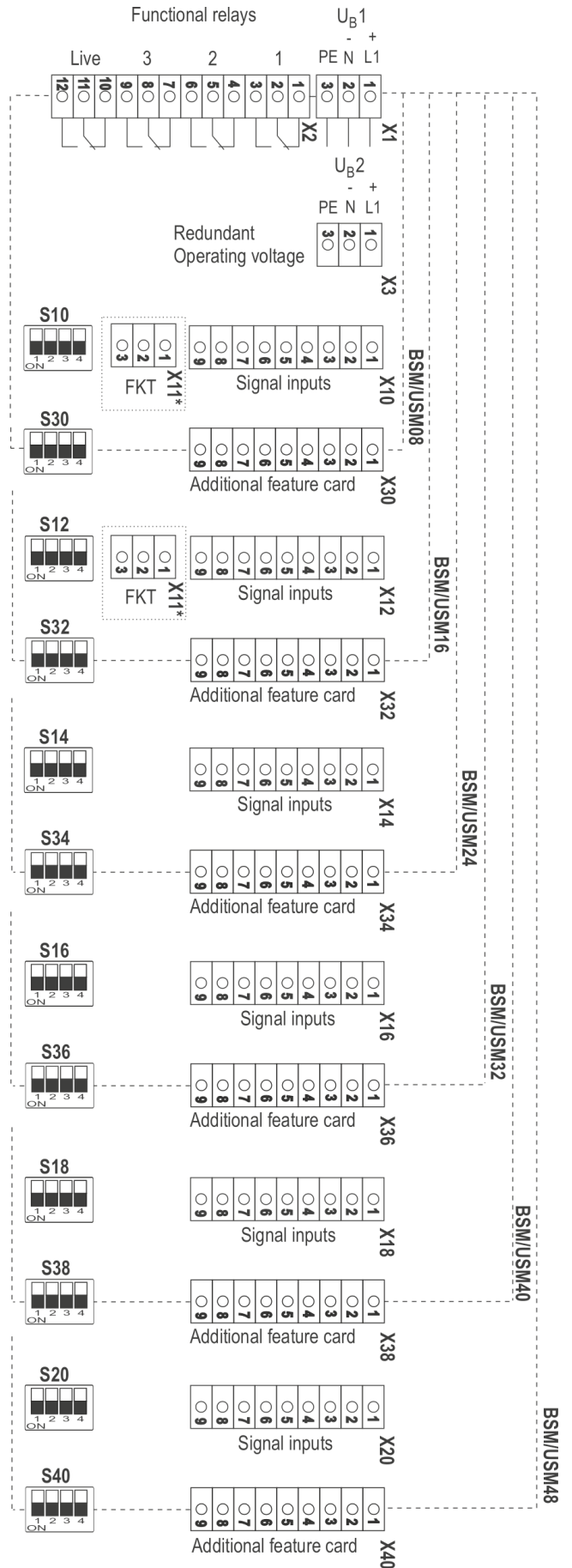

Interfaces / switches



1. Interface card (default)

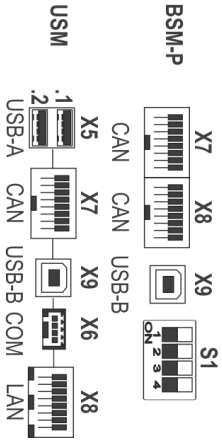

* Terminal X11 - Function Inputs (FKT) is located BSM/USM08 under Terminal X10 BSM/USM16 - 48 under Terminal X12

Assignment of relays (Factory default)

- Relay 1: All collective reports / all groups
- Relay 2: Not assigned
- Relay 3: Horn
- Relay 4: Live contact

Assignment of input terminal and alarm inputs on the front panel

The first input of the input terminal with the highest designation is always the first alarm at the top left of the display on the front panel (e.g. BSM48 - X20, 1).

2. Interface card (Option)

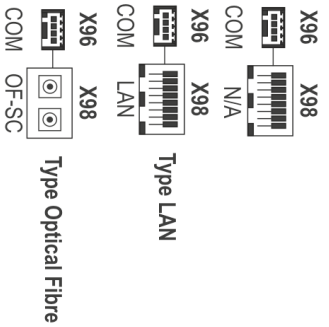

Assignment COM as RS232

- 1 - Screen (optional)
- 2 - RX
- 3 - TX
- 4 - GND

Assignment COM as RS485

- 1 - Screen (optional)
- 2 - A
- 3 - B
- 4 - GND

The CAN bus sockets X7 and X8 provide a system bus for expansion modules or for setting up cascaded fault indication systems.

The DIP switches S30 - S38 are only included on relay cards. If these are not available, the corresponding DIP switches are also omitted. The USM is only parameterized via the internal web server and therefore has no DIP switches.

➔ Detailed terminal assignment

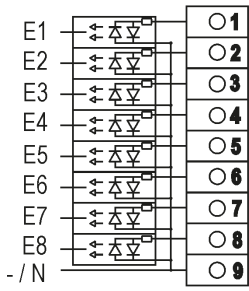

Signal Inputs

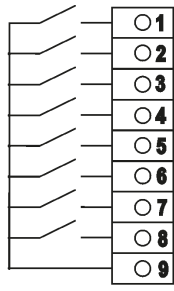

Relay Outputs

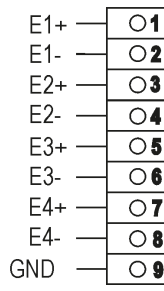

Analog Inputs

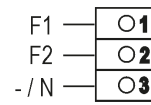

Function Inputs

➔ Front and back views

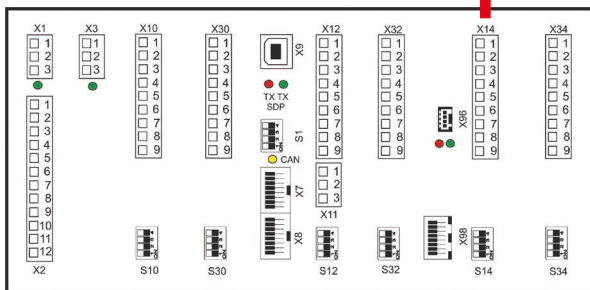
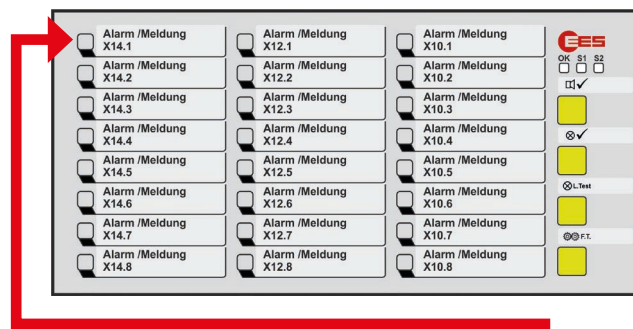
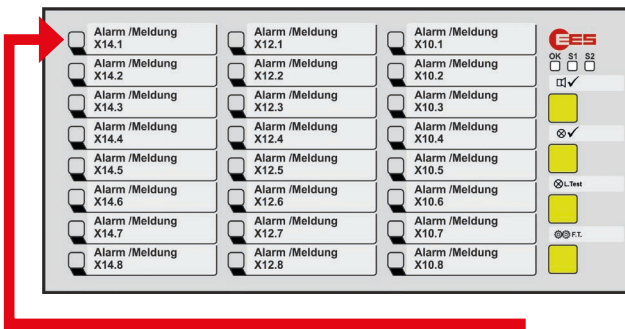

BSM 24

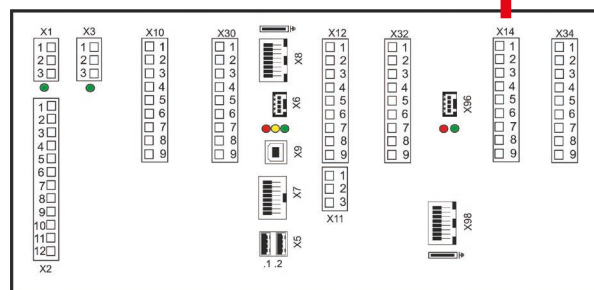

USM 24

Assignment of input terminals and alarms on the front panel

The first input of the input terminal with the highest designation is always the first message in the upper left corner of the LED display on the front panel. In the example above, this is X14.1.



The rear views of the devices are only shown as examples. Some of the visible connectors and indicators are only available if the corresponding optional features are available. For more detailed information, please refer to the corresponding operating manuals.



→ Terminal assignment of the annunciator variants

Depending on the configuration of the fault annunciator, optional additional feature cards in the versions 4 analog inputs or 8 relay outputs can be integrated into the fault annunciator in addition to the signal input cards. Analog input cards have blue terminals for better differentiation. The following table shows the possible versions of the fault annunciator and the respective assignment of the terminal blocks.

- E - Alarm inputs
- R - Relay outputs
- A - Analog inputs
- Blank - Terminal block not available

Type	Alarm inputs						Additional feature cards					
	X10	X12	X14	X16	X18	X20	X30	X32	X34	X36	X38	X40
BSM/USM-08...0	E											
BSM/USM-08...R	E						R					
USM-08...A	E						A					
BSM/USM-16...0	E	E										
BSM/USM-16W...1	E	E						R				
BSM/USM-16W...R	E	E					R	R				
USM-16W...3	E	E						A				
USM-16W...A	E	E					A	A				
USM-16W...5	E	E					A	R				
BSM/USM-24...0	E	E	E									
BSM/USM-24...1	E	E	E						R			
BSM/USM-24...2	E	E	E					R	R			
BSM/USM-24...R	E	E	E				R	R	R			
USM-24...3	E	E	E						A			
USM-24...4	E	E	E					A	A			
USM-24...5	E	E	E					A	R			
USM-24...6	E	E	E				A	R	R			
USM-24...7	E	E	E				A	A	R			
USM-24...A	E	E	E				A	A	A			
BSM/USM-32...0	E	E	E	E								
BSM/USM-32...1	E	E	E	E						R		
BSM/USM-32...2	E	E	E	E					R	R		
USM-32...3	E	E	E	E						A		
USM-32...4	E	E	E	E					A	A		
USM-32...5	E	E	E	E					A	R		
BSM/USM-40...0	E	E	E	E	E							
BSM/USM-40...1	E	E	E	E	E						R	
BSM/USM-40...2	E	E	E	E	E					R	R	
BSM/USM-40...R	E	E	E	E	E		R	R	R	R	R	
USM-40...3	E	E	E	E	E						A	
USM-40...4	E	E	E	E	E					A	A	
USM-40...5	E	E	E	E	E					A	R	
USM-40...A	E	E	E	E	E		A	A	A	A	A	
BSM/USM-48...0	E	E	E	E	E	E						
BSM/USM-48...1	E	E	E	E	E	E						R
BSM/USM-48...2	E	E	E	E	E	E					R	R
USM-48...3	E	E	E	E	E	E						A
USM-48...4	E	E	E	E	E	E					A	A
USM-48...5	E	E	E	E	E	E					A	R

Subject to technical changes without prior notice

➔ Ordering Code

BSM-C – Basic version

59	B	x	x	x	C	R	x	x	0	
										Number of Signal Inputs
		0	8							8 Signal Inputs
		1	6							16 Signal Inputs
		1	W							16 Signal Inputs wide-housing (96 x 192 mm) *
		2	4							24 Signal Inputs
		3	2							32 Signal Inputs
		4	0							40 Signal Inputs
		4	8							48 Signal Inputs
										Supply Voltage
				1						24 V AC/DC
				2						48 V AC/DC or 60 V DC
				5						110 - 220 V AC/DC
										Signal Voltage
					1					24 V AC/DC
					3					48 - 60 V AC/DC
					4					110 V AC/DC
					H					125 V AC/DC
					5					220 V AC/DC
					W					50 - 250 V AC/DC (wide range)
										LED-Colour configurable (red, green, yellow, orange, blue, white)
										Integrated Repeat-Relays
							0			no repeat relays
							R			8 repeat relays (for annunciator with 8 signal inputs)
							R			16 repeat relays (for annunciator with 16 signal inputs) *
							R			24 repeat relays (for annunciator with 24 signal inputs)
							R			40 repeat relays (for annunciator with 40 signal inputs)
										Redundant Power Supply
								0		no redundant power supply
								1		24 - 60 V AC/DC
								5		110 - 220 V AC/DC

59 B

--	--	--	--

 C R

--	--

 0 Ordering Code

* 16-fault annunciator with integrated relay outputs only available in wide housing (96 x 192 mm)

Example for ordering

59B1655CRR10 BSM with 16 signal inputs in wide-housing
 Supply voltage 220 V
 Signal voltage 220 V
 RGB-LEDs
 Repeat-relays
 Redundant power supply 24 – 60 V



BSM-P - Parameterisable Version

59	B	x	x	x	x	P	R	x	x	0	
											Number of Signal Inputs
		0	8								8 Signal Inputs
		1	6								16 Signal Inputs
		1	W								16 Signal Inputs Wide-housing (96 x 192 mm) *1
		2	4								24 Signal Inputs
		3	2								32 Signal Inputs
		4	0								40 Signal Inputs
		4	8								48 Signal Inputs
											Supply Voltage
					1						24 V AC/DC
					2						48 V AC/DC or 60 V DC
					5						110 - 220 V AC/DC
											Signal Voltage
						1					24 V AC/DC
						3					48 - 60 V AC/DC
						4					110 V AC/DC
						H					125 V AC/DC
						5					220 V AC/DC
						W					50 - 250 V AC/DC (wide range)
											LED-Colour configurable (red, green, yellow, orange, blue, white)
											Integrated Repeat-Relays
								0			no repeat relays
								R			8 repeat relays (for annunciator with 8 signal inputs)
								R			16 repeat relays (for annunciator with 16 signal inputs) *1
								R			24 repeat relays (for annunciator with 24 signal inputs)
								R			40 repeat relays (for annunciator with 40 signal inputs)
								1			8 repeat relays (independent from no. of signal inputs)*1
								2			16 repeat relays (independent from no. of signal inputs)*1 / *2
											Redundant Power Supply
									0		no redundant power supply
									1		24 - 60 V AC/DC
									5		110 - 220 V AC/DC
											Interface Modbus RTU
										0	none
										M	Interface Modbus RTU switchable RS232 or RS485

59 B P R Ordering Code

*1 16-fault annunciator with integrated relay outputs only available in wide housing (96 x 192 mm) and RGB-LEDs.
 *2 Option is only available for BSM with 16 signal inputs in wide-housing and with 24 - 48 signal inputs.

Example for ordering

59B1655PRR10 Parameterisable BSM with 16 signal inputs in wide-housing
 Supply voltage 220 V
 Signal voltage 220 V
 RGB-LEDs
 Repeat-relays
 Redundant power supply 24 – 60 V

For BSM with 32 and 48 input channels, the internal 1: 1 relay option "R" is not available. However, 1 or 2 relay cards can be integrated. The relays can be freely assigned to the inputs.

USM - Annunciators with communication interface

59	U	x	x	x	x	W	x	R	x	x	
											Number of Signal Inputs
		A									8 Signal Inputs
		B									16 Signal Inputs
		W									16 Signal Inputs Wide-housing (96 x 192 mm) *6
		C									24 Signal Inputs
		D									32 Signal Inputs
		E									40 Signal Inputs
		F									48 Signal Inputs
											Supply Voltage
			1								24 V AC/DC
			2								48 V AC/DC or 60 V DC
			5								110 - 220 V AC/DC
											Signal Voltage
				1							24 V AC/DC
				3							48 - 60 V AC/DC
				4							110 V AC/DC
				H							125 V AC/DC
				5							220 V AC/DC
				W							50 - 250 V AC/DC (wide range)
											Security options
					E						Basic version, no IT security functionality
					S						Security configuration, security functionality included
					P						Port Security, extended security configuration including option S *5
											Protocol Interface Card 1
						W					Modbus TCP + IEC60870-5-101/-104
						F					Modbus TCP + IEC60870-5-101/-104 + IEC 61850 *2
											Protocol Interface Card 2 *1 / *4
							0				not equipped
							W				Modbus RTU/TCP + IEC60870-5-101/-104
							L				Modbus RTU/TCP + IEC60870-5-101/-104, optical fibre-SC-plug
											LED-Colour configurable (red, green, yellow, orange, blue, white)
											Optional Feature Cards
							0				no repeat relays and no analog cards
							R				8 repeat relays (for annunciator with 8 signal inputs)
							R				16 repeat relays (for annunciator with 16 signal inputs) *1
							R				24 repeat relays (for annunciator with 24 signal inputs)
							R				40 repeat relays (for annunciator with 40 signal inputs)
							1				8 repeat relays (independent from no. of signal inputs) *1
							2				16 repeat relays (independent from no. of signal inputs) *1 / *4
							A				4 analog inputs (for annunciator with 8 signal inputs)
							A				8 analog inputs (for annunciator with 16 signal inputs) *1
							A				12 analog inputs (for annunciator with 24 signal inputs)
							A				20 analog inputs (for annunciator with 40 signal inputs)
							3				4 analog inputs (independent of the size of the fault annunciator) *1
							4				8 analog inputs (independent of the size of the fault annunciator) *1 / *3 / *4
							5				4 analog inputs + 8 repeat relays (independent of size of the fault annunciator) *3 / *4
							6				4 analog inputs + 16 repeat relays (for annunciator with 24 signal inputs)
							7				8 analog inputs + 8 repeat relays (for annunciator with 24 signal inputs)
											Redundant Power Supply
							0				no redundant power supply
							1				24 - 60 V AC/DC
							5				110 - 220 V AC/DC

59 U R Ordering Code

Ordering Code 59ZLICP61850 - License key for IEC 61850 communication (if ordered later)

- *1 16- fault annunciator with additional cards only available in Wide housing (96 x 192 mm). A maximum of 2 additional cards can be inserted.
- *2 Communication via IEC 61850 is only available on one network interface, regardless of the total number of interfaces of the fault annunciator.
- *3 Option for USM with 24 signal channels not available
- *4 Option for USM with 8 signal channels not available
- *5 Availability on request

Available accessories

MSM-RM

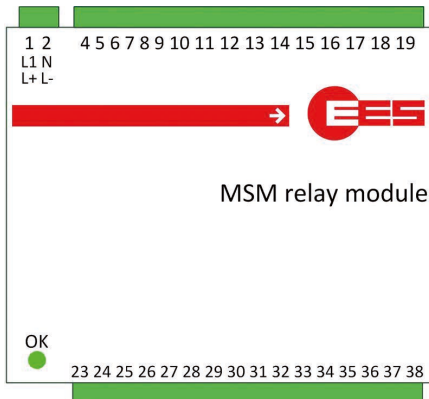

External relay modules for DIN-rail mounting can be connected to all BSM and USM devices in order to multiplicate signals. The relay modules are connected to BSM and USM annunciators via CAN-Bus. Please see our datasheet MSM-EM-DB-UK for full details.

Blind or frontplates for 19"-rack-mounting



In order to be able to use the fault annunciators of the BSM and USM series also in 19" systems, we offer a large number of blind and frontplates with different cut-outs for the installation of our fault annunciators.

We distinguish between:

- blind plates, which are attached to a 19" system instead of a subrack and
- front panels, which are integrated into an existing rack.

Adapter plate



Adapter plate for replacing a 96 x 144 front frame unit with a 96 x 96 front frame unit.

Ordering Code: 58ZFP211

DIN-Rail adapter

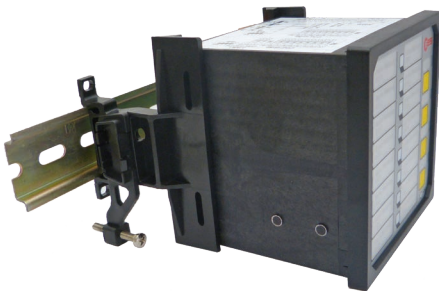

Adapter for mounting a panel-mounted fault annunciator on the DIN rail TH35

Ordering Code: 58ZMADA-DIN

Parameterisation accessories for BSM-P

Ordering Code: 59ZUSB20A-B

Parameterisation cable for connection of parameterizable BSM-P fault annunciator to the computer.
Type USB-A to USB-B.

Ordering Code: 97ZPSofPara

You can download our parameterisation software on our website www.ees-online.de.

Patch cable for cascading

For cascading several fault annunciator to one alarm system, connecting cables of different lengths are included in the delivery. If you require different cable lengths, please contact our service team.

Ordering Code:	K118-0.5	(0,5 m)
	K118-1	(1 m)
	K118-3	(3 m)
	K118-5	(5 m)



Our service team will gladly assist you in choosing the right accessories.

→ Contact