

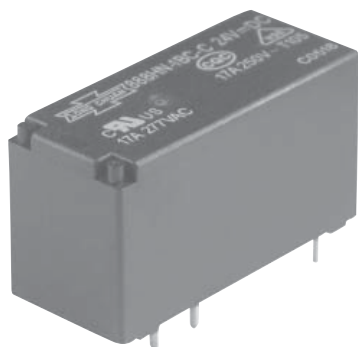

# 888



## »» Features



- High rating miniature PCB Relay.
- AC & DC coil are both available.
- UL/CUL and VDE approved.
- 17A 277VAC SPDT.
- 12A 277VAC DPDT.
- Low profile 15.7mm and high insulation Class F.
- High CTi 250 material & New Glow Wire Approved. (E Version)
- Special Version for inrush rating application is available (888-IT type)
- Comply with RoHS-Directive 2002/95/EC

## »» Type List

### ◆ Standard Type

Terminal style	Contact form	UL Insulation system approval	Designation (provided with)	
			Flux tight	Sealed type washable
PCB terminal	1A (SPNO)	F	888-1AC-F-C	888-1AC-F-S
			888-1AH-F-C	888-1AH-F-S
	1C (SPDT)	F	888-1CC-F-C	888-1CC-F-S
			888-1CH-F-C	888-1CH-F-S
	2A (DPNO)	F	888-2AC-F-C	888-2AC-F-S
			888-2AH-F-C	888-2AH-F-S
	2C (DPDT)	F	888-2CC-F-C	888-2CC-F-S
			888-2CH-F-C	888-2CH-F-S

### ◆ High Sensitivity Type (N) / Ultra-Sensitivity Type (N1)

PCB terminal	1A (SPNO)	F	888N-1AC-F-C	888N-1AC-F-S
			888N1-1AC-F-C	888N1-1AC-F-S
			888N-1AH-F-C	888N-1AH-F-S
			888N1-1AH-F-C	888N1-1AH-F-S
	1C (SPDT)	F	888N-1CC-F-C	888N-1CC-F-S
			888N1-1CC-F-C	888N1-1CC-F-S
			888N-1CH-F-C	888N-1CH-F-S
			888N1-1CH-F-C	888N1-1CH-F-S
	2A (DPNO)	F	888N-2AC-F-C	888N-2AC-F-S
			888N-2AH-F-C	888N-2AH-F-S
	2C (DPDT)	F	888N-2CC-F-C	888N-2CC-F-S
			888N-2CH-F-C	888N-2CH-F-S

### ◆ High Power Type

PCB terminal	1A (SPNO)	F	888H-1AC-F-C	888H-1AC-F-S
			888H-1AH-F-C	888H-1AH-F-S
	1C (SPDT)	F	888H-1CC-F-C	888H-1CC-F-S
			888H-1CH-F-C	888H-1CH-F-S



# 888

### ◆ High Power Type · High Sensitivity Type

PCB terminal	1A (SPNO)	F	888HN-1AC-F-C	888HN-1AC-F-S
			888HN-1AH-F-C	888HN-1AH-F-S
	1C (SPDT)	F	888HN-1CC-F-C	888HN-1CC-F-S
			888HN-1CH-F-C	888HN-1CH-F-S

Note : 888A—Special footprint 5.0mm pinning version can be selected

### ◆ Inrush Type (only for 0.53W)

PCB terminal	1A (SPNO)	F	888H-1AH-F-C IR	888H-1AH-F-S IR
	1C (DPDT)		888H-1CH-F-C IR	888H-1CH-F-S IR

### »» Ordering Information

888 H N1 - 1C C - F - C IR  
 1 2 3 4 5 6 7 8

- |          |   |          |   |
|----------|---|----------|---|
| 1. 888   | -- Basic series designation                 | 2B       | -- Double pole normally closed              |
|          |   | 2C       | -- Double pole double throw                 |
| 2. Blank | -- Standard type                            | 5. C     | -- Contact material AgNi                    |
|          | (1P - Terminal pitch 3.5mm)                 | CA       | -- Contact material AgNi + Au               |
|          | (2P - Terminal pitch 5.0mm)                 | H        | -- Contact material AgSnO                   |
| A        | -- Standard type and special terminal pitch | HA       | -- Contact material AgSnO+ Au               |
|          | (1P - Terminal pitch 5.0mm)                 |          |   |
| H        | -- High power type (only for 1P type)       | 6. Blank | -- Standard type                            |
| 3. Blank | -- Standard type                            | F        | -- Class F                                  |
|          | (DC: 0.53 W) (AC: 0.75 VA)                  | 7. C     | -- Flux tight                               |
| N        | -- High sensitivity type (0.40 W)           | S        | -- Sealed type washable                     |
| N1       | -- Ultra-sensitivity type (0.25 W)          | 8. Blank | -- Standard type                            |
|          | (only for 1P type)                          | IR       | -- 888 Inrush type (only for H · 1A/1 type) |
| 4. 1A    | -- Single pole normally open                | E        | -- CTI 250V                                 |
| 1B       | -- Single pole normally closed              |          |   |
| 1C       | -- Single pole double throw                 |          |   |
| 2A       | -- Double pole normally open                |          |   |

### »» Contact Rating

Type	1P			2P
	888 · 888N	888N1	888H · 888HN	888 · 888N
Rated load (resistive)	12A 240VAC	10A 240VAC	16A 240VAC	8A 240VAC
Max. switching current	12A	10A	17A	8A
Max. switching voltage	277VAC	277VAC	277VAC	277VAC
Max. switching capacity	2880VA	2400VA	4080VA	1920VA

### ◆ Inrush type

Tungsten Lamp	NO:1500W 240VAC 30,000 ops. (Inrush 110A)
Halogen Lamp	NO:1500W 240VAC 30,000 ops. (Inrush 110A)

## »» Coil Rating (DC)

### ◆ Standard Type

Rated voltage (V)	Rated current ±10 % at 23°C (mA)	Coil resistance ±10 % at 23°C (Ω)	Max. continuous voltage at 85°C	Pick up voltage(Max) at 23°C	Drop out voltage(Min) at 23°C	Power consumption at rated voltage
3	176	17	150 % of rated voltage	75 % of rated voltage	10 % of rated voltage	approx. 0.53W
5	106	47				
6	88	68				
9	59	153				
12	44	272				
15	35	425				
18	29	611				
24	22	1,087				
36	15	2,445				
48	11	4,347				

### ◆ High Sensitivity Type (N)

Rated voltage (V)	Rated current ±10 % at 23°C (mA)	Coil resistance ±10 % at 23°C (Ω)	Max. continuous voltage at 85°C	Pick up voltage(Max) at 23°C	Drop out voltage(Min) at 23°C	Power consumption at rated voltage
3	133	22.5	150 % of rated voltage	70 % of rated voltage	10 % of rated voltage	approx. 0.40W
5	80	62				
6	67	90				
9	44	203				
12	33	360				
18	23	771				
24	17	1,440				
36	11	3,240				
48	9	5,520				

### ◆ Ultra-Sensitivity Type (N1)

Rated voltage (V)	Rated current ±10 % at 23°C (mA)	Coil resistance ±10 % at 23°C (Ω)	Max. continuous voltage at 85°C	Pick up voltage(Max) at 23°C	Drop out voltage(Min) at 23°C	Power consumption at rated voltage
3	83	36	150 % of rated voltage	75 % of rated voltage	10 % of rated voltage	approx. 0.25W
5	50	100				
6	42	144				
9	28	324				
12	21	576				
18	14	1,296				
24	10	2,304				
36	7	5,184				



# 888

## »» Coil Rating (AC)

Rated voltage (V)	Rated current ±10% at 23°C (mA)	Coil resistance ±10% at 23°C (Ω)	Max. continuous voltage at 70°C	Pick up voltage(Max) at 23°C	Drop out voltage(Min) at 23°C	Power consumption at rated voltage
6	124	18.8	150 % of rated voltage	80 % of rated voltage	15 % of rated voltage	approx. 0.75VA
12	62.5	79.8				
24	31.2	334				
42	17.9	966				
48	15.5	1,340				
100/110	7.53	6,840				
110/120	6.8	7,360				
200/220	3.75	23,800				
220/240	3.4	27,400				

## »» Specification

Contact material	AgNi / AgSnO alloy	
Contact resistance <sup>(1)</sup>	100mΩ Max.	
Operate time <sup>(1)</sup>	20ms Max.	
Release time <sup>(1)</sup>	10ms Max.	
Insulation resistance <sup>(1)</sup>	1000MΩ Min. (DC 500V)	
Dielectric strength <sup>(1)</sup>	Between open contact	: AC 1000V, 50/60Hz 1 min.
	Between contact and coil	: AC 5000V, 50/60Hz 1 min.
	Between contact circuits	: AC 3000V, 50/60Hz 1 min. (for 2P DC type) AC 2500V, 50/60Hz 1 min. (for 2P AC type)
Surge voltage withstand	Between contact and coil : 10KV (1.2X50) μS	
Vibration resistance	Operating extremes	10 ~ 55Hz , amplitude 1.5 mm
	Damage limits	10 ~ 55Hz , amplitude 1.5 mm
Shock resistance	Operating extremes	10G
	Damage limits	100G
Life expectancy	Mechanical	30,000,000 operations (frequency 72,000 operations /hr) 5,000,000 operations (for 2P AC type) (frequency 18,000 operations /hr)
	Electrical	100,000 operations (frequency 360 operations /hr)
Operating ambient temperature	DC coil	-40 ~ +85°C (no freezing) <sup>(2)</sup>
	AC coil	-40 ~ +70°C (no freezing)
Weight	Approx. 10 g	

Note : (1) initial value

(2) special version of high temperature 105°C can be selected.

### »» Safety Approval

Certified	UL / CUL	VDE
File No.	E88991	40006746

### »» Safety Approval Rating (VDE)

◆ DC coil

◆ AC coil

888H、888HN	888、888N、888N1	888、888N	888H	888
	1P	2P		
17A 250VAC T105	12A 250VAC T105	12A 250VAC T85 10A 250VAC T105	17A 250VAC T85	1P: 12A 250VAC T85 2P: 10A 250VAC T85

### »» Safety Approval Rating (UL/CUL)

888 (1P)		888 (2P)	888N1
C、CA	H、HA		
NO/NC: 17A 277VAC NO: 12A 30VDC 1HP 480VAC NC: 1/2HP 120/240/480VAC	NO/NC: 17A 277VAC NO: 1HP 120/240/480VAC TV-8 NC: 12A 30VDC 1/2HP 120/240/480VAC	NO/NC: 12A 277VAC NO: 1/2HP 120/240VAC TV-5 (H、HA type only) NC: 1/3HP 120/240VAC	17A 277VAC 12A 30VDC

### »» Outline Dimensions

◆ 888 1P

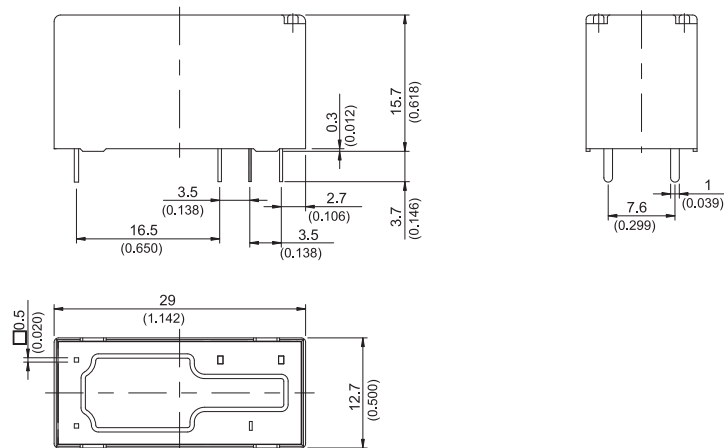

◆ 888H 1P

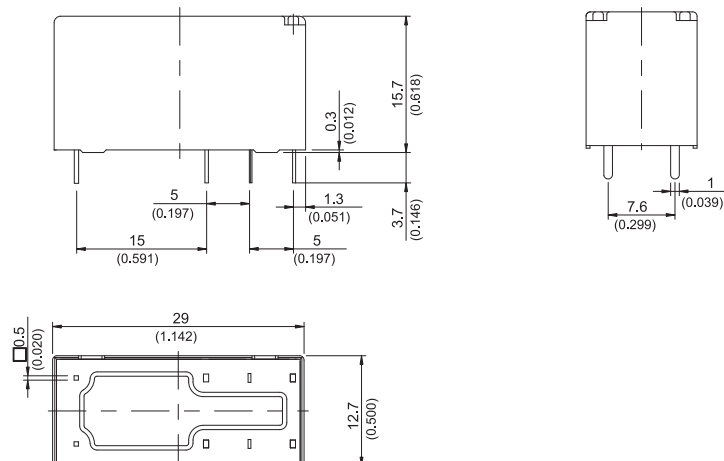



# 888

◆ 888 2P

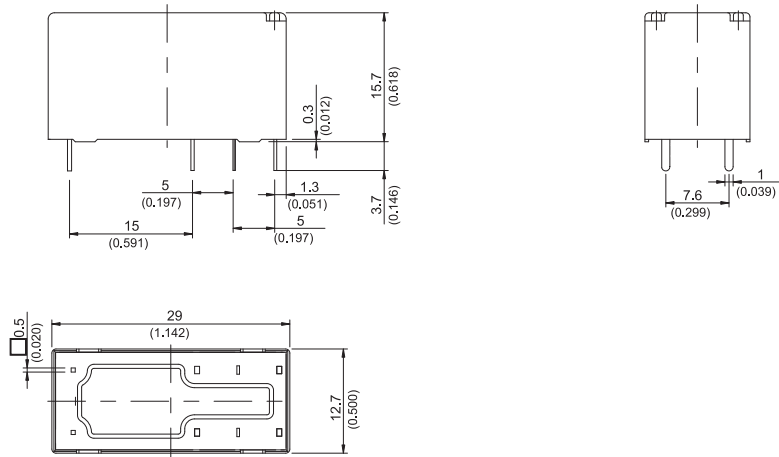

»» Wiring Diagram  
BOTTOM VIEW

◆ 888

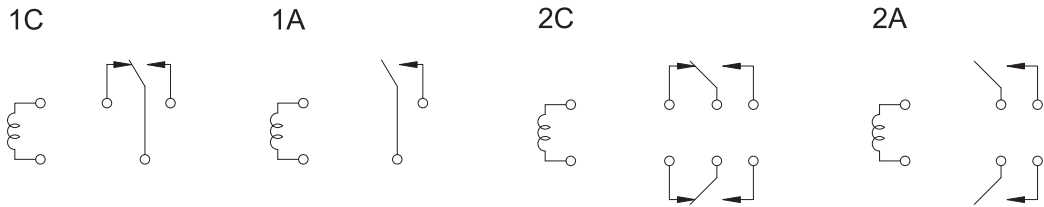

◆ 888H



»» PC Board Layout  
BOTTOM VIEW

◆ 888

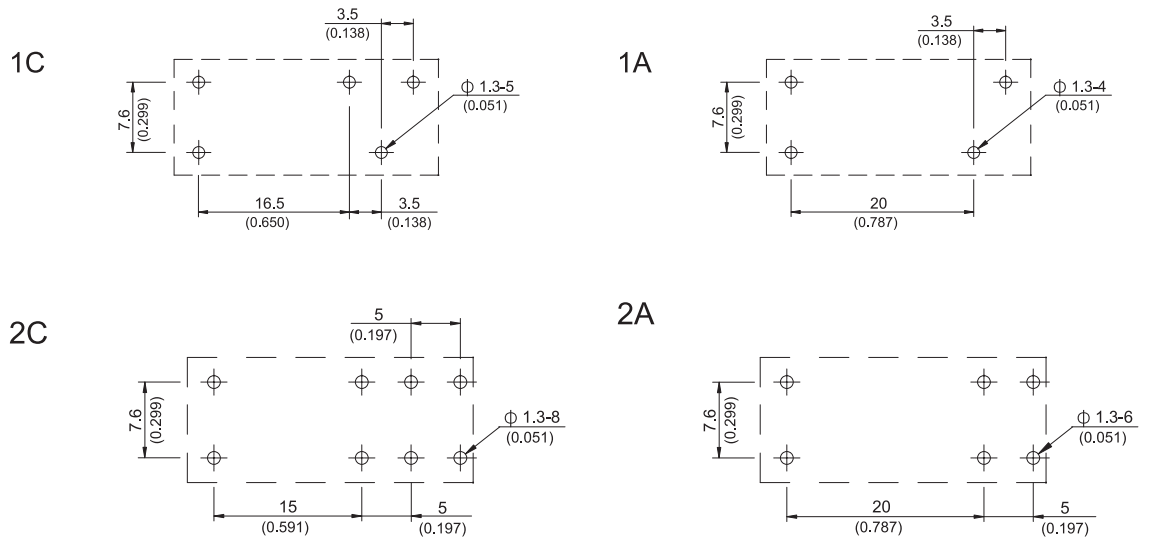

◆888H

1C

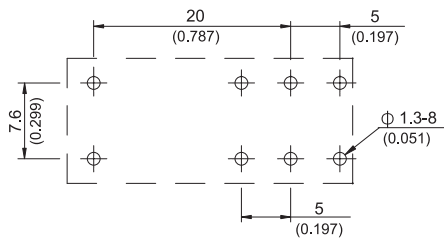

1A

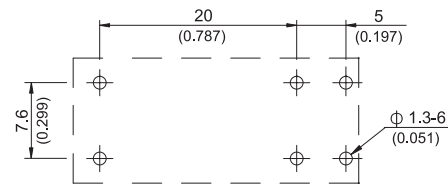

»» Engineering Data

**1 pole DC coil**

Coil operating range DC

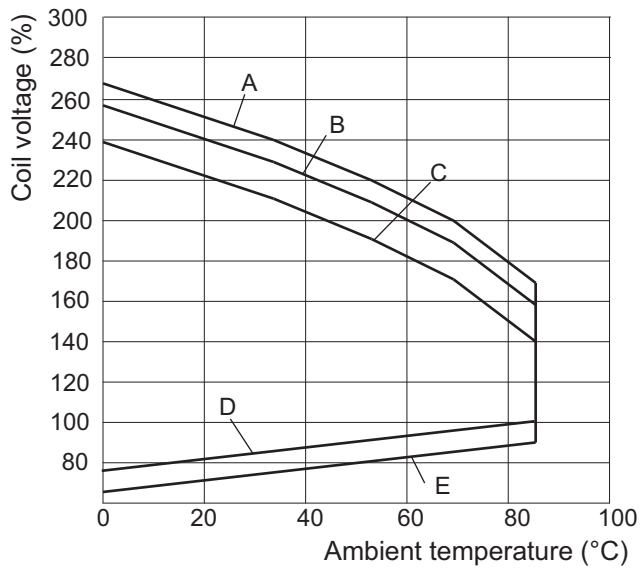

- A: contact resistive load 0A
- B: contact resistive load 8A
- C: contact resistive load 17A
- D: pick-up voltage with preenergized coil 1.1 Un and contact current 17A
- E: pick-up voltage

Life expectancy

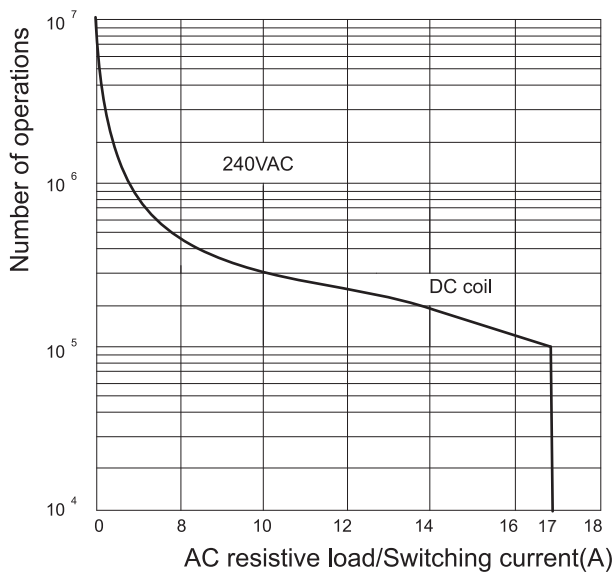

Maximum switching capacity DC load

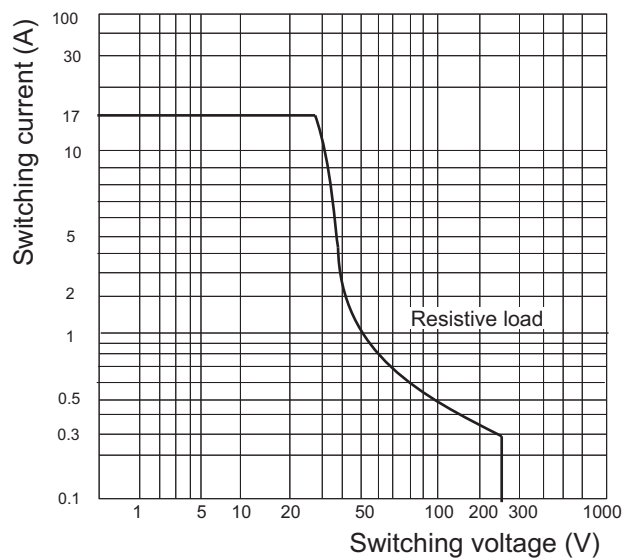



# 888

## 1 pole AC coil

Coil operating range AC

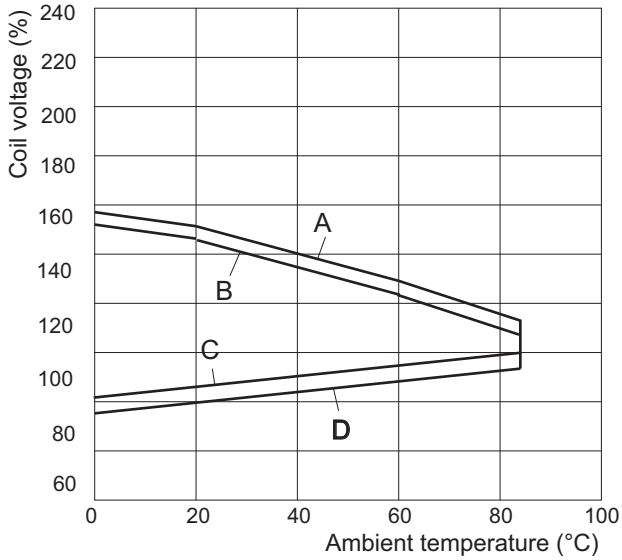

- A: contact resistive load 0A
- B: contact resistive load 17A
- C: pick-up voltage with preenergized coil 1.1 Un and contact current 17A
- D: pick-up voltage

Life expectancy

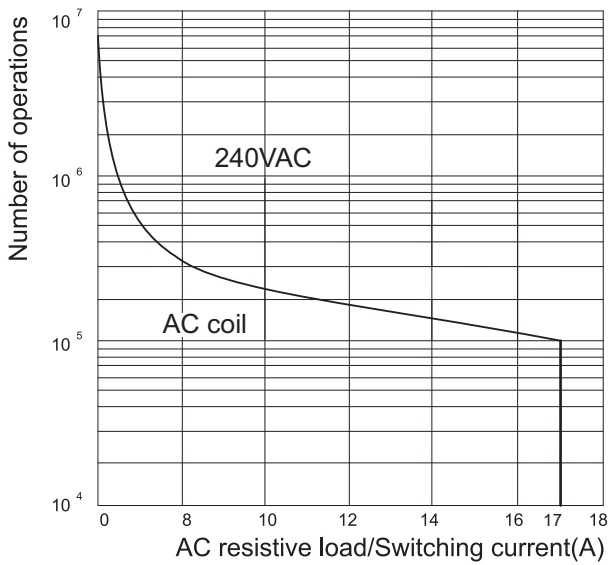

Maximum switching capacity DC load

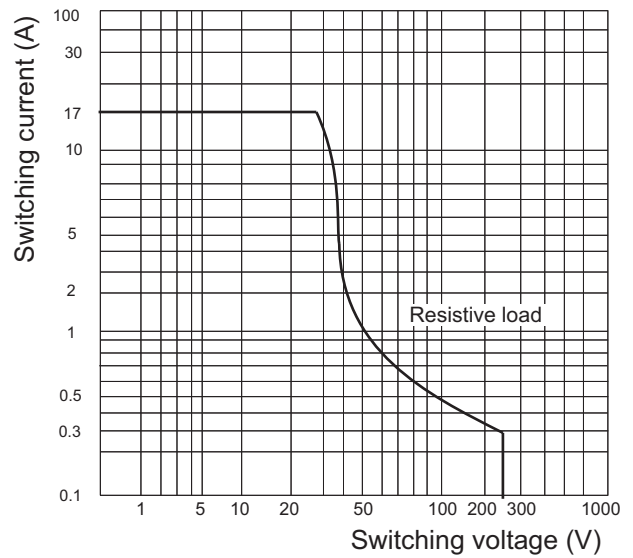



## 2 poles DC coil

Coil operating range DC

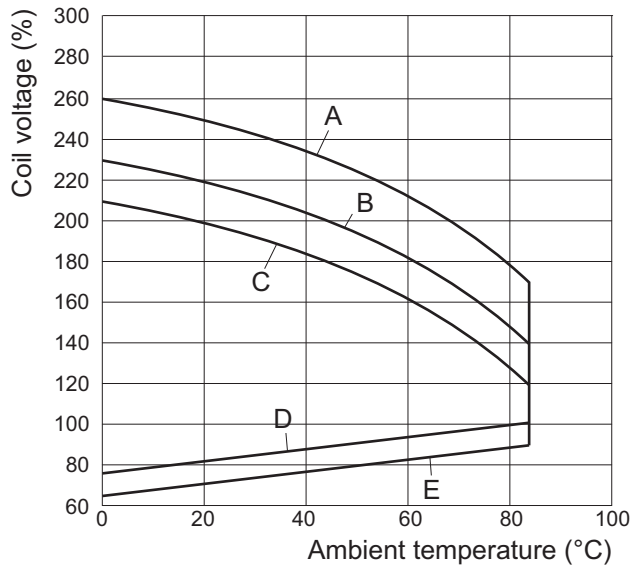

- A: contact resistive load 0A
- B: contact resistive load 2 x 8A
- C: contact resistive load 2x 12A
- D: pick-up voltage with preenergized coil 1.1 Un and contact current 2x8A
- E: pick-up voltage

Life expectancy (888 2P DC)

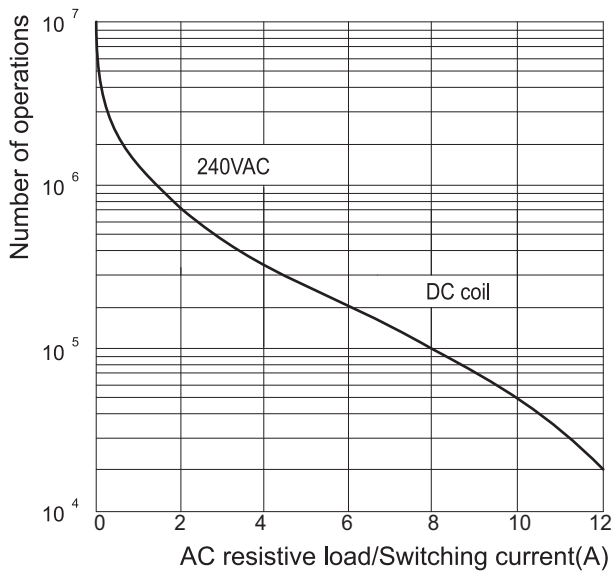

Max.DC load breaking capacity

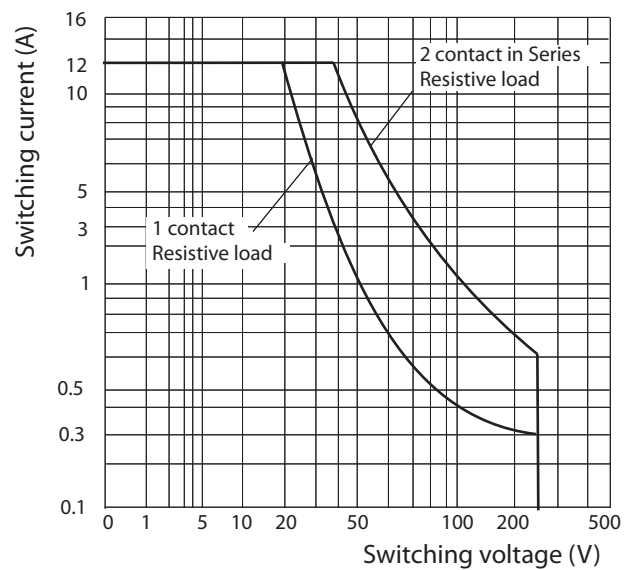



# 888

## 2 poles AC coil

Coil operating range AC

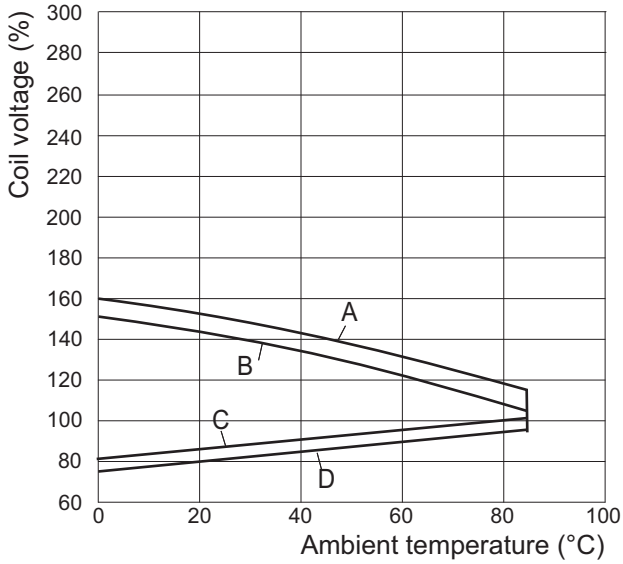

- A: contact resistive load 0A
- B: contact resistive load 2 x 10A
- C: pick-up voltage with preenergized coil 1.1 Un and contact current 2x8A
- D: pick-up voltage

Life expectancy (888 2P AC)

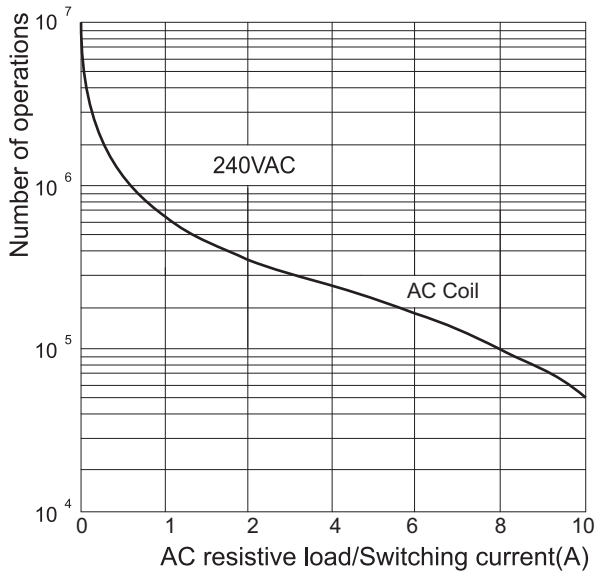

Max.DC load breaking capacity - AC coil

