



5-Phase Stepping Motor Unit

# **CFK II Series**

- Photocoupler Input
- C-MOS Input

# **OPERATING MANUAL**

## **Table of Contents**

Introduction .....	Page 2
Safety precautions .....	Page 3
Preparation .....	Page 5
Checking the product .....	Page 5
Names and functions of parts .....	Page 7
Installation .....	Page 8
Location for installation .....	Page 8
Installing the motor .....	Page 8
Installing a load .....	Page 9
Overhung load and thrust load .....	Page 10
Installing the driver .....	Page 11
Connection .....	Page 12
Connecting the motor .....	Page 12
Connecting to the power supply .....	Page 13
Connecting the I/O signals .....	Page 13
Connector preparation .....	Page 14
Connection examples .....	Page 18
Explanation of I/O signals .....	Page 20
Timing chart .....	Page 26
Setting .....	Page 28
Step angle .....	Page 28
Motor current .....	Page 29
Pulse input modes .....	Page 32
Inspection .....	Page 33
Troubleshooting and remedial actions .....	Page 34
Option .....	Page 37

Thank you for purchasing an Oriental Motor product.

This Operating Manual describes product handling procedures and safety precautions.

- Please read it thoroughly to ensure safe operation.
- Always keep the manual where it is readily available.

---

# Introduction

## Before using the motor unit

Only qualified personnel should work with the product.

Use the product correctly after thoroughly reading the section “Safety precautions.”

The product described in this manual has been designed and manufactured for use in general industrial machinery, and must not be used for any other purpose. For the driver’s power supply, use a DC power supply with reinforced insulation on its primary and secondary sides. Oriental Motor Co., Ltd. is not responsible for any damage caused through failure to observe this warning.

## Overview of the product

The **CFKII** series is a unit comprising of an open-case, high-performance micro-step driver and high-torque, low-vibration design 5-phase stepping motor. The use of micro-stepping, which gives the basic step angle of the motor greater precision, electrically provides lower vibration and lower noise with accurate angle operation without the need for a speed-reduction mechanism.

## Conformance with EC directives

Take the following measures to ensure conformance with the EC’s low voltage directive and EMC directive.

### ■ For low voltage directive

This product is not subject to the EC’s low voltage directive because its input power supply voltage is 24 to 36 VDC. However, the user is advised to perform the following step when conducting product installation and connection.

- This product is designed for use within machinery, so it should be installed within an enclosure.
- For the driver, use a DC power supply with reinforced insulation on its primary and secondary sides.

### ■ For EMC directive

The EMC measurement is not performed on the individual motor or driver. The customer is required to conduct the EMC measures on the final product incorporating the unit.

## Hazardous substances

The products do not contain the substances exceeding the restriction values of RoHS Directive (2011/65/EU).

---

# Safety precautions

The precautions described below are intended to prevent danger or injury to the user and other personnel through safe, correct use of the product. Use the product only after carefully reading and fully understanding these instructions.

## **Warning**

Handling the product without observing the instructions that accompany a “Warning” symbol may result in serious injury or death.

## **Caution**

Handling the product without observing the instructions that accompany a “Caution” symbol may result in injury or property damage.

### **Note**

The items under this heading contain important handling instructions that the user should observe to ensure safe use of the product.

## **Warning**

### **General**

- Do not use the product in explosive or corrosive environments, in the presence of flammable gases, locations subjected to splashing water, or near combustibles. Doing so may result in fire or injury.
- Assign qualified personnel the task of installing, wiring, operating/controlling, inspecting and troubleshooting the product. Failure to do so may result in fire or injury.

### **Installation**

- Install the motor and driver in their enclosures in order to prevent injury.

### **Connection**

- Keep the driver’s input-power voltage within the specified range to avoid fire.
- For the driver’s power supply, use a DC power supply with reinforced insulation on its primary and secondary sides. Failure to do so may result in electric shock.
- Connect the cables securely according to the wiring diagram in order to prevent fire.
- Do not forcibly bend, pull or pinch the power cable or motor lead wire. Doing so may result in fire.

### **Operation**

- Turn off the driver power in the event of a power failure, otherwise the motor may suddenly start when the power is restored and may cause injury or damage to equipment.

- 
- If this product is used in an elevator application, be sure to provide a measure for the position retention of moving parts. The motor loses its holding torque when the power is turned off. Failure to provide such a measure may cause the moving parts to fall off, resulting in injury or damage to the equipment.
  - Do not turn the A.W.OFF (All windings off) input to “ON” while the motor is operating. The motor will stop and lose its holding ability, which may result in injury or damage to the equipment.

### **Repair, disassembly and modification**

- Do not disassemble or modify the motor or driver. This may cause injury. Refer all such internal inspections and repairs to the branch or sales office from which you purchased the product.

### **Caution**

#### **General**

- Do not use the motor and driver beyond their specifications, or injury or damage to equipment may result.
- Do not touch the motor or driver’s heat sink during operation or immediately after stopping. The surfaces are hot and may cause a burn.

#### **Transportation**

- Do not hold the motor output shaft or motor lead wire. This may cause injury.

#### **Installation**

- Keep the area around the motor and driver free of combustible materials in order to prevent fire or a burn.
- To prevent the risk of damage to equipment, leave nothing around the motor and driver that would obstruct ventilation.
- Provide a cover over the rotating parts (output shaft) of the motor to prevent injury.

#### **Operation**

- Use the motor and driver only in the specified combination. An incorrect combination may cause a fire.
- To avoid injury, remain alert during operation so that the motor can be stopped immediately in an emergency.
- Before supplying power to the driver, turn all input signals to the driver to “OFF.” Otherwise, the motor may start suddenly and cause injury or damage to equipment.
- Before moving the motor directly with the hands (as in the case of manual positioning), confirm that the driver A.W.OFF (All windings off) input is “ON” to prevent injury.
- When an abnormality is noted, stop the operation immediately, or fire or injury may occur.

#### **Disposal**

- When disposing of the motor or driver, treat them as industrial waste.

# Preparation

This section covers the points to be checked along with the names, functions and main specifications of the respective parts.

## Checking the product

Upon opening the package, verify that the items listed below are included.

Report any missing or damaged items to the branch or sales office from which you purchased the product.

- Motor ..... 1 unit
- Driver ..... 1 unit
- Connector housing/contact ... 1 set (packed in a bag)

Input type	Photocoupler input		C-MOS input	
Driver model	DFC5103P, DFC5107P, DFC5114P	DFC5128P	DFC5107, DFC5114	DFC5128
I/O connector	1 piece 1-171822-0 10 poles (AMP)			
Motor connector	1 piece 171822-5 5 poles (AMP)	1 piece VHR-5N 5 poles (JST)	1 piece 171822-5 5 poles (AMP)	1 piece VHR-5N 5 poles (JST)
Power supply connector	1 piece 171822-3 3 poles (AMP)	1 piece VHR-2N 2 poles (JST)	1 piece 171822-3 3 poles (AMP)	1 piece VHR-2N 2 poles (JST)
I/O contact	20 pieces 170204-2 (AMP)	15 pieces 170204-2 (AMP)	20 pieces 170204-2 (AMP)	15 pieces 170204-2 (AMP)
Motor/Power supply contact		10 pieces BVH-21T-P1.1 (JST)		10 pieces BVH-21T-P1.1 (JST)

- Motor cable 600 mm ..... 1 piece (**CFK513** type only)
  - \* Only unit models come with a motor cable.
- Operating manual ..... 1 copy

Combinations of motors and drivers

■ Photocoupler input

**Standard P type**

Motor rated current	Unit model		Motor model		Driver model
	Single shaft	Double shaft	Single shaft	Double shaft	
0.35 A/phase	<b>CFK513PAP2</b>	<b>CFK513BPB2</b>	PK513PA	PK513PB	DFC5103P

**Standard type**

Motor rated current	Unit model		Motor model		Driver model
	Single shaft	Double shaft	Single shaft	Double shaft	
0.35 A/phase	<b>CFK523AP2</b>	<b>CFK523BP2</b>	PK523A	PK523B	DFC5103P
	<b>CFK525AP2</b>	<b>CFK525BP2</b>	PK525A	PK525B	
0.75 A/phase	<b>CFK543AP2</b>	<b>CFK543BP2</b>	PK543NAW	PK543NBW	DFC5107P
	<b>CFK544AP2</b>	<b>CFK544BP2</b>	PK544NAW	PK544NBW	
1.4 A/phase	<b>CFK545AP2</b>	<b>CFK545BP2</b>	PK545NAW	PK545NBW	DFC5114P
	<b>CFK564AP2</b>	<b>CFK564BP2</b>	PK564NAW	PK564NBW	
	<b>CFK566AP2</b>	<b>CFK566BP2</b>	PK566NAW	PK566NBW	
	<b>CFK569AP2</b>	<b>CFK569BP2</b>	PK569NAW	PK569NBW	

**High-speed type**

Motor rated current	Unit model		Motor model		Driver model
	Single shaft	Double shaft	Single shaft	Double shaft	
2.8 A/phase	<b>CFK566HAP2</b>	<b>CFK566HBP2</b>	PK566HNAW	PK566HNBW	DFC5128P
	<b>CFK569HAP2</b>	<b>CFK569HBP2</b>	PK569HNAW	PK569HNBW	
	<b>CFK596HAP2</b>	<b>CFK596HBP2</b>	PK596HNAW	PK596HNBW	
	<b>CFK599HAP2</b>	<b>CFK599HBP2</b>	PK599HNAW	PK599HNBW	
	<b>CFK5913HAP2</b>	<b>CFK5913HBP2</b>	PK5913HNAW	PK5913HNBW	

■ C-MOS input

**Standard type**

Motor rated current	Unit model		Motor model		Driver model
	Single shaft	Double shaft	Single shaft	Double shaft	
0.75 A/phase	<b>CFK543A2</b>	<b>CFK543B2</b>	PK543NAW	PK543NBW	DFC5107
	<b>CFK544A2</b>	<b>CFK544B2</b>	PK544NAW	PK544NBW	
	<b>CFK545A2</b>	<b>CFK545B2</b>	PK545NAW	PK545NBW	
1.4 A/phase	<b>CFK564A2</b>	<b>CFK564B2</b>	PK564NAW	PK564NBW	DFC5114
	<b>CFK566A2</b>	<b>CFK566B2</b>	PK566NAW	PK566NBW	
	<b>CFK569A2</b>	<b>CFK569B2</b>	PK569NAW	PK569NBW	

**High-speed type**

Motor rated current	Unit model		Motor model		Driver model
	Single shaft	Double shaft	Single shaft	Double shaft	
2.8 A/phase	<b>CFK566HA2</b>	<b>CFK566HB2</b>	PK566HNAW	PK566HNBW	DFC5128
	<b>CFK569HA2</b>	<b>CFK569HB2</b>	PK569HNAW	PK569HNBW	
	<b>CFK596HA2</b>	<b>CFK596HB2</b>	PK596HNAW	PK596HNBW	
	<b>CFK599HA2</b>	<b>CFK599HB2</b>	PK599HNAW	PK599HNBW	
	<b>CFK5913HA2</b>	<b>CFK5913HB2</b>	PK5913HNAW	PK5913HNBW	

## Names and functions of parts

This section covers the names and functions of parts in the driver and motor.

### Driver

Illustration shows the DFC5128P.

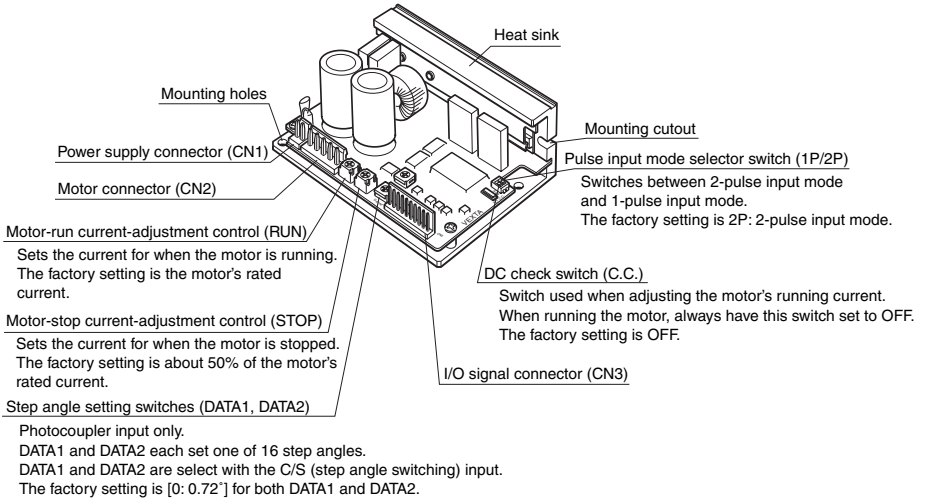

### Motor

Illustration typical for the PK56□ and PK59□.

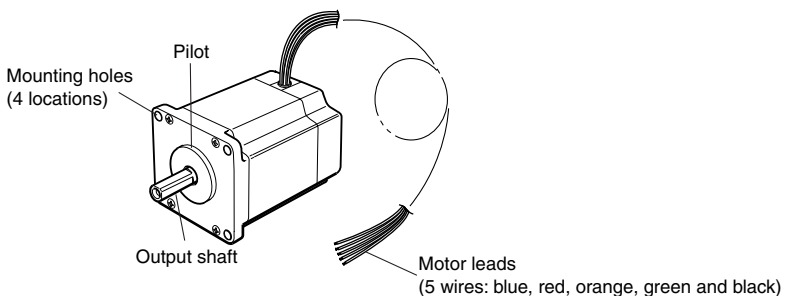

### Note

- Even when the motor is stopped, the current remains on and the motor continues to generate heat.
- While the motor is in the stopped state, the current is automatically reduced to a value preset by the motor-stop current-adjustment control (STOP) to limit the generation of heat. The motor's holding torque is also reduced in proportion to the stopped-state current. Adjust the motor-stop current-adjustment control (STOP) setting to ensure the necessary load-holding torque.





• Bolt size and tightening torque

Motor model		Bolt size	Tightening torque	Effective depth of bolt	Type of installation
PK513PA	PK513PB	M2	0.25 N·m (2.5 kgfcm)	2.5 mm	A
PK523A	PK523B	M2.5	0.5 N·m (5 kgfcm)	2.5 mm	A
PK525A	PK525B				
PK543NAW	PK543NBW	M3	1 N·m (10 kgfcm)	4.5 mm	A
PK544NAW	PK544NBW				
PK545NAW	PK545NBW				
PK564NAW	PK564NBW	M4	2 N·m (20 kgfcm)	–	B
PK566NAW	PK566NBW				
PK566HNAW	PK566HNBW				
PK569NAW	PK569NBW				
PK569HNAW	PK569HNBW				
PK596HNAW	PK596HNBW	M5	3 N·m (30 kgfcm)	–	B
PK599HNAW	PK599HNBW				
PK5913HNAW	PK5913HNBW				

**Note**

Insert the pilot located on the motor's installation surface into the mounting plate's countersunk or through hole.

## Installing a load

When connecting a load to the motor, align the centers of the motor's output shaft and load shaft.

### ■ Direct coupling

Align the centers of the motor's output shaft and load shaft in a straight line.

### ■ Using a belt drive

Align the motor's output shaft and load shaft in parallel with each other, and position both pulleys so that the line connecting their centers is at a right angle to the shafts.

### ■ Using a gear drive

Align the motor's output shaft and gear shaft in parallel with each other, and let the gears mesh at the center of the tooth widths.

**Note**

- When coupling the load to the motor, pay attention to the centering of the shafts, belt tension, parallelism of the pulleys, and so on.  
Securely tighten the coupling and pulley set screws.
- Be careful not to damage the output shaft or bearings when installing a coupling or pulley to the motor's output shaft.
- Do not modify or machine the motor's output shaft.  
Doing so may damage the bearings and destroy the motor.

## Overhung load and thrust load

The overhung load on the motor's output shaft must be kept under the permissible values listed below.

The thrust load must not exceed the motor's mass.

Motor model		Distance from the tip of motor's output shaft				
		0 mm	5 mm	10 mm	15 mm	20 mm
PK513PA	PK513PB	12 N (1.2 kgf)	15 N (1.5 kgf)	–	–	–
PK523A	PK523B	25 N (2.5 kgf)	34 N (3.4 kgf)	52 N	–	–
PK525A	PK525B			(5.2 kgf)	–	–
PK543NAW	PK543NBW	20 N (2 kgf)	25 N (2.5 kgf)	34 N	52 N	–
PK544NAW	PK544NBW			(3.4 kgf)	(5.2 kgf)	
PK545NAW	PK545NBW					
PK564NAW	PK564NBW	63 N (6.3 kgf)	75 N (7.5 kgf)	95 N	130 N	190 N
PK566NAW	PK566NBW			(9.5 kgf)	(13 kgf)	(19 kgf)
PK569NAW	PK569NBW					
PK566HNAW	PK566HNBW					
PK569HNAW	PK569HNBW					
PK596HNAW	PK596HNBW	260 N (26 kgf)	290 N (29 kgf)	340 N	390 N	480 N
PK599HNAW	PK599HNBW			(34 kgf)	(39 kgf)	(48 kgf)
PK5913HNAW	PK5913HNBW					

### Note

Failure due to fatigue may occur when the motor bearings and output shaft are subject to repeated loading by an overhung or thrust load that is in excess of the permissible limit.

## Installing the driver

### ■ Installation method

Install the driver on a flat metal plate having superior capacity to withstand vibration as well as a high heat conductance effect. Always install the driver using the driver's installation holes and install and fasten it either vertically or horizontally with the two screws (M3; not supplied with unit) so that there is no gap between the driver and the metal plate.

Any other installation method will reduce the heat-radiating effect for the driver.

Illustrations show the DFC5128P.

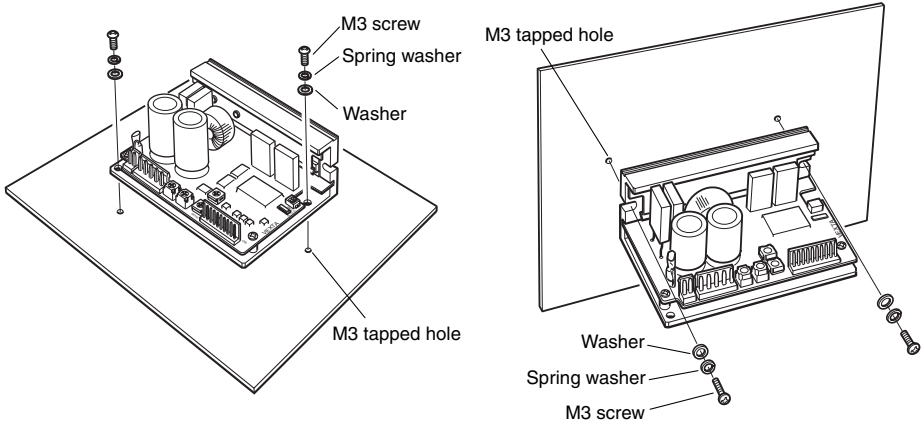

There must be a clearance of at least 25 mm and 50 mm in the horizontal and vertical directions, between the driver and enclosure or other equipment.

When two or more drivers are to be installed side by side, provide 20 mm clearances in the horizontal.

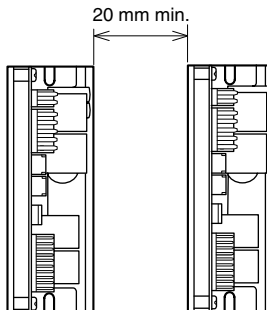

### Note

- Do not install any equipment that generates a large amount of heat near the driver.
- Check ventilation if the ambient temperature of the driver exceeds 40°C.

---

# Connection

This section covers the methods of connecting the driver, motor, power and controller, as well as connection examples and I/O interface.

Crimp the leads and cables into the respective contacts and assemble the contacts into the connectors. See “Connector preparation” on page 14.

Optional motor cables and driver cables (sold separately) are available from Oriental Motor. See page 37 for details.

## Connecting the motor

Connect the motor connector into the driver’s motor connector (CN2).

The **CFK513** model has a connector with motor leads. Use the supplied motor cable with connector.

Illustration shows the DFC5128P.  
Illustration typical for the lead wire type.

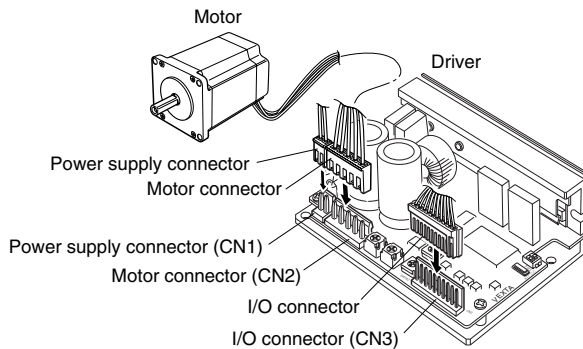

### Note

- Firmly insert the connector in position.  
Incomplete connection of the connector may cause operation failure, or may damage the motor or driver.
- If the noise generated from the motor leads becomes a problem, shield the motor leads with electrically conductive tape, wire mesh or the like.

---

## Connecting to the power supply

The input power supply voltage is 24 to 36 VDC±10%. Use a power supply capable of supplying the power/current capacity as shown below.

Driver model	DFC5103P	DFC5107P DFC5107	DFC5114P DFC5114	DFC5128P DFC5128
Motor drive	0.6 A min.	1 A min.	2 A min.	4 A min.
Logic circuit	5 VDC±5% 0.1 A min. (C-MOS input only)			

Connecting the power supply connector into the driver's power supply connector (CN1).

### Note

- For the power supply cable, use a cable with a diameter equivalent to AWG22 to 20 (0.3 to 0.5 mm<sup>2</sup>) for the standard P type (DFC5103P) and standard type (DFC5103P, DFC5107P, DFC5107, DFC5114P, DFC5114), and AWG20 to 18 (0.5 to 0.75 mm<sup>2</sup>) for the high-speed type (DFC5128P, DFC5128). Be sure to connect the power supply using the correct polarity. If the power supply's polarity is reversed, the driver may be damaged.
- Firmly insert the connector in position.  
Incomplete connection of the connector may cause operation failure, or may damage the motor or driver.
- Do not route the power supply cables in the same conduits as other power supply lines and motor leads.
- Always wait at least 5 sec. after switching off the power before switching it back on again or connecting/disconnecting the motor lead wire connector.

## Connecting the I/O signals

Connect the I/O connector into the driver's I/O signal connector (CN3).

### Note

- For the I/O signal cable, use twisted pair with a diameter equivalent to at least AWG24 to 22 (0.2 to 0.34 mm<sup>2</sup>). To suppress the effect of noise, make the cable as short as possible (2 m max.).
- Separate I/O signal cables at least 300 mm from electromagnetic relays and other inductive loads. Additionally, route I/O signal cables perpendicular to power supply cables and motor leads, rather than in a parallel fashion.

## Connector preparation

### ■ Driver connector

1. Crimp the motor leads, power supply cable and I/O cable into the connector contacts.  
When crimp-fitting the contact, secure a strong connection using a crimping tool as specified by the contact manufacturer. Oriental Motor does not provide crimping tools.

Driver model		DFC5103P, DFC5107P DFC5114P, DFC5107 DFC5114	DFC5128P, DFC5128
Power supply	Connector housing	AMP 171822-3	JST VHR-2N
	Contact	AMP 170204-2	JST BVH-21T-P1.1
	Crimping tool	AMP 189509-1	JST YC-160R
Motor	Connector housing	AMP 171822-5	JST VHR-5N
	Contact	AMP 170204-2	JST BVH-21T-P1.1
	Crimping tool	AMP 189509-1	JST YC-160R
I/O	Connector housing	AMP 1-171822-0	AMP 1-171822-0
	Contact	AMP 170204-2	AMP 170204-2
	Crimping tool	AMP 189509-1	AMP 189509-1

2. Insert the contacts crimped with the leads or cables into the respective connectors according to the connector pin assignments shown on pages 15 and 16.

## Connector pin assignments

### ■ Photocoupler input

	Connector	Pin No.	I/O	Signal name	Explanation
Power supply connector	CN1	1	Input	POWER	24-36 VDC±10%
		2			GND
		3			NC (DFC5103P, DFC5107P, DFC5114P only)
Motor connector	CN2	1	Output	MOTOR	Blue motor lead
		2			Red motor lead
		3			Orange motor lead
		4			Green motor lead
		5			Black motor lead
I/O connector	CN3	1	Input	CW+ (PLS+)	CW pulse (Pulse) input * photocoupler anode side
		2		CW- (PLS-)	CW pulse (Pulse) input * photocoupler cathode side
		3		CCW+ (DIR+)	CCW pulse (Rotational direction) input * photocoupler anode side
		4		CCW- (DIR-)	CCW pulse (Rotational direction) input * photocoupler cathode side
		5		A.W.OFF+	All windings off input anode side
		6		A.W.OFF-	All windings off input cathode side
		7	Output	TIMING+	Excitation timing output collector side
		8		TIMING-	Excitation timing output emitter side
		9	Input	C/S+	Step angle switching input anode side
		10		C/S-	Step angle switching input cathode side

\* When the pulse input selector switch is set to 2-pulse input mode, the inputs are CW and CCW.

When the pulse input selector switch is set to 1-pulse input mode, the inputs are the pulse input and the rotation-direction input.

## ■C-MOS input

	Connector	Pin No.	I/O	Signal name	Explanation
Power supply connector	CN1	1	Input	POWER	24-36 VDC±10%
		2			GND
		3			NC (DFC5107, DFC5114 only)
Motor connector	CN2	1	Output	MOTOR	Blue motor lead
		2			Red motor lead
		3			Orange motor lead
		4			Green motor lead
		5			Black motor lead
I/O connector	CN3	1	Input	GND	Logic power supply input GND
		2		+5 V	Logic power supply input +5 VDC±10%
		3		D <sub>0</sub>	Step angle setting input
		4		D <sub>1</sub>	
		5		D <sub>2</sub>	
		6		D <sub>3</sub>	
		7		CW (PLS)	CW pulse (PLS) input *
		8		CCW (DIR)	CCW pulse (DIR) input *
		9		A.W.OFF	All windings off input
		10		Output	TIMING

\* When the pulse input selector switch is set to 2-pulse input mode, the inputs are CW and CCW.

When the pulse input selector switch is set to 1-pulse input mode, the inputs are the pulse input and the rotation-direction input.



## ■ Motor connector (CFK513 type only)

The **CFK513** type motors are of the connector type having no leads.

To connect these motors, use the supplied motor cable.

The applicable connector housing/contact, crimping tool and connector configuration are shown below.

### Connector housing/contact, crimping tool

Connector housing	MOLEX 51065-0500
Contact	MOLEX 50212-8xxx
Crimping tool	MOLEX 57176-5000

### Connector configuration

Terminal No.	1	2	3	4	5
Motor lead color	Blue	Red	Orange	Green	Black

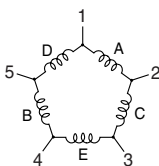
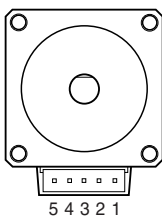

### Note

When connecting to the **CFK513** type motor, arrange the cable at the connector such that the connected part will not be overly stressed as a result of bending of the cable. Set the cable's radius of curvature as large as possible.

## Connection examples

Examples of connections with the motor, power supply and controller are shown below.

### ■ Photocoupler input

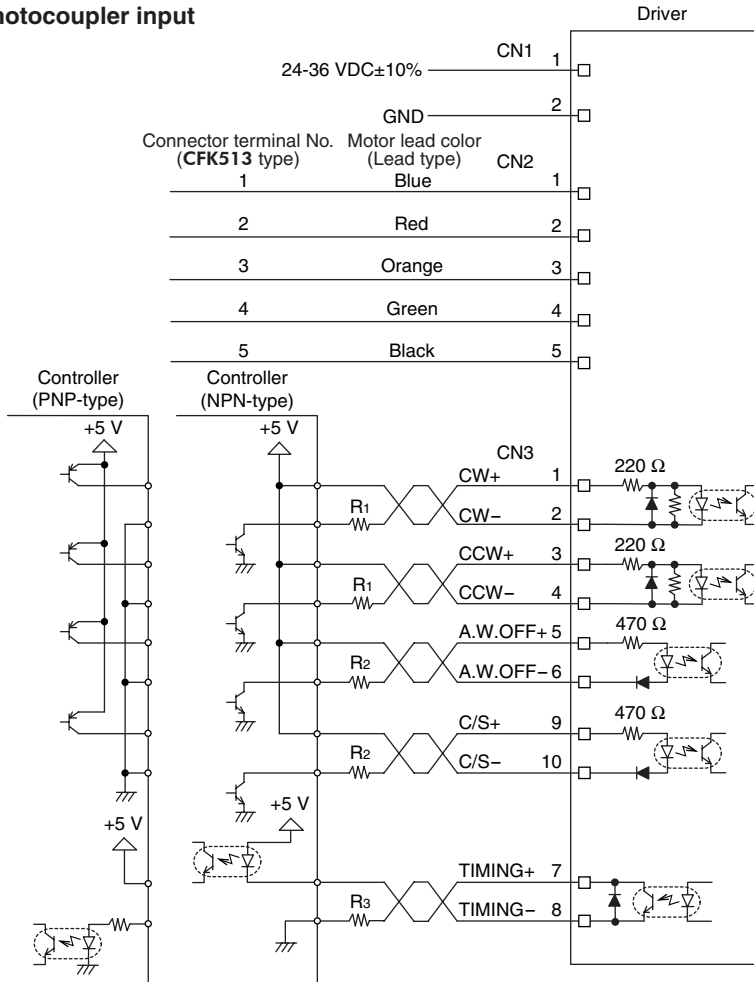

#### Note

- Make the input signal voltage 5 VDC minimum and 24 VDC maximum.  
When the input signal voltage is 5 VDC, external resistors R1 and R2 in the diagram are not necessary. If the input signal voltage is greater than 5 VDC, connect external resistors R1 and R2, as shown in the diagram, to restrict the input current as follows:  
CW, CCW: 20 mA max.  
A.W.OFF, C/S: 15 mA max.
- Use an output signal voltage of 5 VDC minimum and 24 VDC maximum, and use output signal current of 10 mA max.  
If the output signal current is greater than 10 mA, connect external resistor R3, as shown in the diagram, to restrict the current to no more than 10 mA.
- Be certain the digital I/O cables that connect the driver and controller is as short as possible.  
The maximum input frequency will decrease as the cable length increases.

## ■ C-MOS input

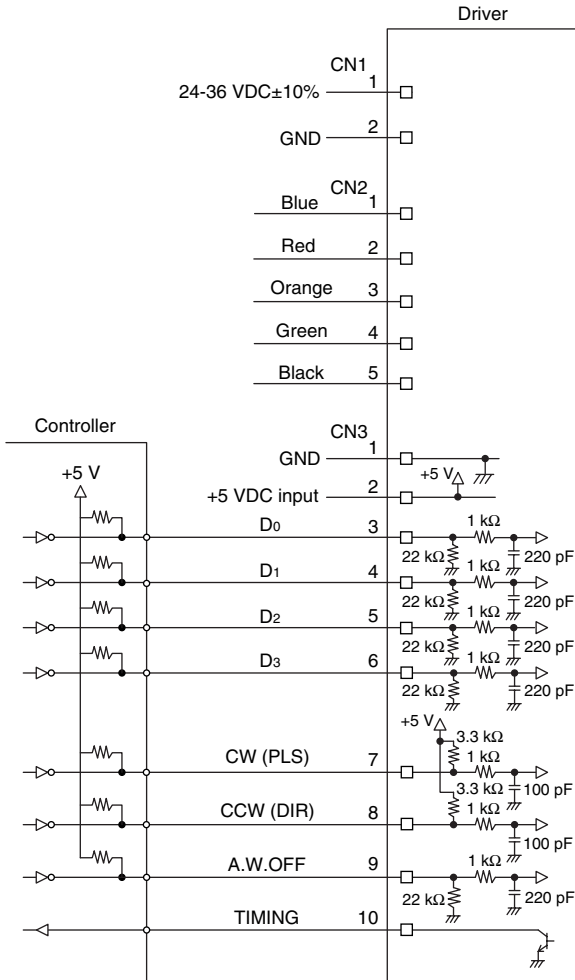

### Note

- Use an output signal voltage of 3 VDC minimum and 30 VDC maximum, and use output signal current of 15 mA max.
- Be certain the digital I/O cables that connect the driver and controller is as short as possible. The maximum input frequency will decrease as the cable length increases.

## Explanation of I/O signals

### ■ Input signals

- The signal states indicate the state of the internal photocoupler (ON: power conducted; OFF: power not conducted).
- The signal state of C-MOS input is specified by a voltage level.  
“H: +4 to 5 V”, “L: 0 to +0.6 V”

### ◆ CW input and CCW input

This driver can select either 1-pulse input mode or 2-pulse input mode as the pulse input mode to match the controller used. For details on how to set the pulse input mode, see page 32, “Pulse input modes.”

### Photocoupler input (for C-MOS input, see page 22.)

#### 2-pulse input mode (factory setting)

The controller's CW pulses are connected to the CW+ (pin No.1) or the CW- (pin No.2), while the CCW pulses are connected to the CCW+ (pin No.3) or the CCW- (pin No.4).

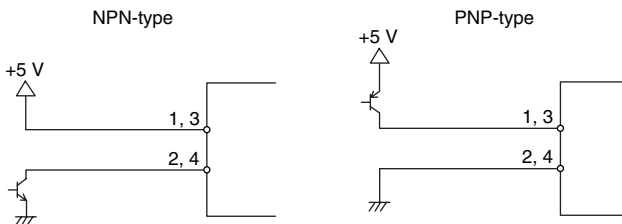

1. When the CW pulse input changes from the “ON” state to “OFF” state, the motor will rotate one step in the CW direction.
2. When the CCW pulse input changes from the “ON” state to “OFF” state, the motor will rotate one step in the CCW direction.

For the pulse signals use input pulses with sharp rising and trailing edges, as shown in the figure.

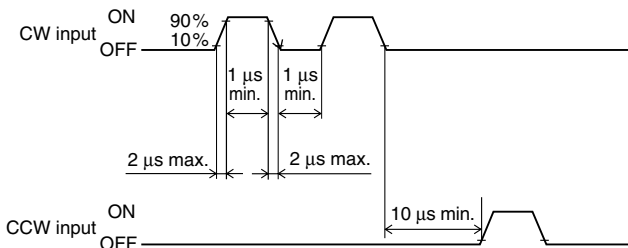

## Note

- Do not allow the driver's temperature to exceed 70°C, which is the heat-radiating plate's saturation temperature during operation.
- The minimum value for the interval time when switching the rotational direction depends on the motor's size, running speed and load moment of inertia.
- Always set the photocoupler to "OFF" when not inputting pulse signals. Otherwise, the driver can't shift to the motor standstill current.
- Do not input CW input and CCW input at the same time.  
If one of these pulses is input when the other is "ON" the motor will not run properly.

## 1-pulse input mode

The controller pulses are connected to the PLS+ input (pin No.1) or the PLS- input (pin No.2), and the rotation direction is connected to the DIR+ input (pin No.3) or DIR- input (pin No.4).

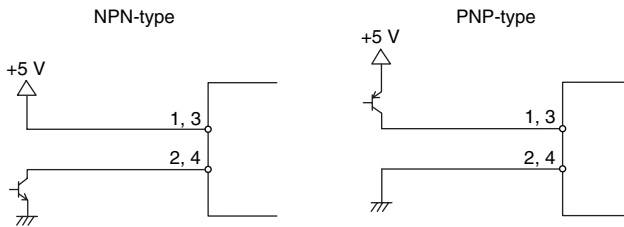

1. When the DIR input is "ON," a fall of the "PLS input" from "ON" to "OFF" will rotate the motor one step in the CW direction.
2. When the DIR input is "OFF," a fall of the "PLS input" from "ON" to "OFF" will rotate the motor one step in the CCW direction.

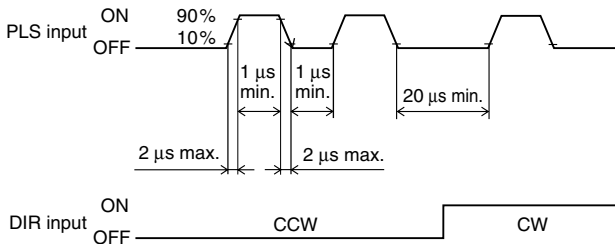

## Note

- Do not allow the driver temperature to exceed 70°C, which is the heat radiating plate's saturation temperature during operation.
- The minimum value for the interval time when switching the rotational direction depends on the motor's size, running speed and load moment of inertia.

---

## C-MOS input

### 2-pulse input mode (factory setting)

The controller's CW pulses are connected to the CW+ (pin No.7), while the CCW pulses are connected to the CCW+ (pin No.8).

### 1-pulse input mode

The controller pulses are connected to the PLS input (pin No.7), and the rotation direction is connected to the DIR input (pin No.8).

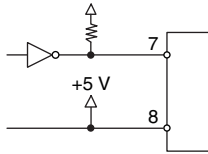

For the pulse signals use input pulses with sharp rising and trailing edges, as shown in the figure below.

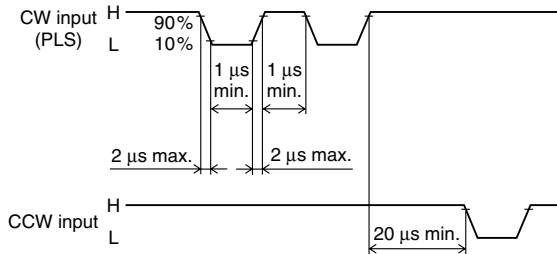

- The motor rotates by one step at the rise of a pulse.
- Pulse voltage H: +4 to 5 V, L: 0 to +0.6 V
- Pulse width 1 μsec or more
- Pulse rise/pulse fall time 2 μsec or less
- Pulse duty 50% or less

### Note

- Do not allow the driver's temperature to exceed 70°C, which is the heat-radiating plate's saturation temperature during operation.
- The minimum value for the interval time when switching the rotational direction depends on the motor's size, running speed and load moment of inertia.
- Be sure to set the pulse signal level to H level when the motor is stopped. If the pulse signal level remains at the L level, the current will not drop to the specified motor-stop setting current

---

### ◆A.W.OFF (All windings off) input

This is used to rotate the motor's output shaft and adjust its position.

---

**⚠ Warning** • Do not turn the A.W.OFF (All windings off) input to "ON" while the motor is operating. The motor will stop and lose its holding ability, which may result in injury or damage to the equipment.

---

**⚠ Caution** • Before moving the motor directly with the hands (as in the case of manual positioning), confirm that the driver A.W.OFF (All windings off) input is "ON" to prevent injury.

---

1. When the A.W.OFF input is turned to "ON," (C-MOS input: H level) the driver cuts off the current supply to the motor and the motor loses its holding brake force. In this condition the position of the output shaft can be adjusted manually.
2. When the A.W.OFF input is turned to "OFF," (C-MOS input: L level) the driver resumes the current supply to the motor and restores the motor's holding torque. The A.W.OFF input must be "OFF" when operating the motor.

### Note

When the A.W.OFF input is not used, keep the A.W.OFF input in the "OFF" (C-MOS input: L level) or leave it disconnected.

### ◆C/S (step angle switching) input (photocoupler input only)

This signal selects the step angle set with one of the two step angle setting switches (DATA1 and DATA2).

For example, when DATA1 is set to [0: 0.72°] and DATA2 is set to [6: 0.072°], this signal can switch between 0.72°-step operation and 0.072°-step operation. For details on setting the step angle setting switch, see page 28, "Step angle."

1. When the C/S input is turned to "ON," operation switches to the setting for step angle setting switch DATA2.
2. When the C/S input is turned to "OFF," operation switches to the setting for step angle setting switch DATA1.

**◆C/S (step angle setting) input C-MOS input only**

This input is used to set the motor step angle.

A total of 16 step angles can be set by combining the four signals of D0 to D3.

D3	D2	D1	D0	Step angle (Division number)	D3	D2	D1	D0	Step angle (Division number)
L	L	L	L	0.72° (1)	H	L	L	L	0.0288° (25)
L	L	L	H	0.36° (2)	H	L	L	H	0.018° (40)
L	L	H	L	0.288° (2.5)	H	L	H	L	0.0144° (50)
L	L	H	H	0.18° (4)	H	L	H	H	0.009° (80)
L	H	L	L	0.144° (5)	H	H	L	L	0.0072° (100)
L	H	L	H	0.09° (8)	H	H	L	H	0.00576° (125)
L	H	H	L	0.072° (10)	H	H	H	L	0.0036° (200)
L	H	H	H	0.036° (20)	H	H	H	H	0.00288° (250)

**Note**

Change the step angle while the motor is stopped. If a new step angle is set while the motor is operating, the motor will not stop precisely at the desired position.

**Example** Switching the step angle from 0.072° to 0.72°

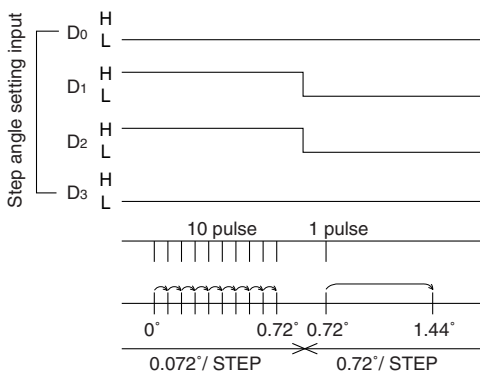



---

## ■ Output signals

The driver's output signals are photocoupler/open-collector outputs. The signal states indicate the state of the internal photocoupler (ON: power conducted; OFF: power not conducted).

### ◆ Timing (excitation timing) output

When the motor excitation state (combined phases of current flowing) is in the excitation home position (step [0]), the driver switches on the timing output. The motor excitation state is reset to the excitation home position when the power supply is switched on.

The timing output comes on every  $7.2^\circ$  of motor rotation, being synchronized with the pulse input. When the pulse signals are input at an integer multiple of the number of pulses required for the motor to rotate  $7.2^\circ$ , then it is possible to check whether or not the driver is operating normally by monitoring the timing output.

Also, when detecting the mechanical home position for a mechanical device, by making an AND circuit for the mechanical home position sensor and the timing output, the variation in the motor stop position within the mechanical home position sensor can be reduced and the mechanical home position made more precise.

### Note

- When using the timing output, stop the motor's output shaft at an integer multiple of  $7.2^\circ$ .
- When switching the step angle using the C/S (step angle switch) input (photocoupler input only) or step angle setting input (C-MOS input only), do this with the motor stopped and the timing output on. If the C/S input or step angle setting input is switched in any other condition, the timing output may not turn "ON" even after the motor has rotated  $0.72^\circ$ .

# Timing chart

## ■ Photocoupler input

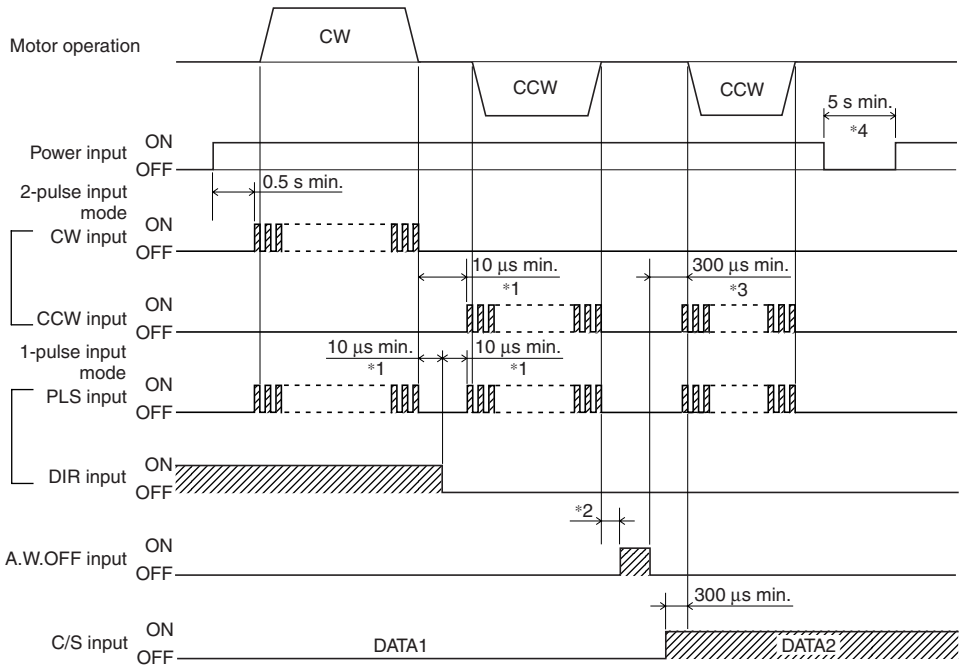

The  section indicates that the photocoupler diode is emitting light.

- \*1 Switching time to change CW,CCW pulse (2-pulse input mode), and switching time to change direction (1-pulse input mode) 10 μs is shown as a response time of circuit. The motor may need more time.
- \*2 Depends on load inertia, load torque, and starting frequency.
- \*3 Do not input pulse signals immediately after switching the A.W.OFF input to "OFF", given that it will affect the motor's starting characteristics. This period should normally be set to approximately 0.1 second.
- \*4 Wait at least 5 seconds before turning on the power.

### Note

- Do not switch the A.W.OFF input to "ON" while the motor is running.
- Always set the photocoupler to "OFF" when pulse signals are not being input.
- Do not input a CW pulse and CCW pulse simultaneously. If a pulse is input while the other photocoupler is in the "ON" state, the motor will not operate properly.

## ■ C-MOS input

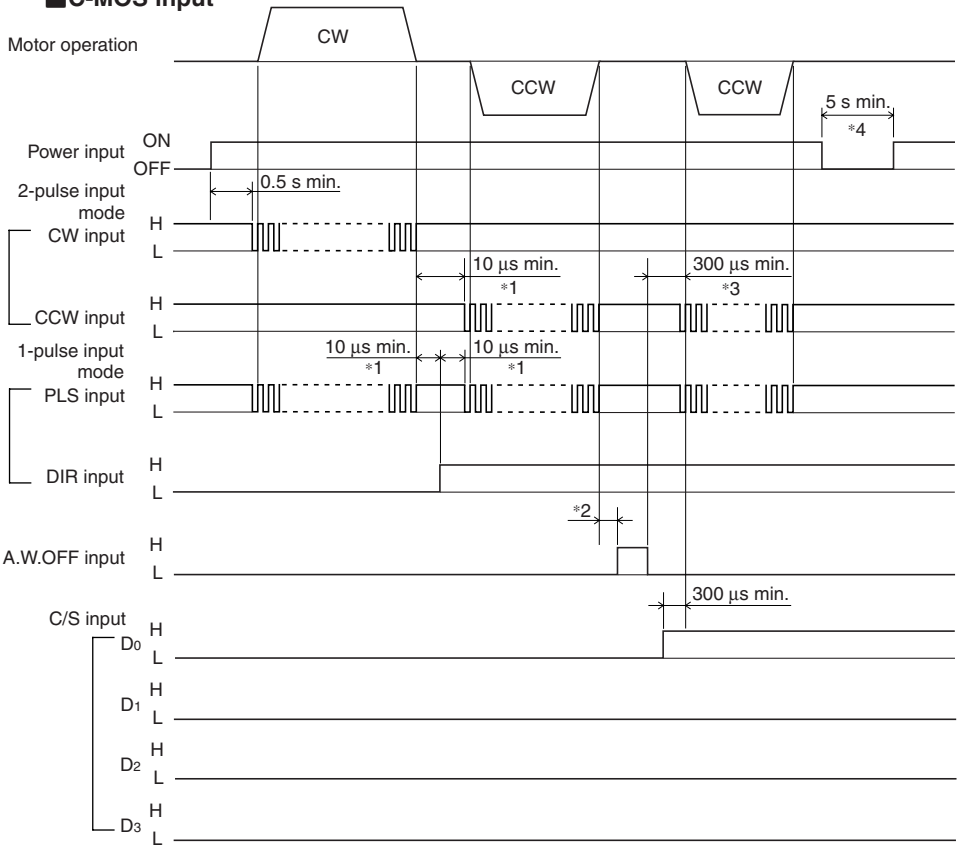

\*1 Switching time to change CW,CCW pulse (2-pulse input mode), and switching time to change direction (1-pulse input mode) 10  $\mu$ s is shown as a response time of circuit. The motor may need more time.

\*2 Depends on load inertia, load torque, and starting frequency.

\*3 Do not input pulse signals immediately after switching the A.W.OFF input to "L level", given that it will affect the motor's starting characteristics. This period should normally be set to approximately 0.1 second.

\*4 Wait at least 5 seconds before turning on the power.

### Note

- Be sure to set the signal level to "H level" when pulse signals are not input.
- Do not input the CW input and CCW input simultaneously.

If either CW or CCW pulse is input when the signal level of the other input is "L level," the motor will not operate properly.

# Setting

This section describes the methods for setting the step angle and motor's current setting and switching the pulse input mode.

## Step angle

(For C-MOS input, see page 24.)

When setting the motor's step angle, use the step angle setting switches (DATA1 and DATA2).

Factory settings DATA1 [0: 0.72°], DATA2 [0: 0.72°]

- There are 16 settings, ranging from [0] to [F]. The step angle for each setting is given in the table below.
- When changing a step angle setting, use a precision screwdriver to switch the DATA1 or DATA2 scale.
- The step angle set by DATA1 or by DATA2 is selected with the C/S (step angle switching) input. For details on C/S (step angle switching) input, see page 23.

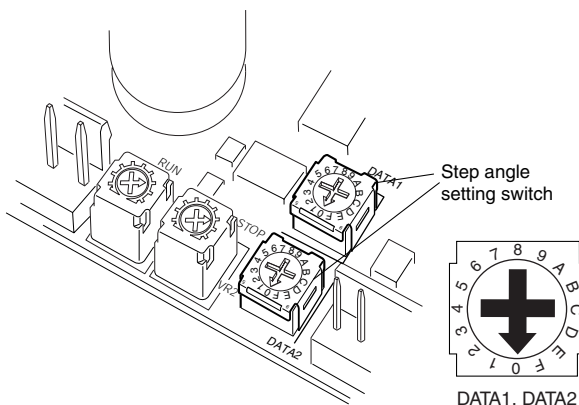

Dial setting	Step angle
0	0.72°
1	0.36°
2	0.288°
3	0.18°
4	0.144°
5	0.09°
6	0.072°
7	0.036°
8	0.0288°
9	0.018°
A	0.0144°
B	0.009°
C	0.0072°
D	0.00576°
E	0.0036°
F	0.00288°



## ■ Adjusting the motor's run current

1. Turn the DC check switch to the "ON."
2. Switch on the driver's power supply.
3. Turning the motor's run-current adjustment in the counterclockwise direction reduces the current. One-half the value displayed on the ammeter is the current per phase of the motor.  
(Example: 5.6 A = 2.8 A/phase)

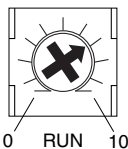
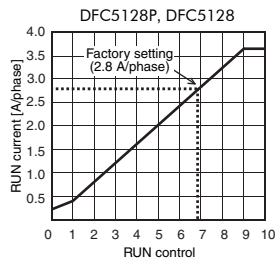
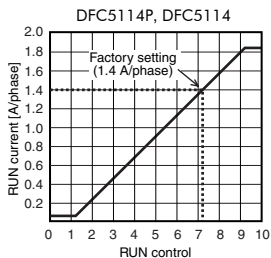
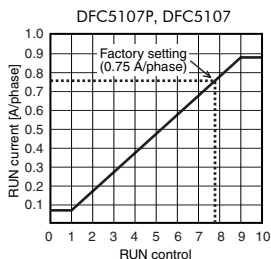
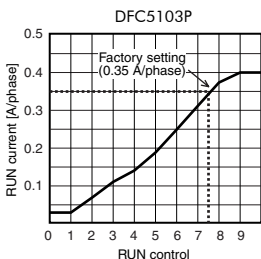
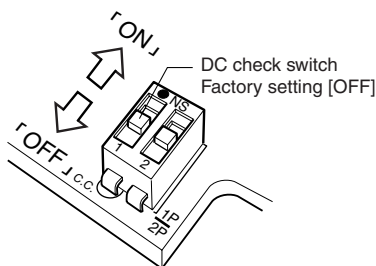

The scale values are not displayed on the control.

4. After adjusting the run control, return the current check switch to the "OFF."

### Note

- After adjusting the run current, always return the current check switch to the "OFF." If this switch is set to "ON," when the motor stops the motor current does not decrease to the motor-stop current level.
- Always adjust the run current to no more than value of rated current. Higher current can damage the motor and driver.

## ■ Adjusting the motor's stop current

1. Turn the DC check switch to the "OFF."
2. Switch on the driver's power supply.
3. Turning the motor's stop-current adjustment control in the counterclockwise direction reduces the current. One-half the value displayed on the ammeter is the current per phase of the motor.

(Example: 2.8 A = 1.4 A/phase)

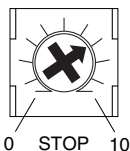
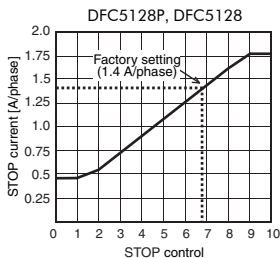
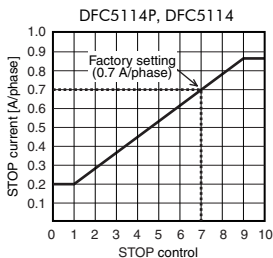
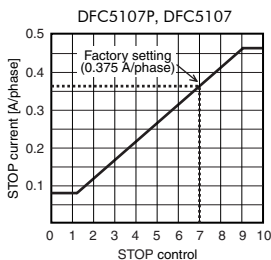
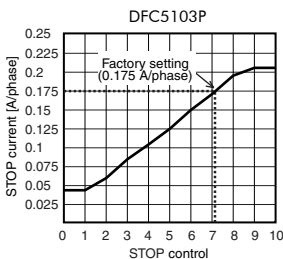

The scale values are not displayed on the control.

The motor's current will automatically drop to the motor's stop current within approximately 0.1 sec. after the pulse input has stopped.

### Note

When adjusting the motor's stop current, set the current to within 50% of the specified motor's running current. Failure to do so may result in damage to the motor and/or driver. On the other hand, setting the motor's stop current too low may cause trouble with the motor's startup or holding torque.

---

## Pulse input modes

Set the pulse input mode switch to either 2-pulse input mode or 1-pulse input mode, whichever the controller uses.

### Note

Set the pulse input mode switch when the driver power is off.

Factory setting      [2P: 2-pulse input mode]

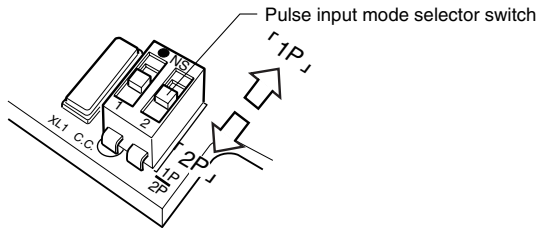

### ■Setting 2-pulse input mode

When operating the motor with two pulses (CW pulse input and CCW pulse input) switch the pulse input mode selector switch to the "2P".

### ■Setting 1-pulse input mode

When operating the motor with pulse input and rotation-direction input, switch the pulse input mode selector switch to the "1P".



---

# Inspection

It is recommended that periodic inspections be conducted for the items listed below after each operation of the motor. If an abnormal condition is noted, stop the use and contact your nearest office.

## Inspection Items

- Are the motor installation screws loose?
- Are there any abnormal sounds from the motor's bearing section (ball bearings) or elsewhere?
- Do any of the motor leads have damage or stress, or is there any play at the section for connection with the driver?
- Is there any deviation between the centers of the motor's output shaft and load shaft?
- Are the driver installation screws or connector sections loose?
- Is there any dust or dirt on the driver?
- Are there any strange smells or other abnormalities at the driver's power transistors or capacitors?

## Note

- The driver uses semiconductor elements. Handle the driver carefully. There is a danger of the driver being damaged by static electricity, etc.
- Never measure insulation resistance or withstand voltage with the motor and driver connected.

# Troubleshooting and remedial actions

During the motor operation, the motor or driver may fail to function properly due to an incorrect speed setting or wiring. When the motor cannot be operated correctly, refer to the contents provided in this section and take appropriate action. If the problem persists, contact your nearest office.

Phenomenon	Possible cause	Remedial action
The motor windings are not excited, allow the motor to be turned by hand.	Connection error in the motor lead or power cable	Double-check that the connections between the driver, motor and power supply are correct.
	Current-adjustment control incorrectly set If the setting is too low, the motor torque will also be too low and operation will be unstable.	Return the current-adjustment control to its factory setting and check.
	The A.W.OFF input is set to "ON."	Turn the A.W.OFF input to "OFF" and confirm that the motor windings are excited.
The motor does not run.	Pulse input line connection error	<ul style="list-style-type: none"> <li>• Check the controller and driver connections.</li> <li>• Check the pulse input specifications (voltage and width).</li> </ul>
	During 2-pulse input, the CW input and the CCW input came on at the same time.	Input either the CW input or the CCW input, and always switch the other terminal to "OFF."
	During 1-pulse input, the pulses are connected to the DIR input (pin Nos. 3 and 4).	Connect the pulses to the PLS input (pin Nos.1 and 2).
The motor rotates in the direction opposite that which is specified.	With 2-pulse input selected, the CW input and the CCW input are connected in reverse.	Connect the CW pulses to the CW input (pin Nos. 1 and 2), and connect the CCW pulses to the CCW input (pin Nos. 3 and 4).
	With 1-pulse input selected, the DIR input setting is reversed.	Set the rotation-direction input to "ON" when setting the clockwise direction; set the rotation direction input to "OFF" when setting the counterclockwise direction.

Phenomenon	Possible cause	Remedial action
Motor operation is unstable.	Error in the motor's cable connection	Double-check that the driver and motor connections are correct.
	Current-adjustment control incorrectly set If the setting is too low, the motor torque will also be too low and operation will be unstable.	Return the current-adjustment controls to its factory setting and check.
	Pulse input line connection defect	<ul style="list-style-type: none"> <li>• Check the controller and driver connections.</li> <li>• Check the pulse input specifications (voltage and width).</li> </ul>
Loss of synchronization during acceleration or running	The centers of the motor's output shaft and load shaft are not aligned.	Check the linkage state for the motor's output shaft and load shaft.
	The load or load fluctuation is too high.	Check for large load fluctuations during motor operation. If adjusting the motor's operating speed to low and high torque eliminates the problem, it is necessary to review the load conditions.
	The speed of the starting pulse is too high.	Lower the speed of the starting pulse and set it again to a speed at which stable starting is possible.
	The acceleration (deceleration) time is too short.	Lengthen the acceleration (deceleration) time in order to reset it to a time at which stable starting is possible.
	Electrical noise	Check running with only the motor, driver and required controller. If the impact of noise is recognized, take countermeasures, such as rewiring for greater distance from the noise source, changing the signal cables to shielded wire, or mounting a ferrite core.
Motor does not move the set amount.	Mistake in switching C/S (step angle switching) input	Check the step angle setting switch (DATA1, DATA2) settings and the C/S input switching state.
	Pulse output count is too low or too high.	Check whether or not the number of pulses required for operation at the set step angle are being output.
Current does not drop when the motor stops.	Current-check switch to "ON"	Switch the current check switch to "OFF."
	CW input, CCW input or pulse input set to "ON" after pulses have stopped	After the pulses stop, always switch to "OFF."

Phenomenon	Possible cause	Remedial action
Excessive vibration	The centers of the motor's output shaft and load shaft are not aligned.	Check the linkage state for the motor's output shaft and load shaft.
	Motor resonating	If changing the running pulse speed reduces the vibration, the motor is resonating. Either change the speed setting of the running pulse or reduce the step angle setting.
	Small load	Turn the motor-run current-adjustment controls slightly in the counterclockwise direction in order to lower the current. Vibration will increase if the motor's output torque is too large for the load.
Motor too hot	Motor run time too long	Either shorten the motor's run time or lengthen the stop time. Hold the motor case temperature to a maximum of 100°C.
	Current check switch switched to "ON"	Switch the current check switch to "OFF."
	Motor-stop current adjustment too high	Adjust the motor stop current to a maximum of one-half the value of the run current.
Timing output not output	C/S (step angle switching) input switched to "ON" when timing output is not being output	Switch the C/S input to "ON" when timing output is being output.

---

# Option

## ■ Motor cable

Used for connecting the motor of the standard **P** type.

Model	Length	Applicable type
<b>LC5N06A</b>	0.6 m	<b>CFK513</b> type
<b>LC5N10A</b>	1 m	

## ■ Driver cable

A set of 3 cables is provided to connect the power, I/O and motor, respectively.

Model	Length	Applicable type
<b>LCS02CFK</b>	0.6 m	<b>CFK513, CFK523, CFK525, CFK543, CFK544, CFK545, CFK564, CFK566, CFK569</b> type
<b>LCS03CFK</b>	0.6 m	<b>CFK566H, CFK569H, CFK596H, CFK599H, CFK5913H</b> type





- Unauthorized reproduction or copying of all or part of this manual is prohibited. If a new copy is required to replace an original manual that has been damaged or lost, please contact your nearest Oriental Motor branch or sales office.
- Oriental Motor shall not be liable whatsoever for any problems relating to industrial property rights arising from use of any information, circuit, equipment or device provided or referenced in this manual.
- Characteristics, specifications and dimensions are subject to change without notice.
- While we make every effort to offer accurate information in the manual, we welcome your input. Should you find unclear descriptions, errors or omissions, please contact the nearest office.
- ***Oriental motor*** is registered trademark or trademark of Oriental Motor Co., Ltd., in Japan and other countries.

Other product names and company names mentioned in this manual may be trademarks or registered trademarks of their respective companies and are hereby acknowledged. The third-party products mentioned in this manual are recommended products, and references to their names shall not be construed as any form of performance guarantee. Oriental Motor is not liable whatsoever for the performance of these third-party products.

© Copyright ORIENTAL MOTOR CO., LTD. 2008

• Please contact your nearest Oriental Motor office for further information.

ORIENTAL MOTOR U.S.A. CORP  
 Technical Support Tel:(800)468-3982  
 8:30 A.M. to 5:00 P.M., P.S.T. (M-F)  
 7:30 A.M. to 5:00 P.M., C.S.T. (M-F)  
[www.orientalmotor.com](http://www.orientalmotor.com)

ORIENTAL MOTOR DO BRASIL LTDA.  
 Tel:+55-11-3266-6018  
[www.orientalmotor.com.br](http://www.orientalmotor.com.br)

ORIENTAL MOTOR (EUROPA) GmbH  
 Schiessstraße 74, 40549 Düsseldorf, Germany  
 Technical Support Tel:00 800/22 55 66 22  
[www.orientalmotor.de](http://www.orientalmotor.de)

ORIENTAL MOTOR (UK) LTD.  
 Tel:01 256-347090  
[www.oriental-motor.co.uk](http://www.oriental-motor.co.uk)

ORIENTAL MOTOR (FRANCE) SARL  
 Tel:01 47 86 97 50  
[www.orientalmotor.fr](http://www.orientalmotor.fr)

ORIENTAL MOTOR ITALIA s.r.l.  
 Tel:02-93906346  
[www.orientalmotor.it](http://www.orientalmotor.it)

ORIENTAL MOTOR ASIA PACIFIC PTE. LTD.  
 Singapore  
 Tel:1800-8420280  
[www.orientalmotor.com.sg](http://www.orientalmotor.com.sg)

ORIENTAL MOTOR (MALAYSIA) SDN. BHD.  
 Tel:1800-806161  
[www.orientalmotor.com.my](http://www.orientalmotor.com.my)

ORIENTAL MOTOR (THAILAND) CO., LTD.  
 Tel:1800-888-881  
[www.orientalmotor.co.th](http://www.orientalmotor.co.th)

ORIENTAL MOTOR (INDIA) PVT. LTD.  
 Tel:+91-80-41125586  
[www.orientalmotor.co.in](http://www.orientalmotor.co.in)

TAIWAN ORIENTAL MOTOR CO., LTD.  
 Tel:0800-060708  
[www.orientalmotor.com.tw](http://www.orientalmotor.com.tw)

SHANGHAI ORIENTAL MOTOR CO., LTD.  
 Tel:400-820-6516  
[www.orientalmotor.com.cn](http://www.orientalmotor.com.cn)

INA ORIENTAL MOTOR CO., LTD.  
 Korea  
 Tel:080-777-2042  
[www.inaom.co.kr](http://www.inaom.co.kr)

ORIENTAL MOTOR CO., LTD.  
 Hong Kong Branch  
 Tel:+852-2427-9800

ORIENTAL MOTOR CO., LTD.  
 4-8-1 Higashiueno, Taito-ku, Tokyo  
 110-8536 Japan  
 Tel:03-6744-0361  
[www.orientalmotor.co.jp](http://www.orientalmotor.co.jp)