

Chapter	Description	Page	Chapter	Description	Page
1	Symbols and units of measurement	2	9	AC brake motors type BN_FA	31
2	Introduction	3	9.1	Degree of protection	31
3	General characteristics	5	9.2	FA brake power supply FA	32
3.1	Production range	5	9.3	Technical specifications of FA brakes	32
3.2	Standards	5	9.4	FA brake connections	33
3.3	Directives 2006/95/EC (LVD) and 2004/108/EC (EMC)	6	10	Brake release systems	34
3.4	Tolerances	6	10.1	Release lever orientation	35
4...4.2	Motor designation	7	11	Options	36
4.3	Variants	8	11.1	Soft-start / stop	36
4.4	Options	10	11.2	Capacitive filter	36
4.5	Brake-related options	11	11.3	Thermal protective devices	36
4.6	Example of identification plate	11	11.4	Thermistors	36
5	Mechanical features	12	11.5	Bimetallic thermostates	37
5.1	Versions	12	11.6	Plug connector	37
5.2	Degree of protection	13	11.7	Control of brake operation	40
5.3	Cooling	14	11.8	Additional cable entry for brakemotors	40
5.4	Direction of rotation	15	11.9	Anti-condensation heaters	40
5.5	Noise	15	11.10	Tropicalization	41
5.6	Vibrations and balancing	15	11.11	Second shaft extension	41
5.7	Terminal box	15	11.12	Rotor balancing	41
5.8	Cable entry	16	11.13	Ventilation	42
5.9	Bearings	16	11.14	Rain canopy	44
6	Electrical characteristics	17	11.15	Textile canopy	44
6.1	Voltage	17	11.16	Feedback units	44
6.2	Frequency	18	11.17	Surface protection	46
6.3	Ambient temperature	19	11.18	Painting	46
6.4	50 HZ normalized power	19	11.19	Certificates	47
6.5	Motors for USA and Canada	19	12	Tables of motors correlation	47
6.6	China Compulsory Certification	20	13	Motor rating charts BX	49
6.7	Insulation class	20	14	Motors dimensions BX	50
6.8	Type of duty	21	15	Motor rating charts BE	53
6.9	Inverter-controlled motors	22	16	Motors dimensions BE	55
6.10	Permissible starts per hour, Z	23	17	Motor rating charts BN	58
7	Asynchronous brake motors	25	18	Motors dimensions BN	68
7.1	Operation	25			
7.2	Most significant features	25			
8	DC brake motors type BN_FD	26			
8.1	Degree of protection	27			
8.2	FD brake power supply	27			
8.3	FD brake technical specifications	29			
8.4	FD brake connections	29			

## Revisions

Refer to page 78 for the catalogue revision index. Visit [www.bonfiglioli.com](http://www.bonfiglioli.com) to search for catalogues with up-to-date revisions.

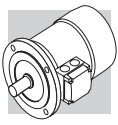

## 1 SYMBOLS AND UNITS OF MEASUREMENT

Symbols	Units of Measure	Description	Symbols	Units of Measure	Description
$\cos\varphi$	–	Power factor	$n$	[min <sup>-1</sup> ]	Rated speed
$\eta$	–	Efficiency	$P_B$	[W]	Power drawn by the brake at 20°C
$f_m$	–	Power adjusting factor	$P_n$	[kW]	Motor rated power
$I$	–	Cyclic duration factor	$P_r$	[kW]	Required power
$I_N$	[A]	Rated current	$t_1$	[ms]	Brake response time with one-way rectifier
$I_S$	[A]	Locked rotor current	$t_{1s}$	[ms]	Brake response time with electronic-controlled rectifier
$J_C$	[Kgm <sup>2</sup> ]	Load moment of inertia	$t_2$	[ms]	Brake reaction time with a.c. disconnect
$J_M$	[Kgm <sup>2</sup> ]	Moment of inertia	$t_{2c}$	[ms]	Brake reaction time with a.c. and d.c. disconnect
$K_c$	–	Torque factor	$t_a$	[°C]	Ambient temperature
$K_d$	–	Load factor	$t_f$	[min]	Work time at constant load
$K_J$	–	Inertia factor	$t_r$	[min]	Rest time
$M_A$	[Nm]	Mean breakaway torque	$W$	[J]	Braking work between service interval
$M_B$	[Nm]	Brake torque	$W_{max}$	[J]	Maximum brake work for each braking
$M_N$	[Nm]	Rated torque	$Z$	[1/h]	Permissible starting frequency, loaded
$M_L$	[Nm]	Counter-torque during acceleration	$Z_0$	[1/h]	Max. permissible unloaded starting frequency (I = 50%)
$M_S$	[Nm]	Starting torque			

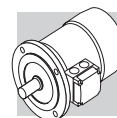

## 2 INTRODUCTION

### Efficiency classes and test methods

Efficiency classes characterise the efficiency with which an electric motor converts electrical energy into mechanical energy. In Europe, the energy efficiency of low voltage electric motors used to be classified using the voluntary Eff1/Eff2/Eff3 system. Outside Europe, other countries used to apply their own national systems, often very different to the European system. This uncertainty in standards led manufacturers to develop a harmonised international standard, and push for the issue of IEC (International Electrotechnical Commission) standard IEC 60034-30-1 “Efficiency classes of single-speed, three-phase, cage-induction motors (IE code)”.

This new standard:

- defines new classes of efficiency
  - IE1** (standard efficiency)
  - IE2** (high efficiency)
  - IE3** (premium efficiency)
- provides a common, international reference system for the classification of electric motors and for national legislation
- introduces a new efficiency measurement method in conformity with standard IEC 60034-1-2:2007

The following table shows the correspondence among the main classes.

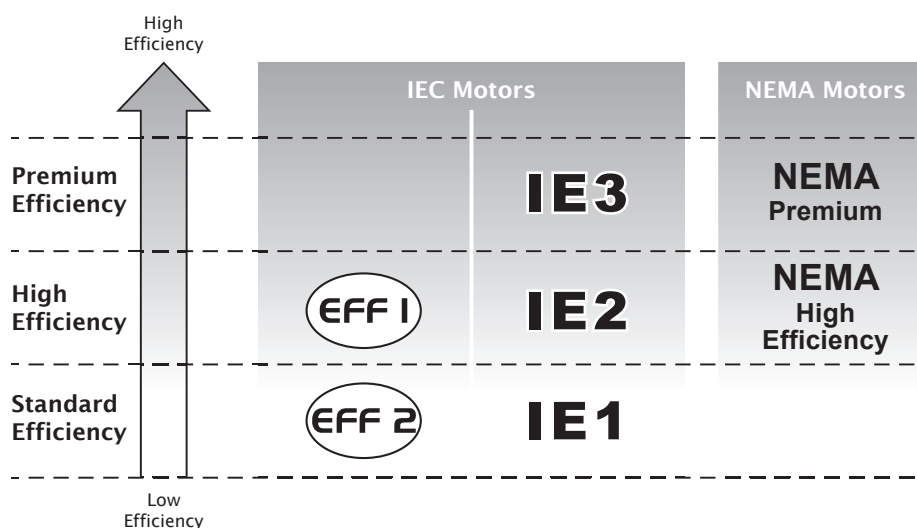

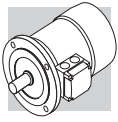

### European Commission regulation 640/2009

IEC standard 60034-30-1 establishes technical guidelines for efficiency classification but does not impose any legal requirements for the adoption of any particular efficiency class. These are laid down by European Directives and national laws.

The EC Regulation applying Directive 2005/32/EC was adopted on the 22nd July 2009. This establishes the legal requirements and eco-compatible design criteria for electric motors, and imposes minimum efficiency limits according to the following schedule:

- **16/06/2011:** Electric motors must have a minimum efficiency level equivalent to class **IE2**
- **01/01/2015:** Electric motors with a rated power output between 7.5 kW and 375 kW must have a minimum efficiency level corresponding to **IE3**, or to **IE2** if controlled by an inverter.
- **01/01/2017:** Electric motors with a rated power output between 0.75 kW and 375 kW must have a minimum efficiency level corresponding to **IE3**, or to **IE2** if controlled by an inverter.

### Scope and exclusions

EC Regulation 640/2009 applies to 2, 4, and 6 pole, single-speed, three-phase, 50 Hz or 60 Hz, cage-induction motors with rated outputs of 0.75 kW to 375 kW, and rated voltage up to 1000 V, designed for continuous duty (S1).

The regulation does not apply to:

- brakemotors
- motors designed to function immersed in liquid
- motors that are fully integrated in a product (like a gearbox, pump, fan), so that it is not possible to test the performance of the motor independently of that of the product.
- motors expressly designed to function:
  - at altitudes above 4000 metres a.s.l.;
  - in ambient temperatures above 60 °C;
  - at maximum operating temperatures above 400 °C;
  - in ambient temperatures below -30 °C (all motors) or below 0 °C (water-cooled motors);
  - with incoming liquid coolants at temperatures below 0 °C or above 32 °C;
  - in potentially explosive atmospheres as defined by Directive 2014/34/EU.

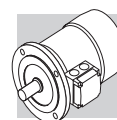

### 3 GENERAL CHARACTERISTICS

#### 3.1 Production range

The asynchronous three-phase electric motors BX, BE, BN of BONFIGLIOLI RIDUTTORI's production, are available in basic designs IMB3, IMB5 and IMB14 and derived versions, with the following polarities: 2, 4, 6, 2/4, 2/6, 2/8, 2/12.

Motors are the enclosed type with outer fan and cage-type rotor for use in industrial environments. Standard versions of BX/BE motors are 230/400V  $\Delta/Y$  (400/690V  $\Delta/Y$  in sizes BX/BE 160 and BX/BE 180), 50 Hz motors, with a tolerance of  $\pm 10\%$ . Standard BN motors are designed to operate from a rated voltage 230/400V  $\Delta/Y$  (400/690V  $\Delta/Y$  for frame sizes BN 160 through BN 200) 50 Hz, with  $\pm 10\%$  tolerance.

#### 3.2 Standards

The motors described in this catalogue are manufactured to the applicable standards shown in the following table.

(F01)

Title	CEI	IEC
General requirements for rotating electrical machines	CEI EN 60034-1	IEC 60034-1
Terminal markings and direction of rotation of rotating machines	CEI 2-8	IEC 60034-8
Methods of cooling for electrical machines	CEI EN 60034-6	IEC 60034-6
Dimensions and output ratings for rotating electrical machines	EN 50347	IEC 60072
Classification of degree of protection provided by enclosures for rotating machines	CEI EN 60034-5	IEC 60034-5
Noise limits	CEI EN 60034-9	IEC 60034-9
Classification of type of construction and mounting arrangements	CEI EN 60034-7	IEC 60034-7
Rated voltage for low voltage mains power	CEI 8-6	IEC 60038
Vibration level of electric machines	CEI EN 60034-14	IEC 60034-14
Efficiency classes of single-speed, three-phase, cage-induction motors (IE code)	CEI EN 60034-30-1	IEC 60034-30-1
Standard method for determining losses and efficiency from tests	CEI EN 60034-2-1	IEC 60034-2-1

The motors also comply with foreign standards adapted to IEC 60034-1 as shown here below.

(F02)

DIN VDE 0530	Germany
BS5000 / BS4999	Great Britain
AS 1359	Australia
NBNC 51 - 101	Belgium
NEK - IEC 34	Norway
NF C 51	France
OEVE M 10	Austria
SEV 3009	Switzerland
NEN 3173	Netherlands
SS 426 01 01	Sweden

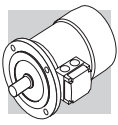

### 3.3 Directives 2006/95/EC (LVD) and 2004/108/EC (EMC)

BX, BE, BN motors meet the requirements of Directives 2006/95/EC (Low Voltage Directive) and 2004/108/EC (Electromagnetic Compatibility Directive) and their name plates bear the CE mark. As for the EMC Directive, construction is in accordance with standards CEI EN 60034-1, EN 61000-6-2, EN 61000-6-4.

Motors with FD brakes, when fitted with the suitable capacitive filter at rectifier input (option **CF**), meet the emission limits required by Standard EN 61000-6-3:2007 "Electromagnetic compatibility - Generic Emission Standard - Part 6-3 Residential, commercial and light industrial environment". Motors also meet the requirements of standard CEI EN 60204-1 "Electrical equipment of machines". The responsibility for final product safety and compliance with applicable directives rests with the manufacturer or the assembler who incorporate the motors as component parts.

### 3.4 Tolerances

As per the Norms CEI EN 60034-1, applicable the tolerances here below apply to the following quantities.

(F03)

$-0.15 (1 - \eta) \quad P \leq 50\text{kW}$	Efficiency
$-(1 - \cos\phi)/6 \quad \text{min } 0.02 \quad \text{max } 0.07$	Power factor
$\pm 20\% \quad *$	Slip
+20%	Locked rotor current
-15% +25%	Locked rotor torque
-10%	Max. torque

(\*)  $\pm 30\%$  for motors with  $P_n < 1 \text{ kW}$

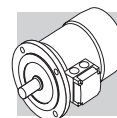

## 4 PREMIUM EFFICIENCY MOTOR DESIGNATION

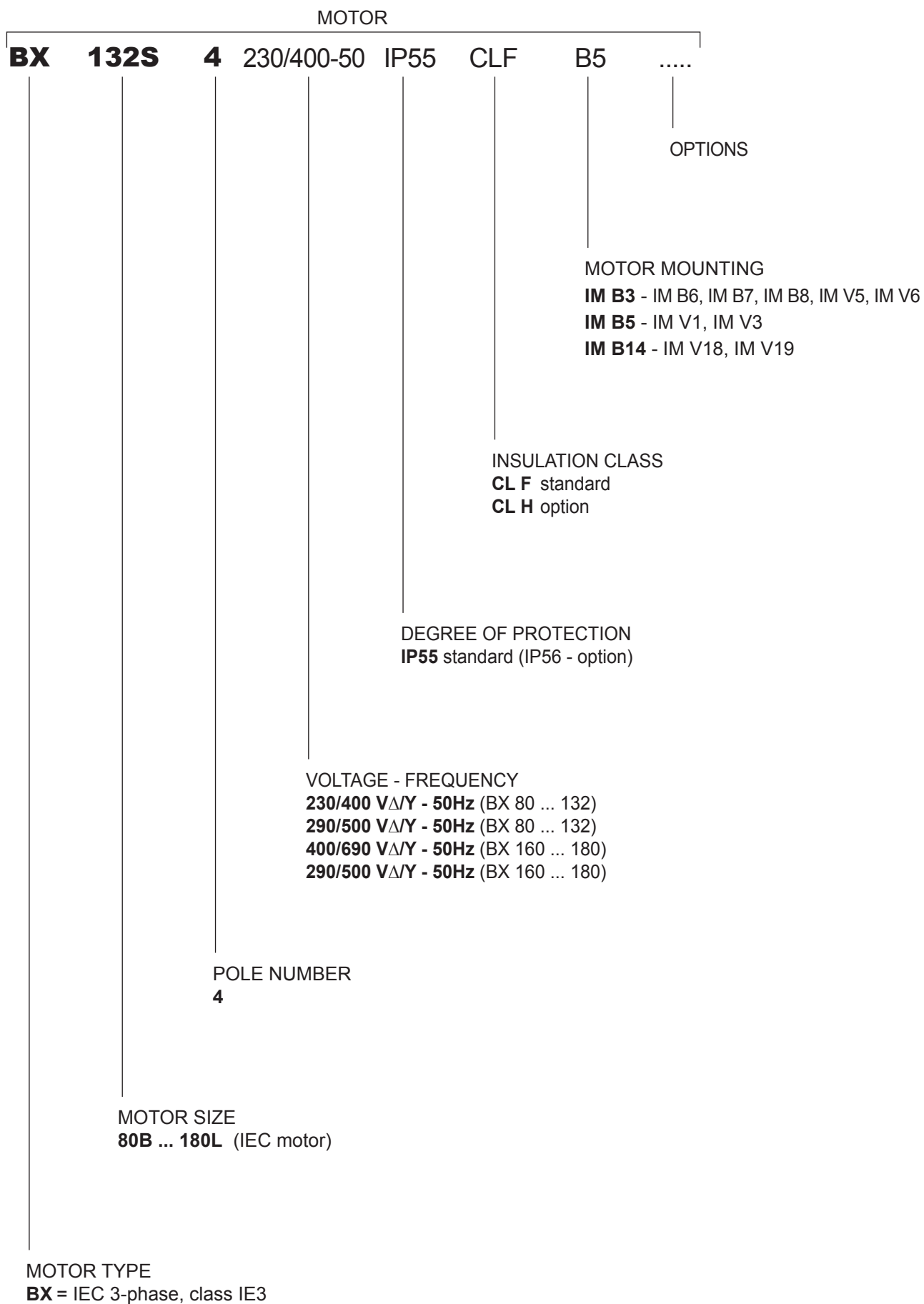

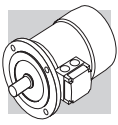

## 4.1 HIGH EFFICIENCY MOTOR DESIGNATION

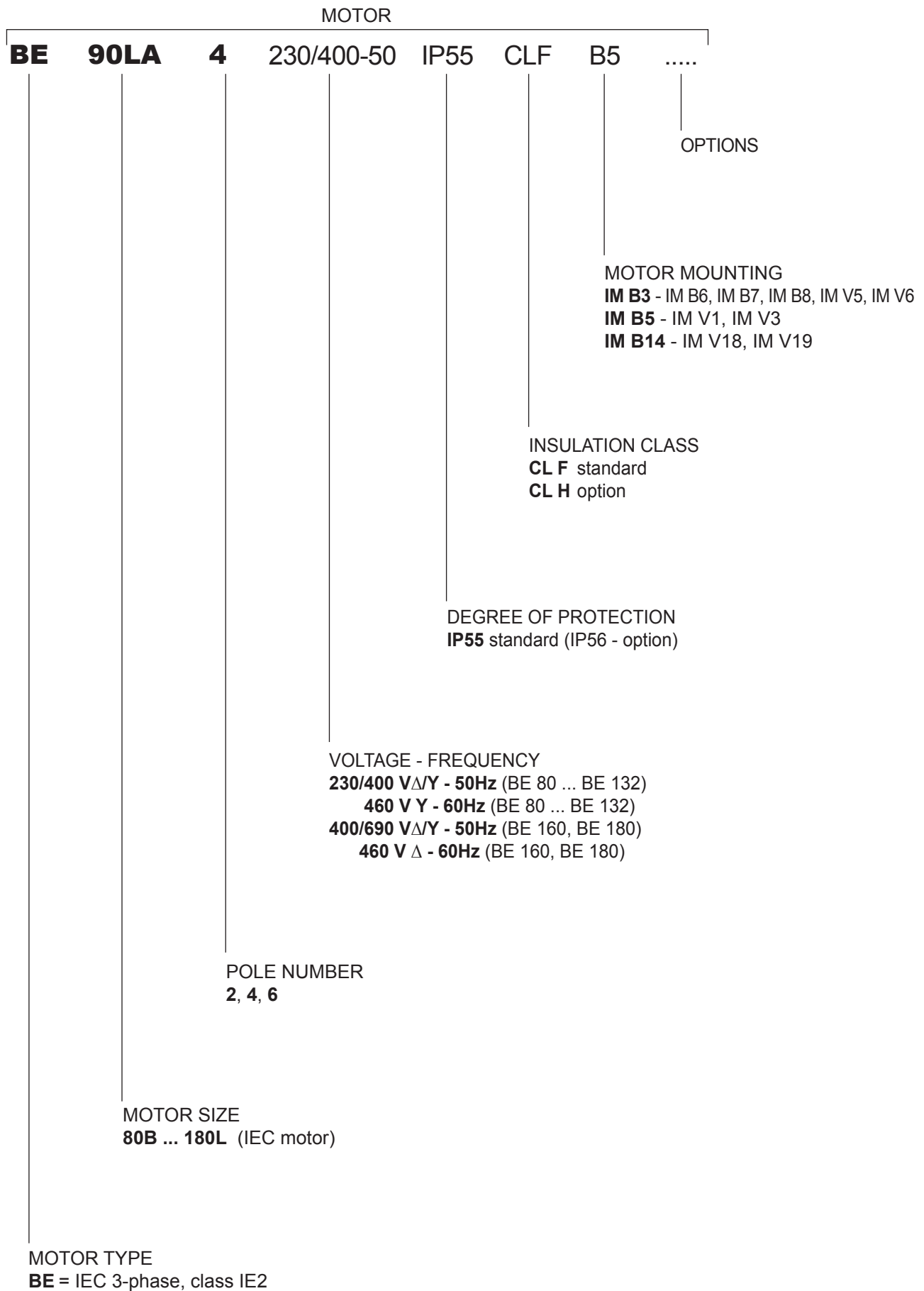



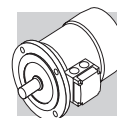

4.2 STANDARD EFFICIENCY MOTOR DESIGNATION

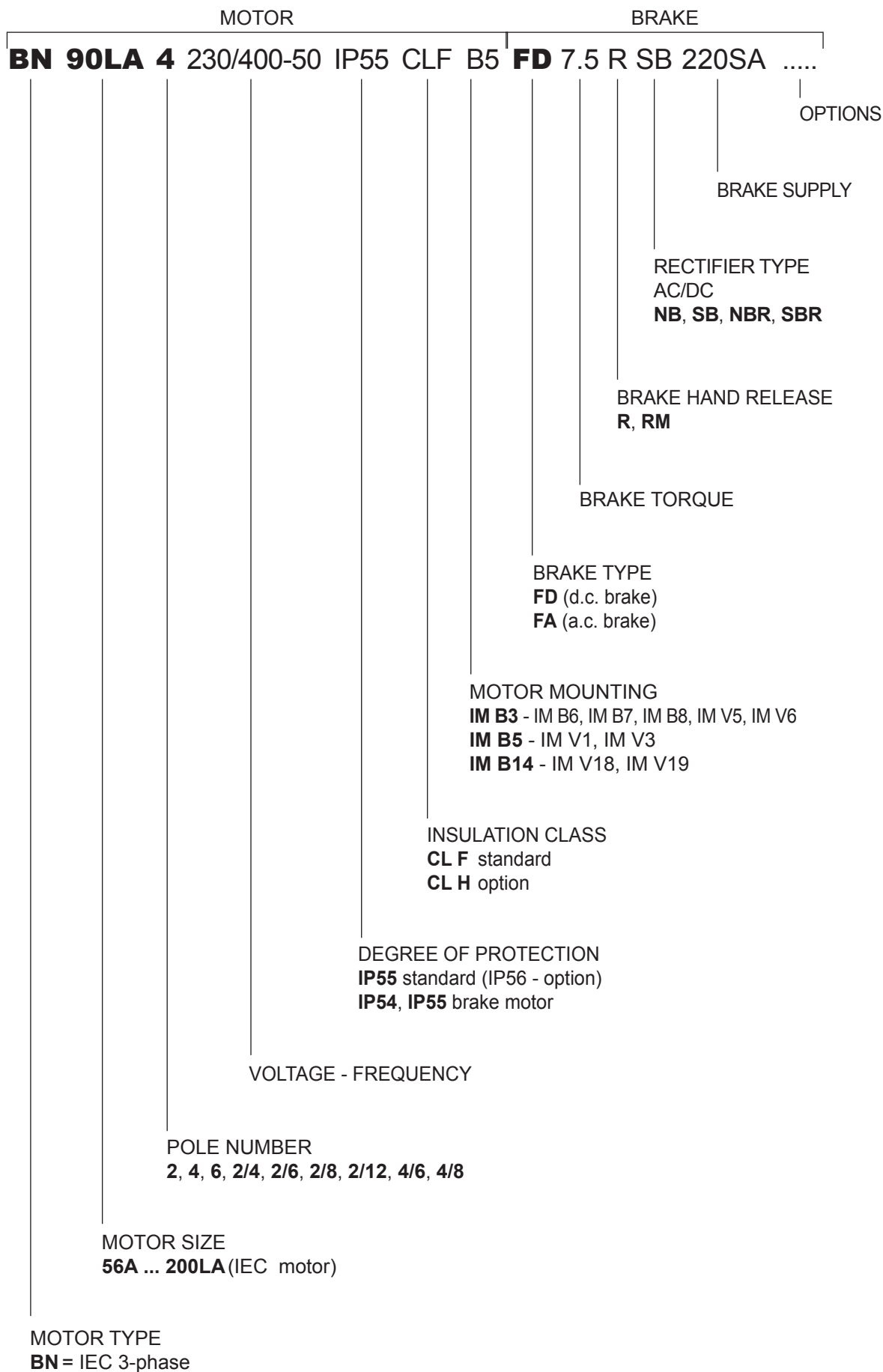

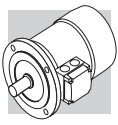

### 4.3 Variants

(F04)

Description		Default	Option		Page
Voltage		230/400/50			17
Protection class	BX - BE - BN	IP 55	IP 56		13
	BN_FD - BN_FA	IP 54	IP 55		
Insulation class		CLF	CLH		20 21
Design version	BX - BE - BN	<b>B5</b> <b>B5 R</b>	<b>B14</b> <b>B14 R</b>	<b>B3</b>	12

Default values.

### 4.4 Options

(F05)

Description	Catalogue numbers						Availability	Page	
	D3	K1	E3						
Thermal protective devices	<b>D3</b>	<b>K1</b>	<b>E3</b>				BX - BE - BN	36	37
50 Hz normalized power	<b>PN</b>						BN	19	
Feedback devices	<b>EN1</b>	<b>EN2</b>	<b>EN3</b>	<b>EN4</b>	<b>EN5</b>	<b>EN6</b>	BX - BE - BN	44	45
Anti-condensate heaters	<b>H1</b>	<b>NH1</b>					BX - BE - BN	40	
Tropicalized windings	<b>TP</b>						BX - BE - BN	41	
Double-extended shaft	<b>PS</b>						BX - BE - BN	41	
Rotor balancing grade B	<b>RV</b>						BX - BE - BN	41	
External mechanical protections	<b>RC</b>	<b>TC</b>					BX - BE - BN	44	
Forced ventilation	<b>U1</b>	<b>U2*</b>					BX - BE - BN	43	
Certification	<b>CUS</b>						BE - BN	19	
China Compulsory Certification	<b>CCC</b>						BE - BN	20	
Plug connector	<b>CON</b>						BX - BE - BN	37	
Surface protection	<b>C_</b>						BX - BE - BN	46	
Painting	<b>RAL</b>						BX - BE - BN	46	
Certificates	<b>ACM</b>						BX - BE - BN	47	
Inspection certificate	<b>CC</b>						BX - BE - BN	47	
Type of duty	<b>S2</b>	<b>S3</b>	<b>S9</b>				BN	21	

\* Only for motors BN and M

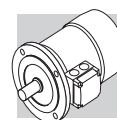

## 4.5 Brake-related options

(F06)

Description	Catalogue numbers				Availability	Page
Brake torque	Refer to the specific brake type					29 32
Manual release lever	<b>R</b>	<b>RM</b>			BN	34
Release lever orientation	<b>AB</b>	<b>AA</b>	<b>AC</b>	<b>AD</b>	BN	35
DC brake rectifier	<b>NB</b>	<b>NBR</b>	<b>SB</b>	<b>SBR</b>	BN	27
Soft-start flywheel	<b>F1</b>				BN	36
Capacitive filter	<b>CF</b>				BN	36
Brake separate power supply (*)	<b>...SA</b>	<b>...SD</b>			BN	27 32
Brake functionality check	<b>MSW</b>				BN	40
Additional cable entry for brake motors	<b>IC</b>				BN	40

(\*) Specify voltage.

■ Default values.

## 4.6 Example of identification plate

IEC EN 60034		<b>Bonfiglioli</b> Riduttori		CE	
3~Mot BE 90LA 4		Cod. 8U09030001			
No 1003001 - 6954785		S1 IM B5 15,1 kg			
kW 1,5		CL F IP 55 Amb 40 °C			
Hz	V ± 10%	A	min <sup>-1</sup>	cos φ	
50 ○	230/400 Δ/Y	6.1/3.5	1430	○ 0.74	
60	265/460 Δ/Y	5.4/3.1	1730	0.73	
50Hz-IE2	83.5(100%) - 83.0(75%) - 80.0(50%)				
60Hz-IE2	84.5(100%) - 83.9(75%) - 80.7(50%)				

- ① BONFIGLIOLI  
Motor type
- ② Serial number
- ③ Rated voltage

- ④ Motor code
- ⑤ Type of duty: S1  
Continuous duty
- ⑥ IE Class, Efficiency at:  
4/4 - 3/4 - 2/4 load

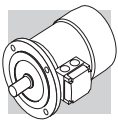

## 5 MECHANICAL FEATURES

### 5.1 Versions

EC-normalised BX, BE and BN motors are available in the design versions as indicated in the table below here after as per Standards EN 60034-7 (BX/BE), CEI EN 60034-14 (BN).

Mounting versions are:

**IM B3** (basic)

IM B6, IM B7, IM B8, IM V5, IM V6 (derived)

**IM B5** (basic)

IM V1, IM V3 (derived)

**IM B14** (basic)

IM V18, IM V19 (derived)

IM B3 design motors can be installed in positions IM B6, IM B7, IM B8, IM V5 and IM V63; IM B5 design motors can be installed in positions IM V1 and IM V3; IM B14 design motors can be installed in positions IM V18 and IM V19.

In such cases, the basic design IM B5 or IM B14 is indicated on the motor name plate.

In design versions with a vertically located motor and shaft downwards, it is recommended to request the drip cover (always necessary for brake motors). This facility, included in the option list should be specified when ordering as it does not come as a standard device

(F07)

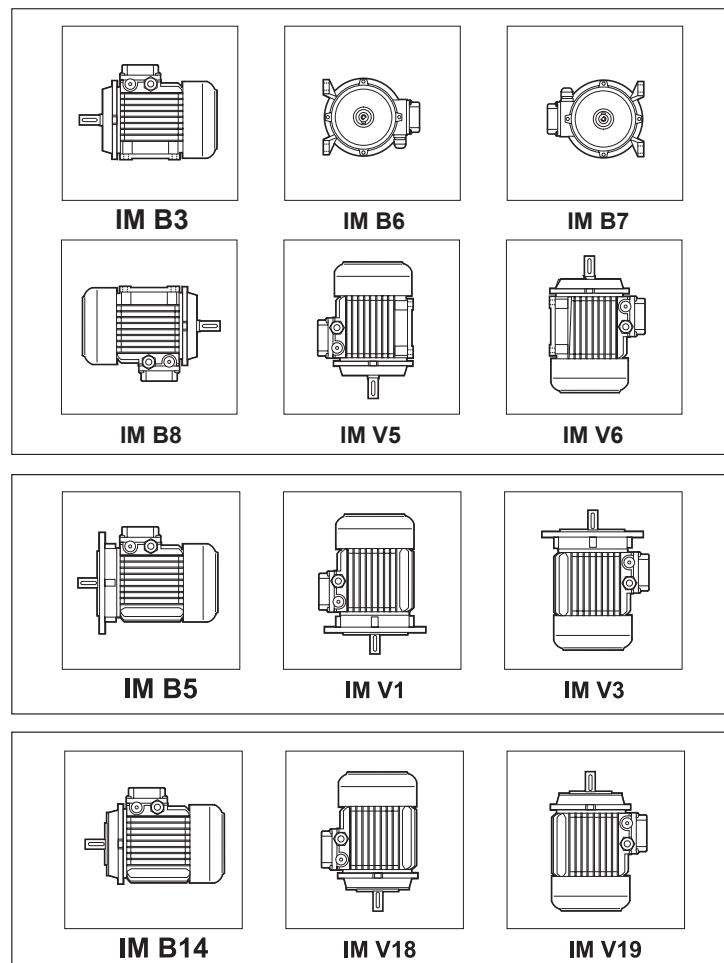

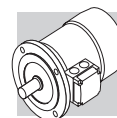

Flange output motors are also available with reduced coupling dimensions, as indicated in the table below - executions **B5R**, **B14R**.

(F08)

	<b>BN 71</b>	<b>BX/BE/BN 80</b>	<b>BX/BE/BN 90</b>	<b>BX/BE/BN 100</b>	<b>BX/BE/BN 112</b>	<b>BX/BE/BN 132</b>
	DxE - Ø					
<b>B5R</b> <sup>(1)</sup>	11x23 - 140	14x30 - 160	19x40 - 200	24x50 - 200	24x50 - 200	28x60 - 250
<b>B14R</b> <sup>(2)</sup>	11x23 - 90	14x30 - 105	19x40 - 120	24x50 - 140	—	—

(1) flange with through holes  
 (2) flange with threaded holes

## 5.2 Degree of protection









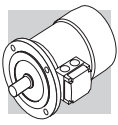



**IP..**

The following chart provides an overview of the degrees of protection available. In addition to the degree of protection specified when ordering, motors to be installed outdoors require protection against direct sunlight and also – when they are to be installed vertically down – a drip cover to prevent the ingress of water and solid particles (option **RC**).

(F09)

	<b>IP 54</b>	<b>IP 55</b>	<b>IP 56</b>
<b>BX - BE - BN</b>		standard	
<b>BN_FD BN_FA</b>	standard		

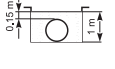
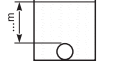

<b>IP</b>		<b>5</b>	<b>5</b>		
<b>0</b>		Not protected	<b>0</b>		Not protected
<b>1</b>		Protected against extraneous solid bodies having $\varnothing \geq 50$ mm	<b>1</b>		Protected against vertical water drips
<b>2</b>		Protected against extraneous solid bodies having $\varnothing \geq 12.5$ mm	<b>2</b>		Protected against vertical water drips inclined up to 15°
<b>3</b>		Protected against extraneous solid bodies having $\varnothing \geq 2.5$ mm	<b>3</b>		Protected against rain
<b>4</b>		Protected against extraneous solid bodies having $\varnothing \geq 1.0$ mm	<b>4</b>		Protected against water splashes
<b>5</b>		Protected against dust	<b>5</b>		Protected against jets of water
<b>6</b>		No dust ingress	<b>6</b>		Protected against powerful jets of water
			<b>7</b>		Protected against the effects of temporary immersion
			<b>8</b>		Protected against the effects of continuous immersion

### 5.3 Cooling

The motors are externally ventilated (IC 411 to CEI EN 60034-6) and are equipped with a plastic fan working in both directions.

The motors must be installed allowing sufficient space between fan cowl and the nearest wall to ensure free air intake and allow access for maintenance purposes on motor and brake, if supplied. Independent, forced air ventilation (IC 416) can be supplied on request (option **U1**).

This solution enables to increase the motor duty factor when driven by an inverter and operating at reduced speed.

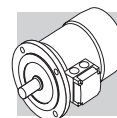

## 5.4 Direction of rotation

Rotation is possible in both directions. If terminals U1, V1, and W1 are connected to line phases L1, L2 and L3, clockwise rotation (looking from drive end) is obtained. For counterclockwise rotation, switch two phases.

## 5.5 Noise

Noise levels, measured using the method prescribed by ISO 1680 Standards, are within the maximum levels specified by Standards CEI EN 60034-9.

## 5.6 Vibrations and balancing

Rotor shafts are balanced with half key fitted and fall within the vibration class N, as per Standard CEI EN 60034-14.

## 5.7 Terminal box

Terminal board features 6 studs for eyelet terminal connection. A ground terminal is also supplied for earthing of the equipment. Terminals number and type are shown in the following table.

For brake power supply, please read par. 8 (brake FD), 9 (brake FA).

In motor design IM B3, the terminal box is at the top (side opposite to feet).

Brakemotors house the a.c./d.c. rectifier (factory pre-wired) inside the terminal box.

Wiring instructions are provided either in the box or in the user manual.

(F10)

	No. of terminals	Terminal threads	Wiremax cross section area sq mm <sup>2</sup>
<b>BX 80, BX 90 BE 80, BE 90 BN 56 ... BN 90</b>	6	M4	2.5
<b>BX 100 ... BX 132 BE 100 ... BE 132 BN 100 ... BN 160MR</b>	6	M5	6
<b>BX 160 - BE 160 ... BE 180M BN 160M ... BN 180M</b>	6	M6	16
<b>BX 180 - BE 180L BN 180L ... BN 200L</b>	6	M8	25
<b>BX 80 ... BX 132 BE 80 ... BE 132 BN 63 ... BN 160MR</b>	9	M4	6
<b>BX 160 ... BX 180 BE 160 ... BE 180 BN 160M ... BN 200</b>	9	M6	16

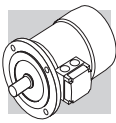

## 5.8 Cable entry

The holes used to bring cables to terminal boxes use metric threads in accordance with standard EN 50262 as indicated in the table here after.

(F11)

	Cable gland and dimensions		Maximum cable diameter allowed [mm]
<b>BN 63</b>	2 x M20 x 1.5	1 Hole on each side	13
<b>BN 71</b>	2 x M25 x 1.5		17
<b>BX 80 - BX 90</b> <b>BE 80 - BE 90</b> <b>BN 80 - BN 90</b>	2 x M25 x 1.5		17
<b>BX 100 - BX 112</b> <b>BE 100 - BE 112</b> <b>BN 100 - BN 112</b>	2 x M32 x 1.5	2 Holes on each side	21
	2 x M25 x 1.5		17
<b>BX 132 - BE 132</b> <b>BN 132...BN 160MR</b>	4 x M32 x 1.5		
<b>BX 160 - BX 180</b> <b>BE 160 - BE 180</b> <b>BN 160M...BN 200L</b>	2 x M40 x 1.5	Pivoting, 4 x 90°	28

## 5.9 Bearings

Life lubricated preloaded radial ball bearings are used, types are shown in the chart here under. Calculated endurance lifetime  $L_{10h}$ , as per ISO 281, in unloaded condition, exceeds 40000 hrs.

**DE** = drive end

**NDE** = non drive end

(F12)

	<b>DE</b>	<b>NDE</b>	
	<b>BX, BE, BN, BN_FD, BN_FA</b>	<b>BX, BE, BN</b>	<b>BN_FD, BN_FA</b>
<b>BN 56</b>	6201 2Z C3	6201 2Z C3	–
<b>BN 63</b>	6201 2Z C3	6201 2Z C3	6201 2RS C3
<b>BN 71</b>	6202 2Z C3	6202 2Z C3	6202 2RS C3
<b>BX 80 - BE 80</b> <b>BN 80</b>	6204 2Z C3	6204 2Z C3	6204 2RS C3
<b>BX 90 - BE 90</b> <b>BN 90</b>	6205 2Z C3	6205 2Z C3	6305 2RS C3
<b>BX 100 - BE 100</b> <b>BN 100</b>	6206 2Z C3	6206 2Z C3	6206 2RS C3
<b>BX 112 - BE 112</b> <b>BN 112</b>	6306 2Z C3	6306 2Z C3	6306 2RS C3
<b>BX 132 - BE 132</b> <b>BN 132</b>	6308 2Z C3	6308 2Z C3	6308 2RS C3
<b>BN 160MR</b>	6309 2Z C3	6308 2Z C3	6308 2RS C3
<b>BX 160M/L</b> <b>BE 160M/L</b> <b>BN 160M/L</b>	6309 2Z C3	6309 2Z C3	6309 2RS C3
<b>BN 180M</b>	6310 2Z C3	6309 2Z C3	6309 2RS C3
<b>BX 180M/L</b> <b>BE 180M/L</b> <b>BN 180L</b>	6310 2Z C3	6310 2Z C3	6310 2RS C3
<b>BN 200L</b>	6312 2Z C3	6310 2Z C3	6310 2RS C3



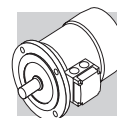

## 6 ELECTRICAL CHARACTERISTICS

### 6.1 Voltage

Single speed motors are provided in standard execution either for nominal voltage 230 / 400 V  $\Delta/Y$ , 50 Hz, or 400 / 690 V  $\Delta/Y$ , 50 Hz, with a voltage tolerance of  $\pm 10\%$ , according to what is specified on the below table.

On all the motors BN, for which the voltage / frequency configuration is not included on the below table, the voltage tolerance is reduced down to  $\pm 5\%$ .

For the operation out of the tolerance boundaries, the temperature may exceed by 10 K the limit provided by the adopted insulation class.

The motors are suitable for operation on distribution European grid with voltage complying with the publication IEC 60038.

(F13)

Efficiency class		$V_{mot}$ $\pm 10\%$ 3 ~	Configuration
IE3	BX 80 ... 132	230 / 400 V - $\Delta/Y$ - 50 Hz	standard
	BX 160, BX 180	400 / 690 V - $\Delta/Y$ - 50 Hz	standard
IE2	BE 80 ... 132	230 / 400 V - $\Delta/Y$ - 50 Hz	standard
		460 V Y - 60 Hz <sup>1</sup>	standard
		400 / 690 V - $\Delta/Y$ - 50 Hz	At request, carries no extra charge
	BE 160, BE 180	400 / 690 V - $\Delta/Y$ - 50 Hz	standard
		460 V $\Delta$ - 60 Hz <sup>1</sup>	standard
IE1	BN 56 ... BN 132	230 / 400 V - $\Delta/Y$ - 50 Hz	standard
		400 / 690 V - $\Delta/Y$ - 50 Hz	At request, carries no extra charge
		460 V Y - 60 Hz	standard
	BN 160 ... 200	400 / 690 V - $\Delta/Y$ - 50 Hz	standard
		460 V $\Delta$ - 60 Hz	standard

<sup>1</sup> 4 pole motor only

The only rated voltage for motors type at 50 Hz and all double speed motors is 400 V. Applicable tolerances as per CEI EN 60034-1.

The table below shows the wiring options available.

(F14)

Number of poles		Winding connection
2	BE 80 ... BE 160 - BN 63 ... BN 200	$\Delta / Y$ <sup>(2)</sup>
4	BX 80 ... BX 180 BE 80 ... BE 180 - BN 56 ... BN 200	
6	BE 90 ... BE 160 - BN 63 ... BN 200	
8	BN 71 ... BN 132	
2/4	BN 63 ... BN 132	$\Delta / YY$ (Dahlander)
2/6	BN 71 ... BN 132	Y / Y (Two windings)
2/8	BN 71 ... BN 132	
2/12	BN 80 ... BN 132	
4/6	BN 71 ... BN 132	
4/8	BN 80 ... BN 132	$\Delta / YY$ (Dahlander)

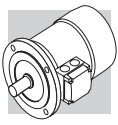

<sup>(2)</sup> Motors with voltage in ratio 2 (ex. 230/460 - 60) will be equipped with a 9 pin terminal box with winding connection either  $\Delta\Delta / \Delta$  or  $YY / Y$  (except 6 pole BN 63  $\Delta / Y$ )



## 6.2 Frequency

Rated output power BN for 60 Hz operation is shown in the following diagram.

(F15)

	P <sub>n</sub> [kW]					P <sub>n</sub> [kW]			
	2P	4P	6P	8P		2P	4P	6P	8P
<b>BN 56A</b>	–	0.07	–	–	<b>BN 100L</b>	3.5	–	–	–
<b>BN 56B</b>	–	0.10	–	–	<b>BN 100LA</b>	–	2.5	1.8	0.85
<b>BN 63A</b>	0.21	0.14	0.10	–	<b>BN 100LB</b>	4.7	3.5	2.2	1.3
<b>BN 63B</b>	0.30	0.21	0.14	–	<b>BN 112M</b>	4.7	4.7	2.5	1.8
<b>BN 63C</b>	0.45	0.30	–	–	<b>BN 132S</b>	–	6.5	3.5	2.5
<b>BN 71A</b>	0.45	0.30	0.21	0.10	<b>BN 132SA</b>	6.5	–	–	–
<b>BN 71B</b>	0.65	0.45	0.30	0.14	<b>BN 132SB</b>	8.7	–	–	–
<b>BN 71C</b>	0.90	0.65	0.45	–	<b>BN 132M</b>	11	–	–	3.5
<b>BN 80A</b>	0.90	0.65	0.45	0.21	<b>BN 132MA</b>	–	8.7	4.6	–
<b>BN 80B</b>	1.30	0.90	0.65	0.30	<b>BN 132MB</b>	–	11	6.5	–
<b>BN 80C</b>	1.80	1.3	0.90	–	<b>BN 160MR</b>	12.5	12.5	–	–
<b>BN 90S</b>	–	1.3	0.90	0.45	<b>BN 160MB</b>	17.5	–	–	–
<b>BN 90SA</b>	1.8	–	–	–	<b>BN 160M</b>	–	–	8.6	–
<b>BN 90SB</b>	2.2	–	–	–	<b>BN 160L</b>	21.5	17.5	12.6	–
<b>BN 90L</b>	2.5	–	1.3	0.65	<b>BN 180M</b>	24.5	21.5	–	–
<b>BN 90LA</b>	–	1.8	–	–	<b>BN 180L</b>	–	25.3	17.5	–
<b>BN 90LB</b>	–	2.2	–	–	<b>BN 200L</b>	–	34	–	–
					<b>BN 200LA</b>	34	–	22	–

BX and BE motors are available at 60 Hz on a 4 pole configuration only, and their power rating is the same as their 50 Hz counterpart. Double speed BN motors supplied at 60 Hz will have an increase of nominal power, referred to 50 Hz, equal to 15%, whereas double speed BX / BE motors are not available. If a nominal power rating, equal to the normalised nominal power rating at 50 Hz, was requested to be on a nameplate of a motor meant to be voltage supplied at 60 Hz, the PN option shall be specified on the motor designation.

Motors normally designed for a 50 Hz frequency may be used on a 60 Hz operating grid, but the related data shall be updated according to the following table.

Motors designated for 50 Hz operation show on the nameplate also the values for 60 Hz operation (excluding motors in CUS execution and brake motors). See the following table.

(F16)

	50 Hz		60 Hz		
	V - 50 Hz	V - 60 Hz	P <sub>n</sub> - 60 Hz	M <sub>n</sub> , M <sub>a</sub> /M <sub>n</sub> - 60 Hz	n [min <sup>-1</sup> ] - 60 Hz
<b>BX/BE</b>	<b>230/400 Δ/Y</b>	265 - 460 Δ Y	1	0.83	1.2
	<b>400/690 Δ/Y</b>	460 Δ			
<b>BN</b>	<b>230/400 Δ/Y</b>	220 - 240 Δ			
		380 - 415 Y			
	<b>400/690 Δ/Y</b>	380 - 415 Δ			
<b>BN</b>	<b>230/400 Δ/Y</b>	265 - 280 Δ			
		440 - 480 Y			
	<b>400/690 Δ/Y</b>	440 - 480 Δ			

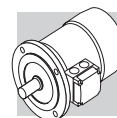

### 6.3 Ambient temperature

Catalogue rating values are calculated for 50 Hz operation and for standard ambient conditions (temperature 40 °C; elevation ≤ 1000 m a.s.l.) as per the CEI EN 60034-1 Standards.

The motors can be used within the 40 - 60 °C temperature range with rated power output adjusted by factors given in the table below.

(F17)

Ambient temperature (°C)	40°	45°	50°	55°	60°
Permitted power as a % of rated power	100%	95%	90%	85%	80%

Should a derating factor higher than 15% apply please consult factory.

### 6.4 50 HZ normalized power

**PN**

With this option, motor name plate includes 50 Hz normalized power information even when motor is designated for operation with 60 Hz power mains. For 60 Hz supplies along with voltages 230/460V and 575V the PN option is applied by default.

### 6.5 Motors for USA and Canada

**CUS**

Motors are available in NEMA Design C configuration (concerning electrical characteristics), in compliance with CSA (Canadian standard) C22.2 No. 100 and UL (Underwriters Laboratory) UL 1004-1. By specifying the option CUS the name plate is marked with both symbols shown here below.



CUS option is not currently available for IE3 motors.

The CUS option does not apply to servo-ventilated motors.

US power mains voltages and the corresponding rated voltages to be specified for the motor are indicated in the following table:

(F18)

Frequency	Mains voltage	V <sub>mot</sub>
60 Hz	208 V	<b>200 V</b>
	240 V	<b>230 V</b>
	480 V	<b>460 V</b>
	600 V	<b>575 V</b>

CUS option is applicable onto 50 Hz operating motors as well.

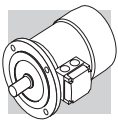

Motors with voltage in ratio 2 (e.g. 230/460-60; 220/440-60) feature, as standard, a 9-stud terminal board. For some executions, as well as for 575V-60Hz supply, the nominal rating is coincident with the correspondent 50Hz rating.

For DC brake motors type BN\_FD, the rectifier is connected to a single-phase 230 VAC supply voltage in the motor terminal box.

Brake power supply for brake motors is as follows:

(F19)

BN_FD	BN_FA		Power supply
Connected to terminal box 1~230V c.a.	Separate power supply	230V Δ	230SA
	Separate power supply	460V Y	460SA

## 6.6 China Compulsory Certification

**CCC**

Electric motors destined for sale in the People's Republic of China have to be certified under the CCC (China Compulsory Certification) system. BN motors of up to 7 Nm in rated torque are available with CCC certification and a special nameplate bearing the mark shown below:



CCC option is not currently available for IE3 motors.

CCC option is not currently available for servo - ventilated motors.

## 6.7 Insulation class

**CL F**

Bonfiglioli motors use class **F** insulating materials (enamelled wire, insulators, impregnation resins) as compare to the standard motor.

In standard motors, stator windings over temperature normally stays below the 80 K limit corresponding to class B over temperature.

A careful selection of insulating components makes the motors compatible with tropical climates and normal vibration.

For applications involving the presence of aggressive chemicals or high humidity, contact Bonfiglioli Engineering for assistance with product selection.

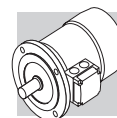

# CL H

Motors manufactured in insulation class **H** are available at request.  
 Not available for motors in compliance with CSA e UL standards (CUS option).

(F20)

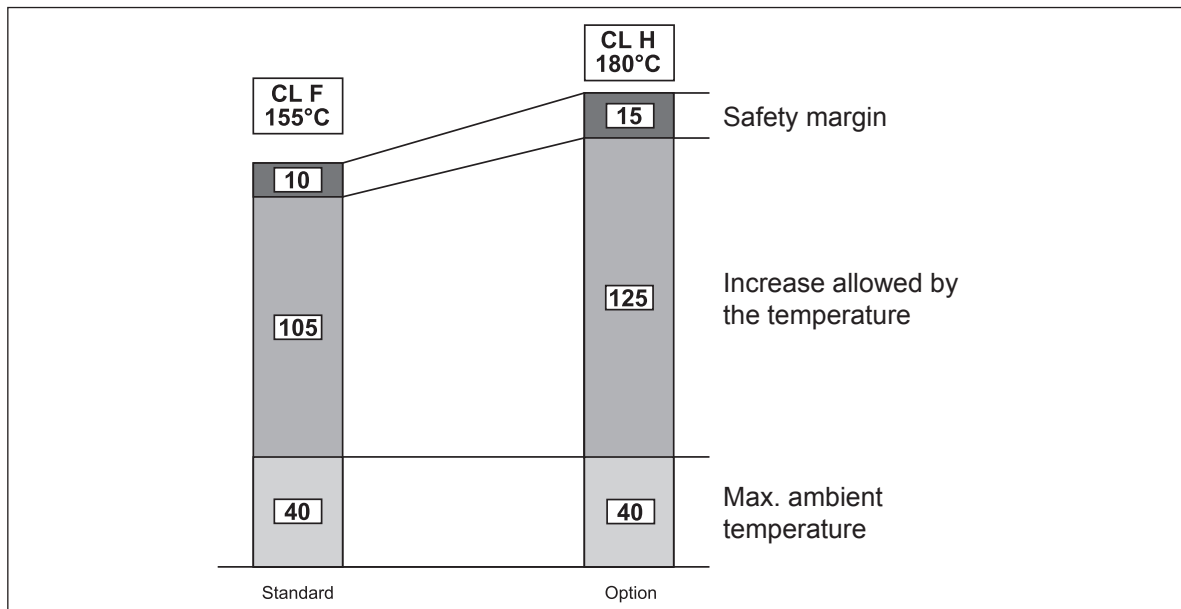

## 6.8 Type of duty

Unless otherwise specified, catalogue motor power refers to continuous duty S1.

Any operating conditions other than S1 duty must be identified in accordance with duty cycle definitions laid down in standards CEI EN 60034-1.

For duty cycles S2 and S3, the power increase coefficient reported in the following table may be used. Please note that the table provided below applies to single-speed motors.

As an alternative to S1 continuous duty, one of the following values can be specified at the product configuration stage: S2, S3 or S9. The motor nameplate will be marked with an increased power rating to suit the type of duty, and with specific electrical data and a duty type of S2-30 min, S3-70% or S9 respectively.

For further details, contact Bonfiglioli's Technical Service.

Please contact Bonfiglioli Engineering for the power increase coefficients applicable to switch-pole motors.

(F21)

	Type of duty						S4 - S9 Contact us
	S2			S3 *			
	Duration (min)			Intermittence (I)			
	10	30 (*)	60	25%	40%	70% (*)	
$f_m$	1.35	1.15	1.05	1.25	1.15	1.1	

\* Cycle duration must, in any event, be equal to or less than 10 minutes; if this time is exceeded, please contact our Technical Service.

(\*) Default values from options (tab. F05).

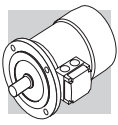

### 6.8.1 Cyclic duration factor:

$$I = \frac{t_f}{t_f + t_r} \cdot 100 \quad (01)$$

$t_f$  = work time under constant load

$t_r$  = rest time

### 6.8.2 Limited duration duty S2

This type of duty is characterized by operation at constant load for a limited time, which is shorter than the time required to reach thermal equilibrium, followed by a rest period of sufficient duration to restore ambient temperature in the motor.

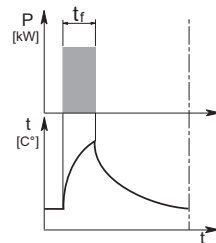

### 6.8.3 Periodical intermittent duty S3:

This type of duty is characterized by a sequence of identical operation cycles, each including a constant load operation period and a rest period.

For this type of duty, the starting current does not significantly influence overtemperature.

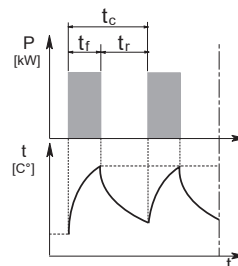

## 6.9 Inverter-controlled motors

The electric motors Bonfiglioli may be used in combination with PWM inverters with rated voltage at transformer input up to 500 V. Standard motors use a phase insulating system with separators, class 2 enamelled wire and class H impregnation resins (1600V peak-to-peak voltage pulse capacity and rise edge  $t_s > 0.1\mu s$  at motor terminals). Typical torque/speed curves referred to S1 duty for motors with base frequency  $f_b = 50$  Hz is are reported in the table below.

Because ventilation is somewhat impaired in operation at lower frequencies (about 30 Hz), standard motors with incorporated fan (IC411) require adequate torque derating or - alternately - the addition of a separate supply fan cooling.

Above base frequency, upon reaching the maximum output voltage of the inverter, the motor enters a steady-power field of operation, and shaft torque drops with ratio  $(f/f_b)$ . As motor maximum torque decreases with  $(f/f_b)^2$ , the allowed overloading must be reduced progressively.

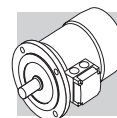

(F22)

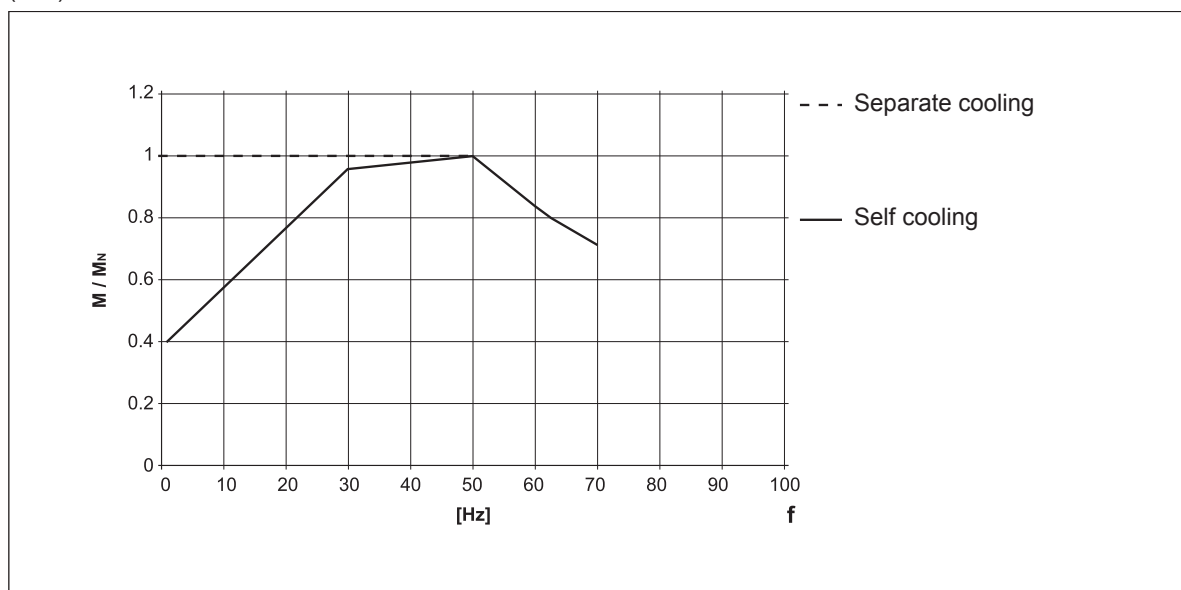

The following table reports the mechanical speed limit for motors operating above rated frequency:

(F23)

	n [min <sup>-1</sup> ]		
	2p	4p	6p
≤ BE 112 - BN 112	5200	4000	3000
≥ BE 132 - BN 132	4500	4000	3000
BX 80 ... BX 180		4000	

Above rated speed, motors generate increased mechanical vibration and fan noise. Class B rotor balancing is highly recommended in these applications. Installing a separate supply fan cooling may also be advisable.

Remote-controlled fan and brake (if fitted) must always be connected direct to mains power supply.

## 6.10 Permissible starts per hour, Z

The rating charts of brakemotors lend the permitted number of starts  $Z_0$ , based on 50% intermittence and for unloaded operation.

The catalogue value represents the maximum number of starts per hour for the motor without exceeding the rated temperature for the insulation class F.

To give a practical example for an application characterized by inertia  $J_c$ , drawing power  $P_r$  and requiring mean torque at start-up  $M_L$  the actual number of starts per hour for the motor can be calculated approximately through the following equation:

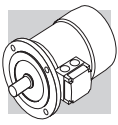

$$Z = \frac{Z_0 \cdot K_c \cdot K_d}{K_J} \quad (02)$$

where:

$$K_J = \frac{J_m + J_c}{J_m} \quad \text{inertia factor}$$

$$K_c = \frac{M_a - M_L}{M_a} \quad \text{torque factor}$$

$$K_d = \quad \text{load factor, see the following table}$$

(F24)

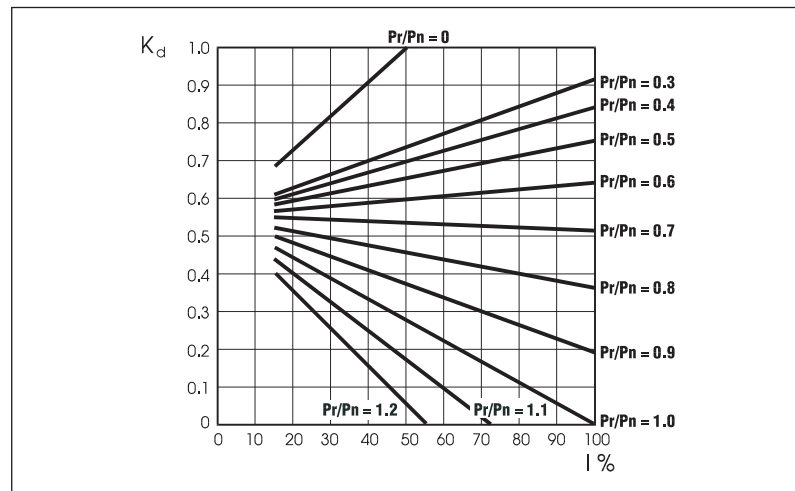

If actual starts per hour is within permitted value (Z) it may be worth checking that braking work is compatible with brake (thermal) capacity Wmax also given in the tables (F31), (F39) and dependent on the number of switches (c/h).



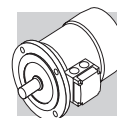

## 7 ASYNCHRONOUS BRAKE MOTORS

### 7.1 Operation

Versions with incorporated brake use spring-applied DC (FD option) or AC (FA options) brakes. All brakes are designed to provide fail-safe operation, meaning that they are applied by spring-action in the event of power failure.

(F25)

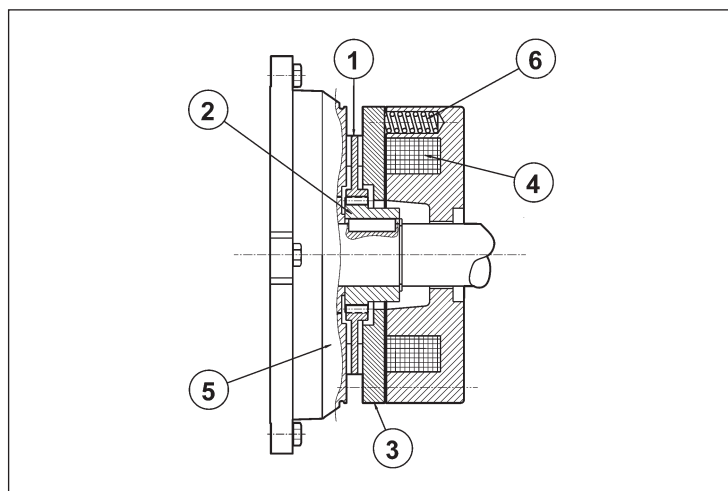

Key:

- ① brake disc
- ② disc carrier
- ③ pressure plate
- ④ brake coil
- ⑤ motor rear shield
- ⑥ brake springs

When voltage is interrupted, pressure springs push the armature plate against the brake disc. The disc becomes trapped between the armature plate and motor shield and stops the shaft from rotation. When the coil is energized, a magnetic field strong enough to overcome spring action attracts the armature plate, so that the brake disc – which is integral with the motor shaft – is released.

### 7.2 Most significant features

- High braking torques (normally  $M_b \approx 2 M_n$ ), braking torque adjustment.
- Steel brake disc with double friction lining (low-wear, asbestos-free lining).
- Hexagonal seat on motor shaft fan end (N.D.E.) for manual rotation (not compatible with options PS, RC, TC, U1, U2, EN1, EN2, EN3, EN4, EN5, EN6).
- Manual release lever (options **R** and **RM** for BN\_FD; option **R** for BN\_FA).
- Corrosion-proof treatment on all brake surfaces.
- Insulation class F.

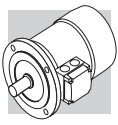

## 8 DC BRAKE MOTORS TYPE BN\_FD

Frame sizes: BN 63 ... BN 200L

BE motors may be available equipped with the FD brake, for further information please contact our Technical Department.

(F26)

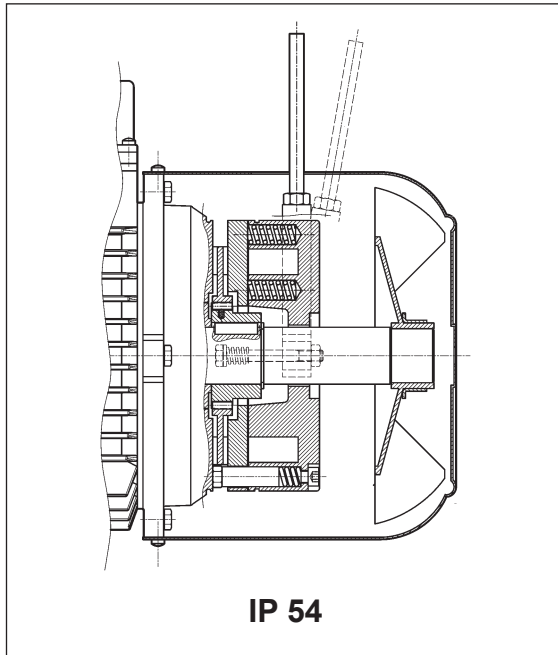

(F27)

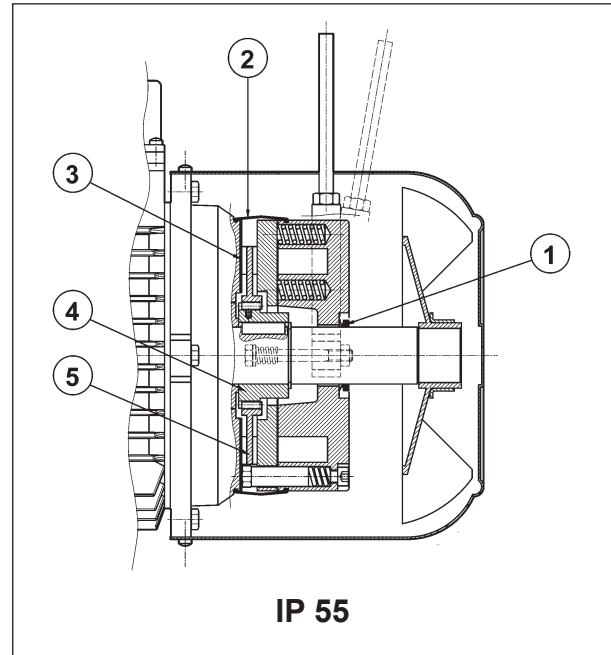

**Direct current** toroidal-coil electromagnetic brake bolted onto motor shield. Preloading springs provide axial positioning of magnet body.

Brake disc slides axially on steel hub shrunk onto motor shaft with anti-vibration device.

Brake torque factory setting is indicated in the corresponding motor rating charts. Braking torque may be modified by changing the type and/or number of springs.

At request, motors may be equipped with manual release lever with automatic return (**R**) or system for holding brake in the released position (**RM**).

See variant at paragraph "BRAKE RELEASE SYSTEMS" for available release lever locations.

FD brakes ensure excellent dynamic performance with low noise. DC brake operating characteristics may be optimized to meet application requirements by choosing from the various rectifier/power supply and wiring connection options available.

**For applications involving lifting and/or high hourly energy dissipation, contact Bonfiglioli's Technical Service.**

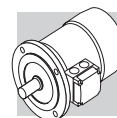

## 8.1 Degree of protection

Standard protection class is IP54.

Brake motor FD is also available in protection class **IP55**, which mandates the following variants:

- ① V-ring at N.D.E. of motor shaft
- ② dust and water-proof rubber boot
- ③ stainless steel ring placed between motor shield and brake disc
- ④ stainless steel hub
- ⑤ stainless steel brake disc

## 8.2 FD brake power supply

A rectifier accommodated inside the terminal box feeds the DC brake coil. Wiring connection across rectifier and brake coil is performed at the factory.

On all single-pole motors, rectifier is connected to the motor terminal board.

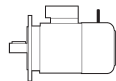

Rectifier standard power supply voltage  $V_B$  is as indicated in the following table, regardless of mains frequency:

(F28)

2, 4, 6 P				1 speed
	<b>BN_FD</b> $V_{mot} \pm 10\%$ 3 ~		$V_B \pm 10\%$ 1 ~	brake connected to terminal board power supply separate power supply
<b>BN 63...BN 132</b>	230/400 V – 50 Hz	230 V	standard	specificare $V_B$ SA o $V_B$ SD
<b>BN 160...BN 200</b>	400/690 V – 50 Hz	400 V	standard	specificare $V_B$ SA o $V_B$ SD

Switch-pole motors feature a separate power supply line for the brake with rectifier input voltage  $V_B$  as indicated in the table below:

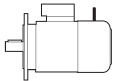

(F29)

2/4, 2/6, 2/8, 2/12, 4/6, 4/8 P				2 speed
	<b>BN_FD</b> $V_{mot} \pm 10\%$ 3 ~		$V_B \pm 10\%$ 1 ~	brake connected to terminal board power supply separate power supply
<b>BN 63...BN 132</b>	400 V – 50 Hz	230 V		specify $V_B$ SA o $V_B$ SD

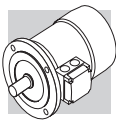
The diode half-wave rectifier ( $V_{DC} \approx 0,45 \times V_{AC}$ ) is available in versions **NB**, **SB**, **NBR** e **SBR**, as detailed in the table below:

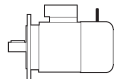

(F30)

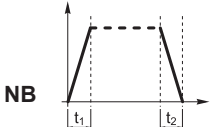
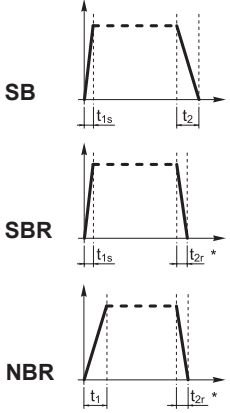
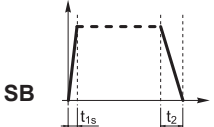
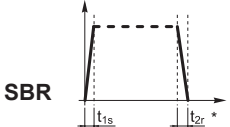
	brake		
		standard	at request
<b>BN 63</b>	<b>FD 02</b>		
<b>BN 71</b>	<b>FD 03</b> <b>FD 53</b>		
<b>BN 80</b>	<b>FD 04</b>		
<b>BN 90S</b>	<b>FD 14</b>		
<b>BN 90L</b>	<b>FD 05</b>		
<b>BN 100</b>	<b>FD 15</b>		
<b>BN 112</b>	<b>FD 06S</b>		
<b>BN 132 - BN 160MR</b>	<b>FD 56</b>		
	<b>FD 06</b> <b>FD 07</b>		
<b>BN 160L - BN 180M</b>	<b>FD 08</b>		
<b>BN 180L - BN 200M</b>	<b>FD 09</b>		

(\*)  $t_{2c} < t_{2r} < t_2$

Rectifier **SB** with electronic energizing control over-energizes the electromagnet upon power-up to cut brake release response time and then switches to normal half-wave operation once the brake has been released.

Use of the **SB** rectifier is mandatory in the event of:

- high number of operations per hour
- reduced brake release response time
- brake is exposed to extreme thermal stress

Rectifiers **NBR** or **SBR** are available for applications requiring quick brake intervention (braking condition reinstatement) response.

These rectifiers complement the **NB** and **SB** types as their electronic circuit incorporates a static switch that de-energizes the brake quickly in the event voltage is missing.

This arrangement ensures short brake release response time with no need for additional external wiring and contacts.

Optimum performance of rectifiers **NBR** and **SBR** is achieved with separate brake power supply.

**Versions available: 230Vac ±10%, 400Vac ± 10%, 50/60 Hz (with power supply); 100Vdc ±10%, 180Vdc ± 10% (with SD option).**

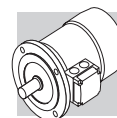

### 8.3 FD brake technical specifications

The table below reports the technical specifications of DC brakes FD.

(F31)

Brake	Brake torque $M_b$ [Nm]			Release		Braking		$W_{max}$ per brake operation			W [MJ]	P [W]
	springs			$t_1$	$t_{1s}$	$t_2$	$t_{2c}$	[ J ]				
	6	4	2	[ms]	[ms]	[ms]	[ms]	10 s/h	100 s/h	1000 s/h		
FD02	–	3.5	1.75	30	15	80	9	4500	1400	180	15	17
FD03	5	3.5	1.75	50	20	100	12	7000	1900	230	25	24
FD53	7.5	5	2.5	60	30	100	12					
FD04	15	10	5	80	35	140	15	10000	3100	350	30	33
FD14												
FD05	40	26	13	130	65	170	20	18000	4500	500	50	45
FD15	40	26	13	130	65	170	20					
FD06S	60	40	20	–	80	220	25	20000	4800	550	70	55
FD56	–	75	37	–	90	250	20	29000	7400	800	80	65
FD06		100	50		100	250	20					
FD07	150	100	50	–	120	200	25	40000	9300	1000	130	65
FD08*	250	200	170	–	140	350	30	60000	14000	1500	230	100
FD09**	400	300	200	–	200	450	40	70000	15000	1700	230	120

\* brake torque values obtained with 9, 7 and 6 springs, respectively

\*\* brake torque values obtained with 12, 9 and 6 springs, respectively

$t_1$  = brake release time with half-wave rectifier  
 $t_{1s}$  = brake release time with over-energizing rectifier  
 $t_2$  = brake engagement time with AC line interruption and separate power supply  
 $t_{2c}$  = brake engagement time with AC and DC line interruption – Values for  $t_1$ ,  $t_{1s}$ ,  $t_2$ ,  $t_{2c}$  indicated in the tab. (F30) are referred to brake set at maximum torque, medium air gap and rated voltage  
 $W_{max}$  = max energy per brake operation  
W = braking energy between two successive air gap adjustments  
 $P_b$  = brake power absorption at 20 °C  
 $M_b$  = static braking torque ( $\pm 15\%$ )  
s/h = starts per hour

The brake pad wear depends on the operating/ambient conditions (temperature, humidity, angular speed, specific pressure); Therefore the declared wear rate must be considered as indicative.

### 8.4 FD brake connections

On standard single-pole motors, the rectifier is connected to the motor terminal board at the factory. For switch-pole motors and where a separate brake power supply is required, connection to rectifier must comply with brake voltage VB stated in motor name plate.

**Because the load is of the inductive type, brake control and DC line interruption must use contacts from the usage class AC-3 to IEC 60947-4-1.**

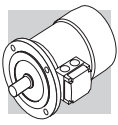

Table (F32) – Brake power supply from motor terminals and AC line interruption

Delayed stop time  $t_2$  and function of motor time constants.

Mandatory when soft-start/stops are required.

Table (F33) – Brake coil with separate power supply and AC line interruption

Normal stop time independent of motor.

Achieved stop times  $t_2$  are indicated in the table (F31).

Table (F34) – Brake coil power supply from motor terminals and AC/DC line interruption.

Quick stop with operation times  $t_{2c}$  as per table (F31).

Table (F35) – Brake coil with separate power supply and AC/DC line interruption.

Stop time decreases by values  $t_{2c}$  indicated in the table (F31).

The brake may be voltage supplied directly from the motor terminal box (from tab. F32 to tab. F35) only if the nominal voltage of the brake is the same as the smaller voltage of the motor.

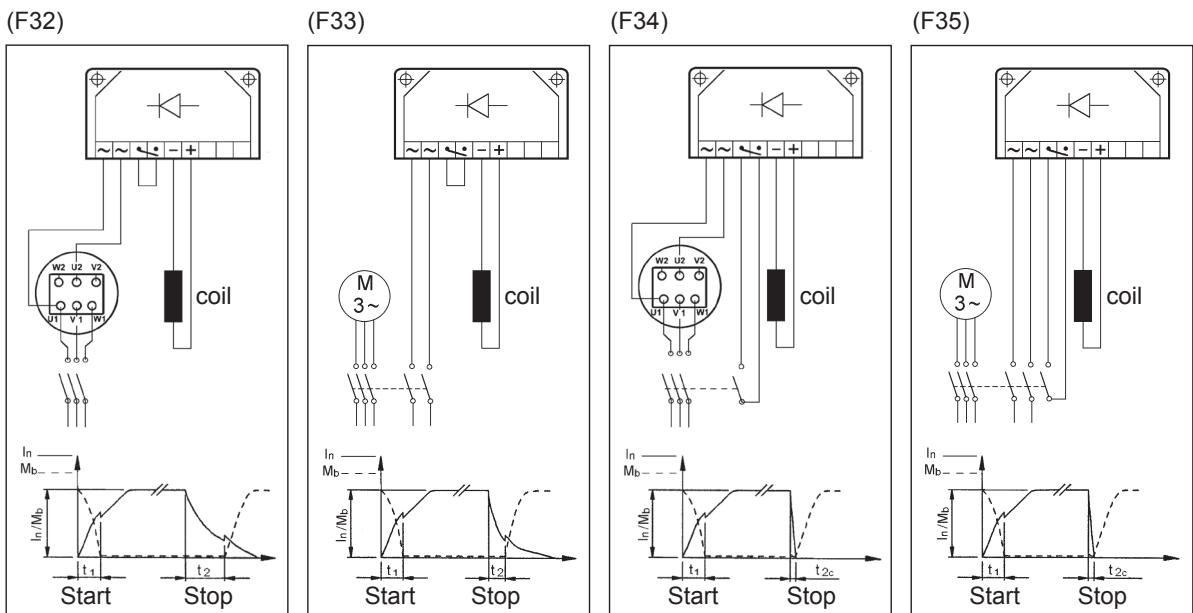

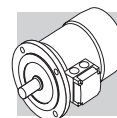

## 9 AC BRAKE MOTORS TYPE BN\_FA

Frame sizes: BN 63 ... BN 180M

(F36)

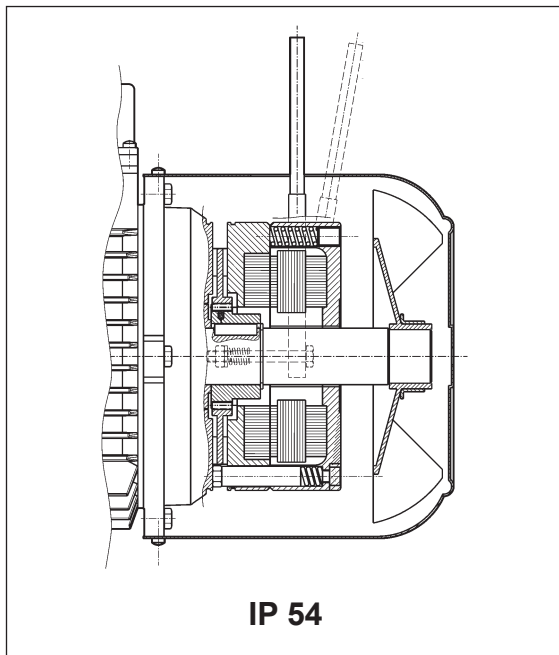

(F37)

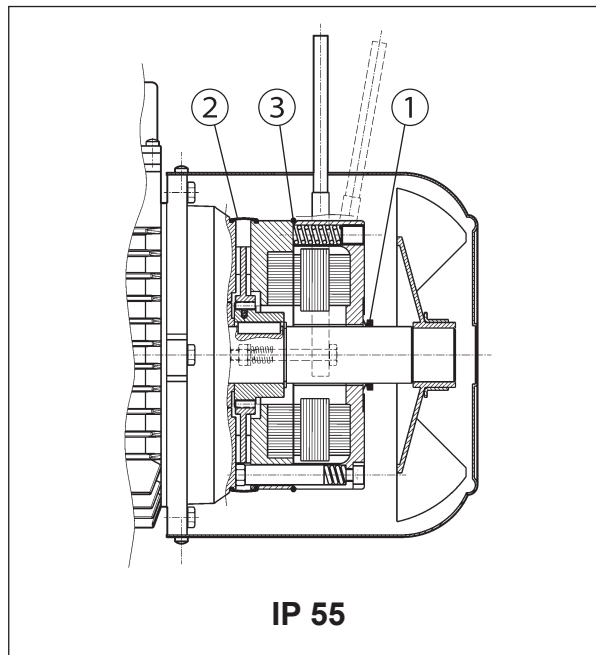

Electromagnetic brake operates from three-phase alternated current power supply and is bolted onto conveyor shield. Preloading springs provide axial positioning of magnet body. Steel brake disc slides axially on steel hub shrunk onto motor shaft with anti-vibration device. Brake torque factory setting is indicated in the corresponding motor rating charts. Spring preloading screws provide stepless braking torque adjustment. Torque adjustment range is  $30\% M_{bMAX} < M_b < M_{bMAX}$  (where  $M_{bMAX}$  is maximum braking torque as shown in tab. (F39)). Thanks to their high dynamic characteristics, FA brakes are ideal for heavy-duty applications as well as applications requiring frequent stop/starts and very fast response time. Motors may be equipped with manual release lever with automatic return (R) at request. See variant at paragraph "BRAKE RELEASE SYSTEMS" for available release lever locations. **For applications involving lifting and/or high hourly energy dissipation, contact Bonfiglioli's Technical Service.**

### 9.1 Degree of protection

Standard protection class is IP54.

Brake motor FA is also available in protection class **IP55**, which mandates the following variants:

- ① V-ring at N.D.E. of motor shaft
- ② dust and water-proof rubber boot
- ③ O-ring

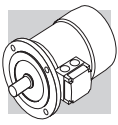

## 9.2 FA brake power supply

In single speed motors, power supply is brought to the brake coil direct from the motor terminal box. As a result, brake voltage and motor voltage are the same. In this case, brake voltage indication may be omitted in the designation. Switch-pole motors and motors with separate brake power supply feature an auxiliary terminal board with 6 terminals for connection to brake line. In both cases, brake voltage indication in the designation is mandatory. The following table reports standard AC brake power supply ratings for single- and switch-pole motors:

(F38)

<b>single-pole motor</b>	<b>BN 63...BN 132</b>	<b>BN 160...BN 180</b>
	230Δ / 400Y V ±10% – 50 Hz	400Δ/ 690Y V ±10% – 50 Hz
	265Δ / 460Y ±10% - 60 Hz	460Y – 60 Hz
<b>switch-pole motors</b> (separate power supply line)	<b>BN 63...BN 132</b>	
	230Δ / 400Y V ±10% – 50 Hz	
	460Y - 60 Hz	

Unless otherwise specified, standard brake power supply is 230Δ /400Y V - 50 Hz.

Special voltages in the 24...690 V, 50-60 Hz range are available at request.

## 9.3 Technical specifications of FA brakes

(F39)

Brake	Brake torque $M_b$ [Nm]	Release $t_1$ [ms]	Braking $t_2$ [ms]	$W_{max}$ [ J ]			W [MJ]	P [VA]
				10 s/h	100 s/h	1000 s/h		
FA 02	3.5	4	20	4500	1400	180	15	60
FA 03	7.5	4	40	7000	1900	230	25	80
FA 04	15	6	60	10000	3100	350	30	110
FA 14								
FA 05	40	8	90	18000	4500	500	50	250
FA 15								
FA 06S	60	16	120	20000	4800	550	70	470
FA 06	75	16	140	29000	7400	800	80	550
FA 07	150	16	180	40000	9300	1000	130	600
FA 08	250	20	200	60000	14000	1500	230	1200

$M_b$  = max static braking torque (±15%)  
 $t_1$  = brake release time  
 $t_2$  = brake engagement time  
 $W_{max}$  = max energy per brake operation (brake thermal capacity)  
W = braking energy between two successive air gap adjustments  
 $P_b$  = power drawn by brake at 20° (50 Hz)  
s/h = starts per hour

**NOTE**  
Values  $t_1$  and  $t_2$  in the table refer to a brake set at rated torque, medium air gap and rated voltage.



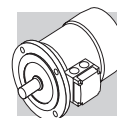

The brake pad wear depends on the operating/ambient conditions (temperature, humidity, angular speed, specific pressure); Therefore the declared wear rate must be considered as indicative.

#### 9.4 FA brake connections

The diagram below shows the wiring when brake is connected directly to same power supply of the motor:

(F40)

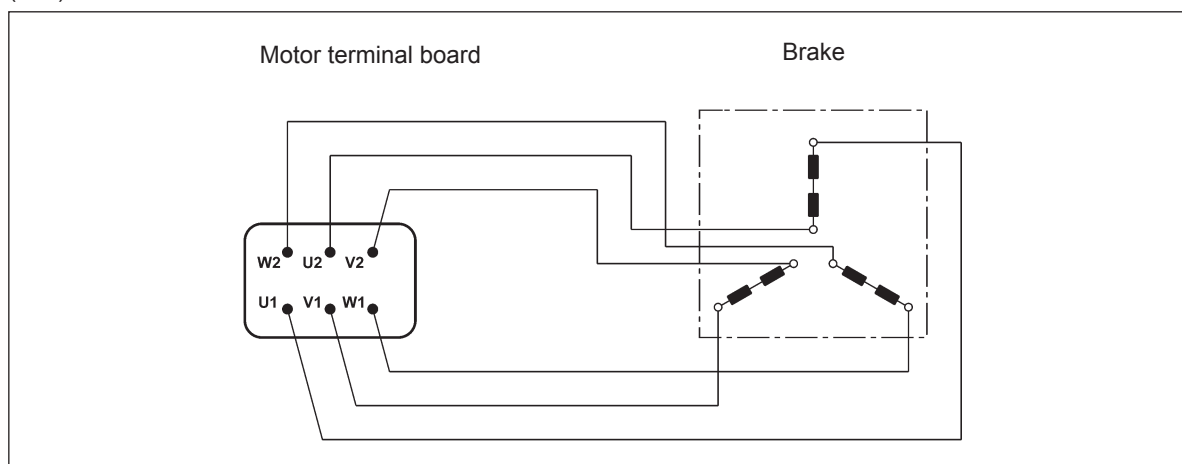

Switch-pole motors and, at request, single-pole motors with separate power supply are equipped with an auxiliary terminal board with 6 terminals for brake connection.

In this version, motors feature a larger terminal box. See diagram below:

(F41)

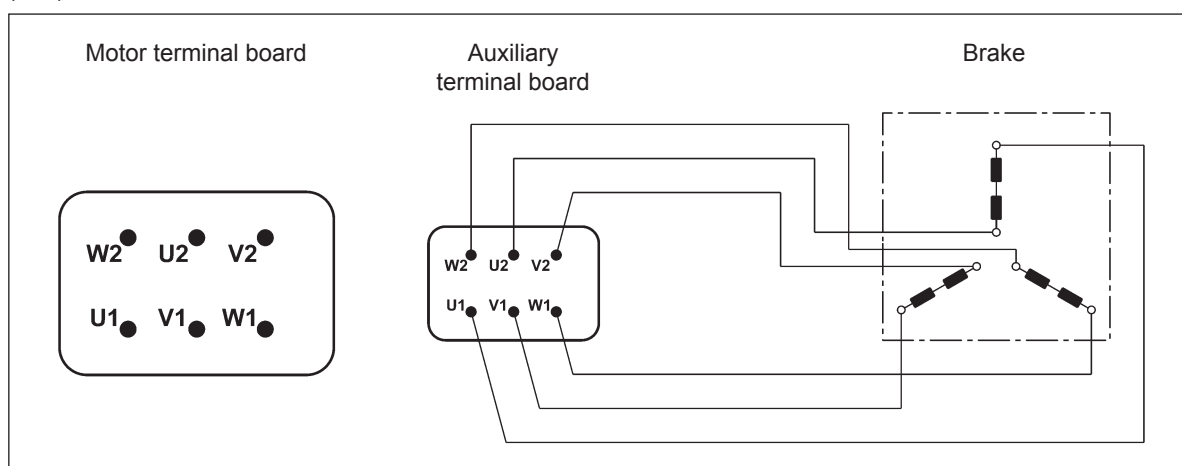

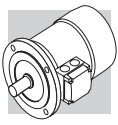

## 10 BRAKE RELEASE SYSTEMS

Spring-applied brakes type FD and FA may be equipped with optional manual release devices. These are typically used for manually releasing the brake before servicing any machine or plant parts operated by the motor.

**R**

(F42)

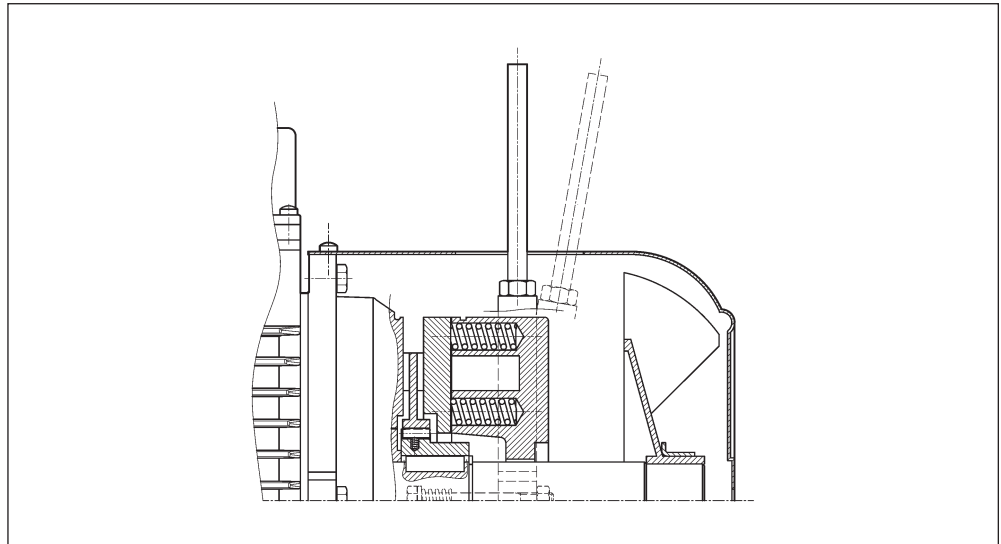

A return spring brings the release lever back in the original position.

**RM**

(F43)

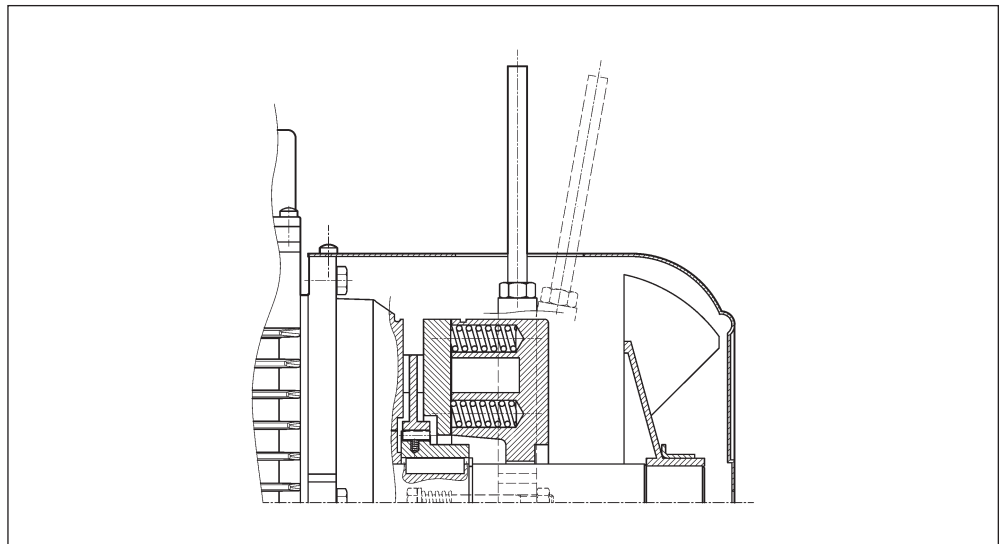

On motors type BN\_FD, if the option RM is specified, the release device may be locked in the "release" position by tightening the lever until its end becomes engaged with a brake housing projection. The availability for the various disengagement devices is charted here below:

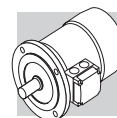

(F44)

	R	RM
BN_FD	BN 63...BN 200	BN 63 ... BN 132 FD07
BN_FA	BN 63...BN 180M	

### 10.1 Release lever orientation

Unless otherwise specified, the release lever is located 90° away from the terminal box – identified by letters **[AB]** in the diagram below – in a clockwise direction on both options **R** and **RM**. Alternative lever positions **[AA]**, **[AC]** and **[AD]** are also possible when the corresponding option is specified:

(F45)

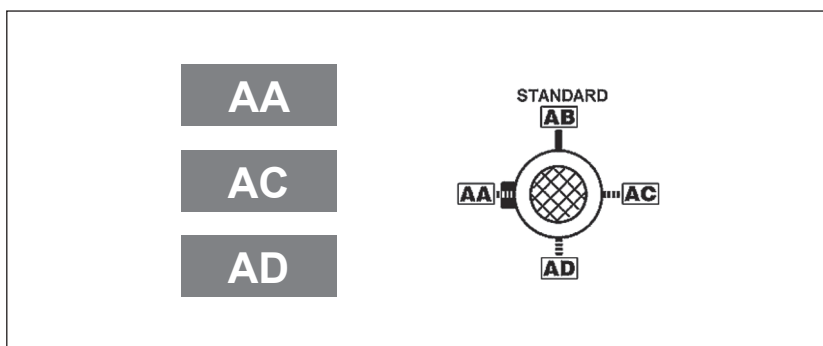

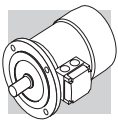

## 11 OPTIONS

### 11.1 Soft-start / stop

#### F1

An optional flywheel - option F1 - is available for applications requiring soft starting or stopping. The flywheel's added inertia uses up kinetic energy during starting and returns it back during braking, thus catering for more progressive and gradual shock loads. The optional flywheel is available for brake motors type BN\_FD with specific characteristics as detailed in the table below:

(F46)

Main data for flywheel of motore type: BN_FD, M_FD		
	Fly-wheel weight [Kg]	Fly-wheel inertia [Kgm <sup>2</sup> ]
<b>BN 63</b>	0.69	0.00063
<b>BN 71</b>	1.13	0.00135
<b>BN 80</b>	1.67	0.00270
<b>BN 90S - BN 90L</b>	2.51	0.00530
<b>BN 100</b>	3.48	0.00840
<b>BN 112</b>	4.82	0.01483
<b>BN 132S - BN 132M</b>	6.19	0.02580

### 11.2 Capacitive filter

#### CF

An optional capacitive filter is available for DC brake motors type BN\_FD only. When the suitable capacitive filter is installed upstream of the rectifier (option CF), motors comply with the emission limits required by standard EN61000-6-3:2007“ Electromagnetic Compatibility – Generic Emission Standard – Part 6-3: Residential, commercial and light industrial environment”.

### 11.3 Thermal protective devices

In addition to the standard protection provided by the magneto-thermal device, motors can be supplied with built-in thermal probes to protect the winding against overheating caused, by insufficient ventilation or by an intermittent duty.

This additional protection should always be specified for servo-ventilated motors (IC416).

### 11.4 Thermistors

#### E3

These are semi-conductors having rapid resistance variation when they are close to the rated switch off temperature (150 °C).

Variations of the  $R = f(T)$  characteristic are specified under DIN 44081, IEC 34-11 Standards.

Positive temperature coefficient thermistors are normally used (also known as PTC “cold conductor resistors”). Thermistors cannot control relays directly and must be connected to a suitable disconnect device. Thus protected, three PTCs connected in series are installed in the winding, the terminals of which are located on the auxiliary terminal-board.

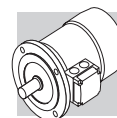

## K1

The design characteristics of this sub-group of PTC thermistors allow them to be used as positive temperature coefficient sensors with variable resistance.

Functioning temperature range: 0°C ... +260°C.

Thermistors cannot control relays directly and must be connected to a suitable disconnect device.

Terminals (polarised) for 1 x KTY 84-130 are provided on an auxiliary terminal strip.

### 11.5 Bimetallic thermostates

## D3

These types of protective devices house a bimetal disk. When the rated switch off temperature (150 °C) is reached, the disk switches the contacts from their initial rest position.

As temperature falls, the disk and the contacts automatically return to rest position.

Three bimetallic thermostates connected in series are usually employed, with normally closed contacts. The terminals are located on an auxiliary terminal-board.

### 11.6 Plug connector

## CON

Three types of connectors (CON 1, CON 2, CON 3) are provided; they can be mounted in two different positions: right side of terminal box cover (C1D, C2D, C3D); left side of terminal box cover (C1S, C2S, C3S).

The option CON is applicable to single speed BN motors (2, 4, 6, 8 poles), and BX / BE motors on the sizes specified on the following table. All double speed motors are excluded.

The connectors CON 1 / CON 2 are available for BX, BE and BN motors without brake and for BN brakemotors equipped with DC brake type FD, for the motor sizes listed below.

**The male connector (with pins) is mounted on the motor, the female connector is not provided. With CON option, the winding connection is always Y.**

With option U1 “forced ventilation”, the fan unit supply is available inside the separate terminal box fixed to fan cover.

With options EN1...EN6, the encoder connection is made by a cable not connected to the motor plug connector.

The CON option is not applicable to brakemotors equipped with AC brake type FA.

The CON option is not available when at least one of the next options are selected: the U2, CUS, IC.

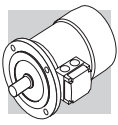

## Specifications

(F47)

Option	<b>CON 1</b>
Motor size	<b>BX 80 ... BX 112 / BE 80 ... BE 112 / BN 63 ... BN 112</b>
Connector view	
Type of connector	Harting Han 10ES
Housing	Han EMC 10B with 2 levers
Numbers of pins - nominal current	10 x 16A
Voltage	500 Vac
Contact connection	Screw terminals

(F48)

Option	<b>CON 2</b>
Motor size	<b>BX 80 ... BX 132 / BE 80 ... BE 132M / BN 63 ... BN 132M</b>
Connector view	
Type of connector	Harting Han Modular
Housing	Han EMC 10B with 2 levers
Module type	Module C + Module E + Module E
Numbers of pins - nominal current	3 x 36A / 6 x 16A
Voltage	500 Vac
Contact connection	Crimping contacts

(F49)

Option	<b>CON 3</b>
Motor size	<b>BN 63 ... BN 132M</b>
Connector view	
Type of connector	Harting Han Modular
Housing	Han EMC 10B with 2 levers
Module type	Module C + Module E + Module E
Numbers of pins - nominal current	3 x 36A / 6 + 6 x 16A
Voltage	500 Vac
Contact connection	Crimping contacts

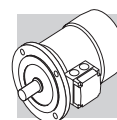

(F50)

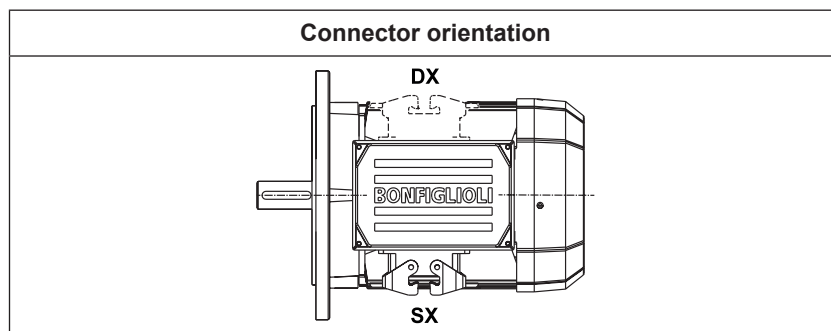

(F51)

**Motors without brake dimensions**

	AD (mm)	AF (mm)	AH (mm)	LL (mm)	V (mm)
<b>BN 63</b>	136	110	45	165	4.5
<b>BN 71</b>	149	110	45	165	15.5
<b>BX 80 - BE 80 - BN 80</b>	160	110	45	165	16.5
<b>BX 90 - BE 90 - BN 90</b>	162	110	45	165	31.5
<b>BX 100 - BE 100 - BN 100</b>	171	110	45	165	37.5
<b>BX 112 - BE 112 - BN 112</b>	186	110	45	165	39
<b>BX 132 - BE 132 - BN 132</b>	210	140	45	188	45.5
<b>BN 160MR</b>	210	140	45	188	161

(F52)

**Motors with FD brake dimensions**

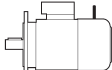
	AD (mm)	AF (mm)	AH (mm)	LL (mm)	V (mm)
<b>BN 63</b>	136	110	45	165	4.5
<b>BN 71</b>	149	110	45	165	1.5
<b>BN 80</b>	160	110	45	165	18.5
<b>BN 90</b>	162	110	45	165	39.5
<b>BN 100</b>	171	110	45	165	63.5
<b>BN 112</b>	186	110	45	165	75
<b>BN 132</b>	210	140	45	188	122
<b>BN 160MR</b>	210	140	45	188	161

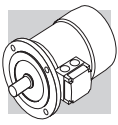

## 11.7 Control of brake operation

### MSW

The microswitch can be set in order to obtain from it a signal related to the attraction/release of an anchor plate, or it can be set in order to give feedback when the air gap reaches the maximum value.

**MSW option is available for brakes FD03...FD09.**

The microswitch is provided with three lead wires (NC, NO, COM). The next figure shown the main components of the brake equipped with microswitch.

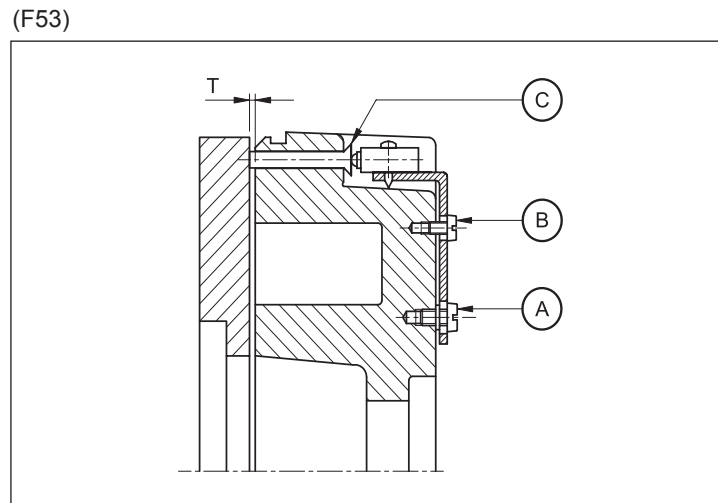

- A: Plate fixing screws
- B: Setting screws
- C: Actuator control pin

## 11.8 Additional cable entry for brakemotors

### IC

The terminal box cover of brakemotors BN63...BN160MR is provided with two additional cable entry M16 x 1.5 (one cable entry per side).

The terminal box cover of brakemotors BN160...BN200 is provided with an additional cable entry M16 x 1.5 next to the cable entry used for the brake.

## 11.9 Anti-condensation heaters

### H1

### NH1

Where an application involves high humidity or extreme temperature fluctuation, motors may be equipped with an anti-condensate heater.

A single-phase power supply is available in the auxiliary terminal board inside the main terminal box. Values for the absorbed power are listed here below:



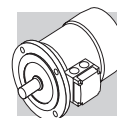

(F54)

	H1	NH1
	1~ 230V ± 10% P [W]	1~ 115V ± 10% P [W]
BX 80 BE 80 BN 56 ... BN 80	10	10
BX 90 ... BX 132 BE 90 ... BE 132MB BN 90 ... BN 160MR	25	25
BX 160, BX 180 BE 160, BE 180 BN 160, BN 200	50	50

**Warning!**

Always remove power supply to the anti-condensante heater before operating the motor.

**11.10 Tropicalization**

**TP**

When option **TP** is specified, motor windings receive additional protection for operation in high humidity and temperature conditions.

**11.11 Second shaft extension**

**PS**

This option is not compatible with variants RC, TC, U1, U2, EN1, EN2, EN3, EN4, EN5, EN6. For shaft dimensions please see motor dimensions tables.

(F55)

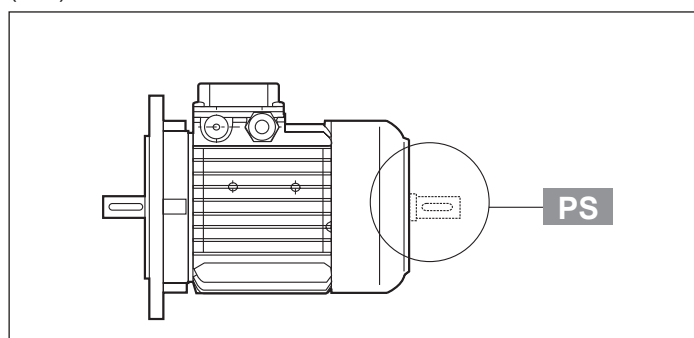

**11.12 Rotor balancing**

**RV**

Where low noise is a priority requirement, the option RV ensures reduced vibration in accordance with vibration class B.

The table below reports effective velocity of vibration for normal (A) and B grade balancing.

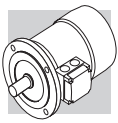

(F56)

Vibration level	Angular velocity	Limits of the vibration velocity
	$n$ [ $\text{min}^{-1}$ ]	(mm/s) <b>BX 80 ≤ H ≤ BX 180L</b> <b>BE 80 ≤ H ≤ BE 180L</b> <b>BN 56 ≤ H ≤ BN 200</b>
<b>A</b>	$600 < n < 3600$	1.6
<b>B</b>	$600 < n < 3600$	0.70

Values are obtained from measurements on freely suspended motor during noload operation; tolerance  $\pm 10\%$ .

### 11.13 Ventilation

Motors are cooled through outer air blow (IC 411 according to CEI EN 60034-6) and are equipped with a plastic radial fan, which operates in both directions.

Ensure that fan cover is installed at a suitable distance from the closest wall so to allow air circulation and servicing of motor and brake, if fitted.

On request, motors can be supplied with independently power-supplied forced ventilation system starting from BN 71, BE 80 and BX 80 size.

Motor is cooled by an axial fan with independent power supply and fitted on the fan cover (IC 416 cooling system).

This version is used in case of motor driven by inverter so that steady torque operation is possible even at low speed or when high starting frequencies are needed.

Brake motors of motors with rear shaft projection (PS option) are excluded.

This variant has two different models, called **U1** and **U2**, having the same longitudinal size. Longer side of fan cover (**DL**) is specified for both models in the table below. Overall dimension can be reckoned from motor size table.

(F57)

Extra length for servoventilated motors		
	$\Delta L_1$	$\Delta L_2$
<b>BN 71</b>	93	32
<b>BX 80 - BE 80 - BN 80</b>	127	55
<b>BX 90 - BE 90 - BN 90</b>	131	48
<b>BX 100 - BE 100 - BN 100</b>	119	28
<b>BX 112 - BE 112 - BN 112</b>	130	31
<b>BX 132 - BE 132 - BN 132</b>	161	51
<b>BX 160 - BE 160 - BE 180</b>	184	—

$\Delta L_1$  = extra length to LB value of corresponding standard motor.

$\Delta L_2$  = extra length to LB value of corresponding brake motor.  
Only for BN motors.

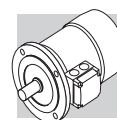

## U1

Fan wiring terminals are housed in a separate terminal box.

In brake motors of size BX 132 ... BX 160 - BE 80 ... BE 160 - BN 71 ... BN 160MR, with **U1** model, the release lever cannot be positioned to AA.

The option is not applicable to motors compliant with the CSA and UL norms (option CUS).

(58)

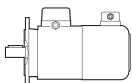
	V a.c. ±10%	Hz	P [W]	I [A]
<b>BN 71</b>	1 ~ 230	50 / 60	22	0.12
<b>BX 80 - BE 80</b> <b>BN 80</b>			22	0.12
<b>BX 90 - BE 90</b> <b>BN 90</b>			40	0.30
<b>BX 100 - BE 100</b> <b>BN 100</b>			50	0.25
<b>BX 112 - BE 112</b> <b>BN 112</b>	3 ~ 230Δ / 400Y	50	50	0.26 / 0.15
<b>BX 132 - BE 132</b> <b>BN 132 ... BN 160MR</b>			110	0.38 / 0.22
<b>BX 160 - BE 160</b> <b>BN 160M ... BN 180M</b>			180	1.25 / 0.72
<b>BX 180 - BE 180</b> <b>BN 180L ... BN 200L</b>			250	1.51 / 0.87

## U2

Fan terminals are wired in the motor terminal box.

The **U2** option does not apply to motors BX/BE and to motors with option CUS (compliant to norms CSA and UL).

(59)

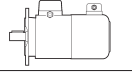
	V a.c. ±10%	Hz	P [W]	I [A]
<b>BN 71</b>	1 ~ 230	50 / 60	22	0.12
<b>BN 80</b>			22	0.12
<b>BN 90</b>			40	0.30
<b>BN 100</b>			40	0.26 / 0.09
<b>BN 112</b>	3 ~ 230Δ / 400Y	50	50	0.26 / 0.15
<b>BN 132 ... BN 160MR</b>			110	0.38 / 0.22

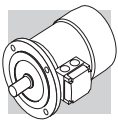

### 11.14 Rain canopy

#### RC

The rain canopy protects the motor from dripping and avoids the ingress of solid bodies. It is recommended when motor is installed in a vertical position with the shaft downwards.

Relevant dimensions are indicated in the table below.

The drip cover is not compatible with variants PS, EN1, EN2, EN3, EN4, EN5, EN6.

(60)

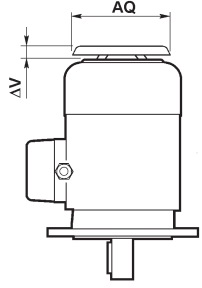
	AQ	$\Delta V$	
<b>BN 63</b>	118	24	
<b>BN 71</b>	134	27	
<b>BX 80 - BE 80</b> <b>BN 80</b>	152	25	
<b>BX 90 - BE 90</b> <b>BN 90</b>	168	30	
<b>BX 100 - BE 100</b> <b>BN 100</b>	190	28	
<b>BX 112 - BE 112</b> <b>BN 112</b>	211	32	
<b>BX 132 - BE 132</b> <b>BN 132...BN 160MR</b>	254	32	
<b>BX 160 - BE 160</b> <b>BN 160M...BN 180M</b>	302	36	
<b>BX 180 - BE 180</b> <b>BN 180L...BN 200L</b>	340	36	

### 11.15 Textile canopy

#### TC

Option TC is a cover variant for textile industry environments, where lint may obstruct the fan grid and prevent a regular flow of cooling air.

This option is not compatible with variants EN1, EN2, EN3, EN4, EN5, EN.

Overall dimensions are the same as drip cover type RC.

### 11.16 Feedback units

Motors may be combined with six different types of encoders to achieve feedback circuits.

Configurations with double-extended shaft (PS) and rain canopy (RC, TC) are not compatible with encoder installation.

#### EN1

Incremental encoder,  $V_{IN} = 5 V$ , line-driver output RS 422.

#### EN2

Incremental encoder,  $V_{IN} = 10-30 V$ , line-driver output RS 422.

#### EN3

Incremental encoder,  $V_{IN} = 12-30 V$ , push-pull output 12-30 V

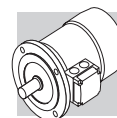

## EN4

Encoder sin/cos,  $V_{IN} = 4.5-5.5$  V, output Sinus  $0.5V_{PP}$ .

## EN5

Absolute encoder singleturn, HIPERFACE® interface,  $V_{IN} = 7-12$  V.

## EN6

Absolute encoder multiturn, HIPERFACE® interface,  $V_{IN} = 7-12$  V.

(F61)

	EN1	EN2	EN3	EN4	EN5	EN6
Interface	TTL/RS 422	TTL/RS 422	HTL/push-pull	Sinus 0.5 VPP	HIPERFACE®	HIPERFACE®
Power supply voltage [V]	4...6	10...30	12...30	4.4...5.5	7...12	7...12
Output voltage [V]	5	5	12...30	—	—	—
No-load operating current [mA]	120	100	100	40	80	80
No. of pulses per revolution	1024					
Steps per revolution	—	—	—	—	15 bit	15 bit
Revolutions	—	—	—	—	—	12 bit
No. of signals	6 (A, B, Z + inverted signals)			6 (cos-, cos+, sin-, sin+, Z, Z)	—	—
Max. output frequency [kHz]	600			200		
Max. speed [ $\text{min}^{-1}$ ]	6000 (9000 $\text{min}^{-1}$ for 10 s)					
Temperature range [ $^{\circ}\text{C}$ ]	-30 ... +100					
Protection class	IP 65					

(F62)

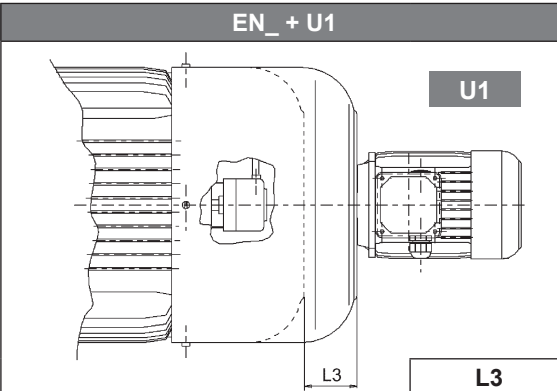
EN_ + U1	
	<b>L3</b>
BX 160 - BE 160 - BN 160M...BN 180M	72
BX 160 - BE 180 - BN 180L...BN 200L	82
BN 160M_FD...BN 180M_FD	35
BN 180L_FD...BN 200L_FD	41

(F63)

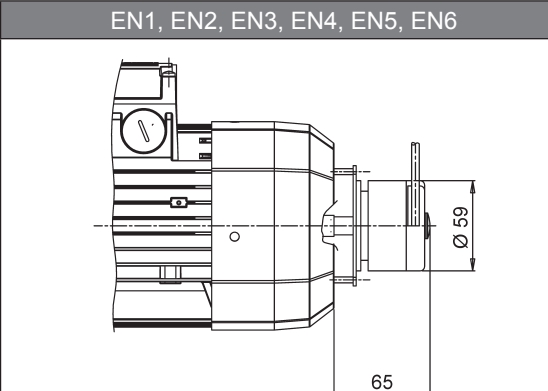
EN1, EN2, EN3, EN4, EN5, EN6	
	$\varnothing 59$ 65
BX 80 ... BX 180L - BE 80 ... BE 180L	
BN 63 ... BN 200L	
BN 63_FD ... BN 200L_FD	
BN 63_FA ... BN 200L_FA	

If the encoder device (option EN\_) is specified on motors BX 80 ... BX 132 - BE 80 ... BE132 - BN 71 ... BN 160MR, along with the independent fan cooling (options U1, U2), the extra length of motor is coincident with that of the correspondent U1 and U2 execution.

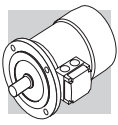

### 11.17 Surface protection

#### C\_

When no specific protection class is requested, the painted (ferrous) surfaces of motors are protected to at least corrosivity class C2 (UNI EN ISO 12944-2). For improved resistance to atmospheric corrosion, motors can be delivered with C3 and C4 surface protection.

(F64)

<b>SURFACE PROTECTION</b>	Typical environments	Maximum surface temperature	Corrosivity class according to UNI EN ISO 12944-2
<b>C3</b>	Urban and industrial environments with up to 100% relative humidity (medium air pollution)	120°C	C3
<b>C4</b>	Industrial areas, coastal areas, chemical plant, with up to 100% relative humidity (high air pollution)	120°C	C4

Motors with optional protection to class C3 or C4 are available in a choice of colours. If no specific colour is requested (see the “PAINTING” option) motors are finished in RAL 7042.

Motors can also be supplied with surface protection for corrosivity class C5 according to UNI EN ISO 12944-2. Contact our Technical Service for further details.

### 11.18 Painting

#### RAL

Gearboxes with optional protection to class C3 or C4 are available in the colours listed in the following table.

(F65)

<b>PAINTING</b>	Colour	RAL number
<b>RAL7042*</b>	Traffic Grey A	7042
<b>RAL5010</b>	Gentian Blue	5010
<b>RAL9005</b>	Jet Black	9005
<b>RAL9006</b>	White Aluminium	9006
<b>RAL9010</b>	Pure White	9010

\* Gearboxes are supplied in this standard colour if no other colour is specified.

NOTE – “PAINTING” options can only be specified in conjunction with “SURFACE PROTECTION” options.

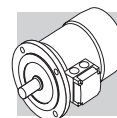

## 11.19 Certificates

### ACM

#### Certificate of compliance of motors

The document certifies the compliance of the product with the purchase order and the construction in conformity with the applicable procedures of the Bonfiglioli Quality System.

### CC

#### Inspection certificate

The document entails checking on order compliance, the visual inspection of external conditions and instrumental testing of the electrical characteristics in unloaded conditions. Units inspected are sampled within the shipping batch and marked individually.

## 12 TABLES OF MOTORS CORRELATION

(F66)

pole	2			
	IE1	IE2	IE3	
<b>Efficiency class</b>				
<b>0.06</b>				
<b>0.09</b>				
<b>0.12</b>				
<b>0.18</b>	BN 63A 2			
<b>0.25</b>	BN 63B 2			
<b>0.37</b>	BN 71A 2			
<b>0.55</b>	BN 71B 2			
<b>0.75</b>	BN 71C 2	BE 80A 2		
	BN 80A 2			
<b>1.1</b>	BN 80B 2	BE 80B 2		
<b>1.5</b>	BN 90SA 2	BE 90SA 2		
<b>1.85</b>	BN 90SB 2			
<b>Pn [kW]</b>	<b>2.2</b>	BN 90L 2	BE 90L 2	
	<b>3</b>	BN 100L 2	BE 100L 2	
	<b>4</b>	BN 112M 2	BE 112M 2	
	<b>5.5</b>	BN 132SA 2	BE 132SA 2	
	<b>7.5</b>	BN 132SB 2	BE 132SB 2	
	<b>9.2</b>	BN 132M 2	BE 132MB 2	
	<b>11</b>	BN 160MR 2	BE 160MA 2	
		BN 160M 2		
	<b>15</b>	BN 160MB 2	BE 160MB 2	
	<b>18.5</b>	BN 160L 2	BE 160L 2	
	<b>22</b>	BN 180M 2		
	<b>30</b>	BN 200LA 2		

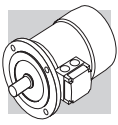

(F67)

pole		4		
Efficiency class		IE1	IE2	IE3
Pn [kW]	0.06	BN 56A 4		
	0.09	BN 56B 4		
	0.12	BN 63A 4		
	0.18	BN 63B 4		
	0.25	BN 63C 4		
		BN 71A 4		
	0.37	BN 71B 4		
	0.55	BN 71C 4		
		BN 80A 4		
	0.75	BN 80B 4	BE 80B 4	BX 80B 4
	1.1	BN 80C 4	BE 90S 4	BX 90S 4
		BN 90S 4		
	1.5	BN 90LA 4	BE 90LA 4	BX 90LA 4
	1.85	BN 90LB 4		
	2.2	BN 100LA 4	BE 100LA 4	BX 100LA 4
	3	BN 100LB 4	BE 100LB 4	BX 100LB 4
	4	BN 112M 4	BE 112M 4	BX 112M 4
	5.5	BN 132S 4	BE 132S 4	BX 132SB 4
	7.5	BN 132MA 4	BE 132MA 4	BX 132MA 4
	9.2	BN 132MB 4	BE 132MB 4	BX 160MA 4
11	BN 160MR 4	BE 160M 4	BX 160MB 4	
	BN 160M 4			
15	BN 160L 4	BE 160L 4	BX 160L 4	
18.5	BN 180M 4	BE 180M 4	BX 180M 4	
22	BN 180L 4	BE 180L 4	BX 180L 4	
30	BN 200L 4			



(F68)

pole		6		
Efficiency class		IE1	IE2	IE3
Pn [kW]	0.06			
	0.09	BN 63A 6		
	0.12	BN 63B 6		
	0.18	BN 71A 6		
	0.25	BN 71B 6		
		BN 71C 6		
	0.37	BN 80A 6		
	0.55	BN 80B 6		
	0.75	BN 80C 6	BE 90S 6	
		BN 90S 6		
	1.1	BN 90L 6	BE 100M 6	
	1.5	BN 100LA 6	BE 100LA 6	
	1.85	BN 100LB 6		
	2.2	BN 112M 6	BE 112M 6	
	3	BN 132S 6	BE 132S 6	
	4	BN 132MA 6	BE 132MA 6	
	5.5	BN 132MB 6	BE 160MA 6	
	7.5	BN 160M 6	BE 160MB 6	
	9.2			
	11	BN 160L 6		
15	BN 180L 6			
18.5	BN 200LA 6			
22				
30				

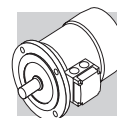



**13 MOTOR RATING CHARTS BX**

<b>4 P</b>		<b>1500 min<sup>-1</sup> - S1</b>											<b>50 Hz - IE3</b>		
<b>P<sub>n</sub></b> kW		<b>n</b> min <sup>-1</sup>	<b>M<sub>n</sub></b> Nm	<b>I<sub>n</sub></b> 400V A	<b>η%</b>			<b>cos φ</b>	$\frac{I_s}{I_n}$	$\frac{M_s}{M_n}$	$\frac{M_a}{M_n}$	<b>KVA</b> code	<b>J<sub>m</sub></b> x 10 <sup>-4</sup> kgm <sup>2</sup>	<b>IM B5</b> 	
					100%	75%	50%								
0.75	<b>BX 80B</b>	4	1425	5.0	1.61	82.5	83.9	83.2	0.81	6.5	2.0	1.8	J	35	16
1.1	<b>BX 90S</b>	4	1425	7.4	2.44	84.1	84.1	82.0	0.77	6.9	3.4	2.2	J	27	16
1.5	<b>BX 90LA</b>	4	1420	10.1	3.3	85.3	86.2	84.9	0.78	6.3	3.1	1.9	J	31	17
2.2	<b>BX 100LA</b>	4	1445	14.5	5.1	86.7	86.2	84.0	0.72	7.2	3.6	2.4	K	58	24
3	<b>BX 100LB</b>	4	1445	19.8	6.7	87.7	87.7	86.0	0.74	7.6	3.9	2.6	K	73	29
4	<b>BX 112M</b>	4	1445	26	8.1	88.6	88.9	87.6	0.8	8.1	3.8	2.5	J	130	38
5.5	<b>BX 132SB</b>	4	1460	36	10.6	89.6	89.2	88.8	0.83	8.2	3.6	2.3	J	310	57
7.5	<b>BX 132MA</b>	4	1460	49	15.0	90.4	90.9	90.2	0.80	8.4	3.8	2.5	K	360	67
9.2	<b>BX 160MA</b>	4	1465	60	17.8	91.0	92.1	91.7	0.82	7.9	3.6	2.1	J	650	95
11	<b>BX 160MB</b>	4	1465	72	20.5	91.4	92.9	92.5	0.84	7.8	3.4	1.9	J	780	110
15	<b>BX 160L</b>	4	1465	98	28.1	92.1	93.2	92.6	0.82	9.0	4.1	2.3	K	890	121
18.5	<b>BX 180M</b>	4	1480	119	32.9	92.6	94.1	93.1	0.85	11.3	2.6	2.3	M	1560	155
22	<b>BX 180L</b>	4	1475	142	38.2	93.0	93.6	92.8	0.88	10.2	2.5	2.0	L	1660	163

**BX**

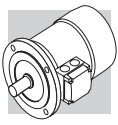

14 MOTORS DIMENSIONS BX

**BX - IM B3**

**BX**

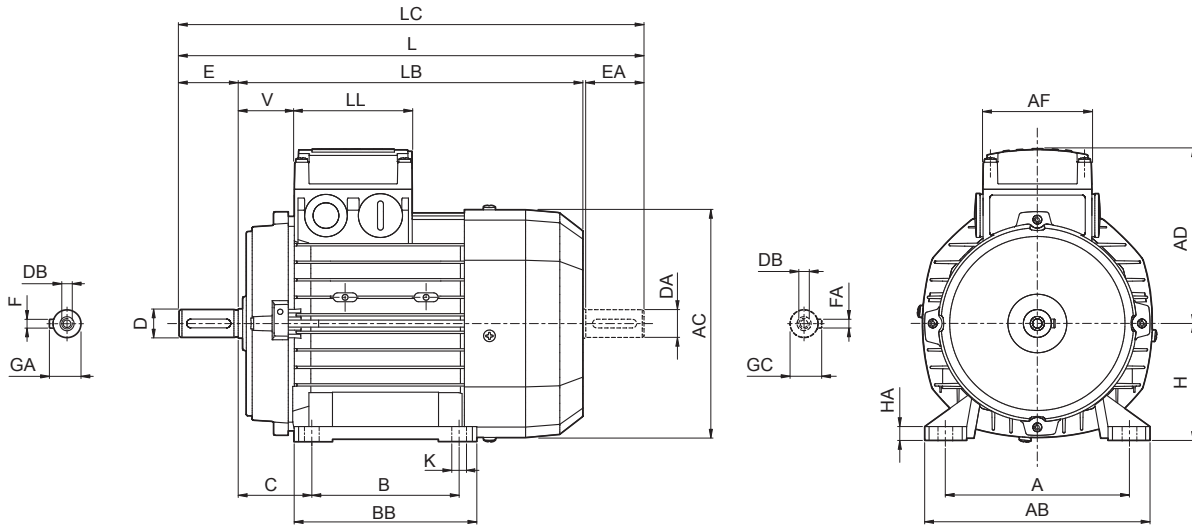

	Shaft					Housing						Motor									
	D DA	E EA	DB	GA GC	F FA	B	A	HA	BB	AB	K	C	H	AC	L	LB	LC	AD	AF	LL	V
<b>BX 80</b>	19 14 <sup>(1)</sup>	40 30 <sup>(1)</sup>	M6 M5 <sup>(1)</sup>	21,5 16 <sup>(1)</sup>	6 5 <sup>(1)</sup>	100	125	8	124	153	10	50	80	156	320	280	351	119	74	80	38
<b>BX 90 S</b>	24 19 <sup>(1)</sup>	50 40 <sup>(1)</sup>	M8 M6 <sup>(1)</sup>	27 21,5 <sup>(1)</sup>	8 6 <sup>(1)</sup>		140		155	174		12	56	90	176	326	276	368 378	133	98	98
<b>BX 90 L</b>						125															
<b>BX 100</b>	28 24 <sup>(1)</sup>	60 50 <sup>(1)</sup>	M10 M8 <sup>(1)</sup>	31 27 <sup>(1)</sup>	8 8 <sup>(1)</sup>	140	160	10	175	192	12	63	100	195	410	350	462	142	98	98	50
<b>BX 112</b>						190	224							70	112	219	430	370			482
<b>BX 132 SB</b>	38 28 <sup>(1)</sup>	80 60 <sup>(1)</sup>	M12 M10 <sup>(1)</sup>	41 31 <sup>(1)</sup>	10 8 <sup>(1)</sup>	140	216	12	218	254	12	89	132	258	493	413	556	193	118	118	58
<b>BX 132 MA</b>						178											528				448
<b>BX 160 MA</b>	42 38 <sup>(1)</sup>	110 80 <sup>(1)</sup>	M16 M12 <sup>(1)</sup>	45 41 <sup>(1)</sup>	12 10 <sup>(1)</sup>	210	254	25	264	319	14.5	108	160	310	596	486	680	245	187	187	51
<b>BX 160 MB</b>						254			304						640	530	724				
<b>BX 160 L</b>																					
<b>BX 180 M</b>	48 42 <sup>(1)</sup>	110 110 <sup>(1)</sup>	M16 M16 <sup>(1)</sup>	51.5 45 <sup>(1)</sup>	14 12 <sup>(1)</sup>	241	279	26	291	359	14	121	180	348	708	598	823	261			52
<b>BX 180 L</b>						279															

N.B.:

1) These values refer to the rear shaft end.

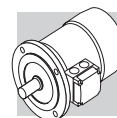

# BX - IM B5

**BX**

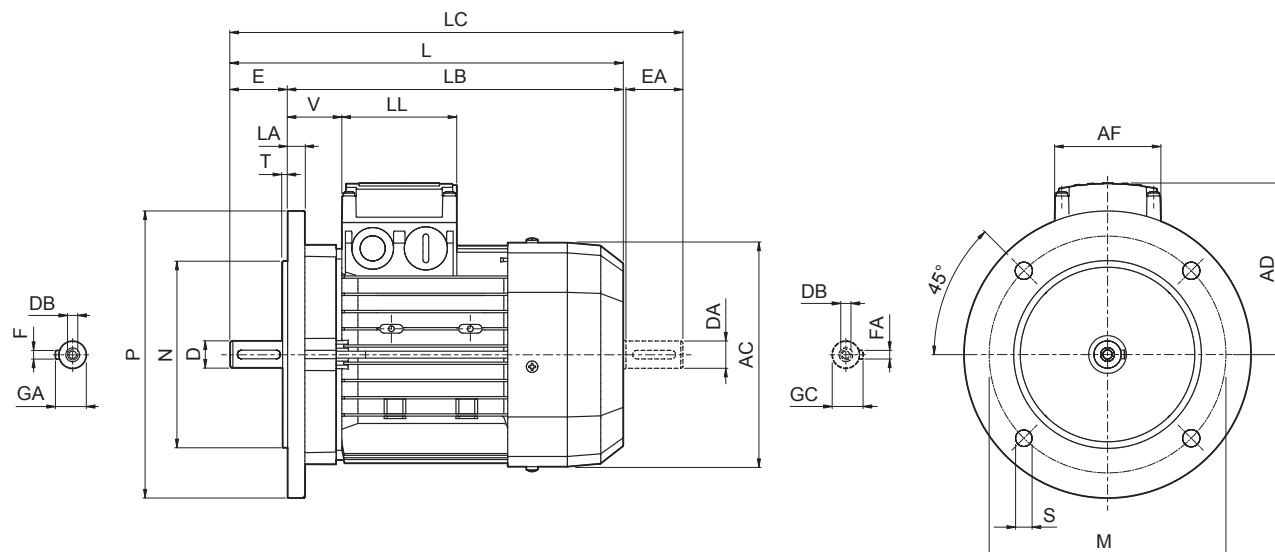

	Shaft					Flange					Motor											
	D DA	E EA	DB	GA GC	F FA	M	N	P	S	T	LA	AC	L	LB	LC	AD	AF	LL	V			
<b>BX 80</b>	19 14 <sup>(1)</sup>	40 30 <sup>(1)</sup>	M6 M5 <sup>(1)</sup>	21,5 16 <sup>(1)</sup>	6 5 <sup>(1)</sup>	165	130	200	11.5	3.5	11.5	156	320	280	351	119	74	80	38			
<b>BX 90</b>	24 19 <sup>(1)</sup>	50 40 <sup>(1)</sup>	M8 M6 <sup>(1)</sup>	27 21,5 <sup>(1)</sup>	8 6 <sup>(1)</sup>							176	326	276	368	133						
<b>BX 100</b>	28 24 <sup>(1)</sup>	60 50 <sup>(1)</sup>	M10 M8 <sup>(1)</sup>	31 27 <sup>(1)</sup>	8 8 <sup>(1)</sup>	215	180	250	14	4	14	195	410	350	462	142	98	98	50			
<b>BX 112</b>												15	219	430	370	482	157					
<b>BX 132 SB</b>	38 28 <sup>(1)</sup>	80 60 <sup>(1)</sup>	M12 M10 <sup>(1)</sup>	41 31 <sup>(1)</sup>	10 8 <sup>(1)</sup>	265	230	300	14	4	20	258	493	413	556	193	118	118	58			
<b>BX 132 MA</b>												528	448	591								
<b>BX 160 MA</b>	42 38 <sup>(1)</sup>	110 80 <sup>(1)</sup>	M16 M12 <sup>(1)</sup>	45 41 <sup>(1)</sup>	12 10 <sup>(1)</sup>	300	250	350	18.5	5	15	310	596	486	680	245	187	187	51			
<b>BX 160 MB</b>													640	530	724							
<b>BX 160 L</b>																						
<b>BX 180 M</b>	48 42 <sup>(1)</sup>	110 110 <sup>(1)</sup>	M16 M16 <sup>(1)</sup>	51.5 45 <sup>(1)</sup>	14 12 <sup>(1)</sup>	300	250	350	18.5	5	18	348	708	598	823	261				52		
<b>BX 180 L</b>																						

N.B.:  
1) These values refer to the rear shaft end.

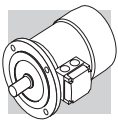

# BX - IM B14

**BX**

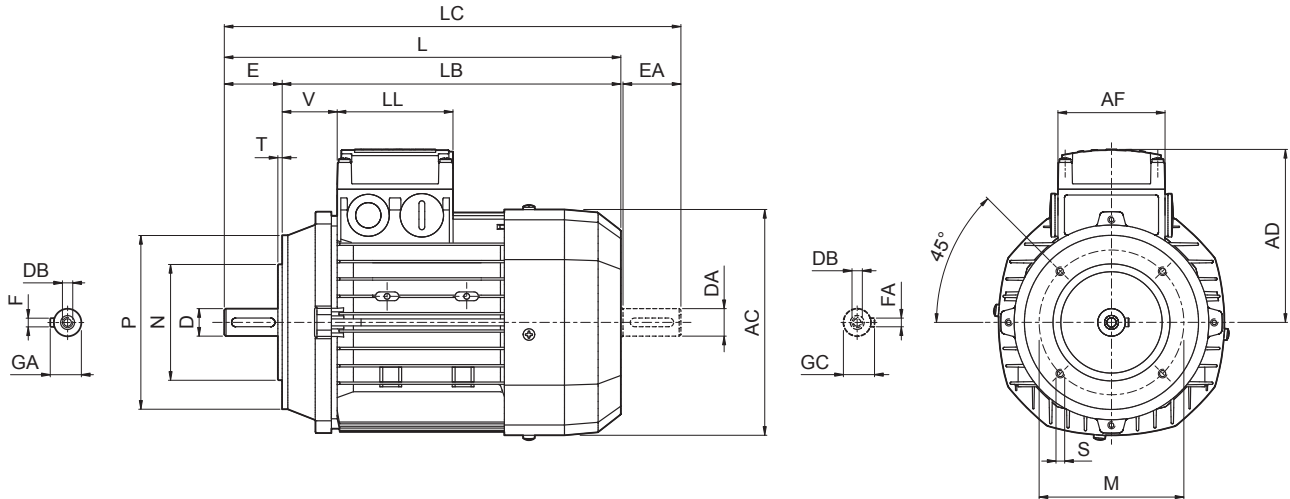



	Shaft					Flange					Motor							
	D DA	E EA	DB	GA GC	F FA	M	N	P	S	T	AC	L	LB	LC	AD	AF	LL	V
<b>BX 80</b>	19 14 <sup>(1)</sup>	40 30 <sup>(1)</sup>	M6 M5 <sup>(1)</sup>	21,5 16 <sup>(1)</sup>	6 5 <sup>(1)</sup>	100	80	120	M6	3	156	320	280	351	119	74	80	38
<b>BX 90</b>	24 19 <sup>(1)</sup>	50 40 <sup>(1)</sup>	M8 M6 <sup>(1)</sup>	27 21,5 <sup>(1)</sup>	8 6 <sup>(1)</sup>	115	95	140	M8		176	326	276	368	133			
<b>BX 100</b>	28 24 <sup>(1)</sup>	60 50 <sup>(1)</sup>	M10 M8 <sup>(1)</sup>	31 27 <sup>(1)</sup>	8 8 <sup>(1)</sup>	130	110	160		3.5	195	410	350	462	142	98	98	
<b>BX 112</b>											219	430	370	482	157			
<b>BX 132 SB</b>	38 28 <sup>(1)</sup>	80 60 <sup>(1)</sup>	M12 M10 <sup>(1)</sup>	41 31 <sup>(1)</sup>	10 8 <sup>(1)</sup>	165	130	200	M10	4	258	493	413	556	193	118	118	58
<b>BX 132 MA</b>												528	448	591				

N.B.:

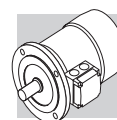
1) These values refer to the rear shaft end.

**15 MOTOR RATING CHARTS BE**



<b>2 P</b>		<b>3000 min<sup>-1</sup> - S1</b>										<b>50 Hz - IE2</b>		
<b>P<sub>n</sub></b> kW		<b>n</b> min <sup>-1</sup>	<b>M<sub>n</sub></b> Nm	<b>I<sub>n</sub></b> 400V A	<b>η%</b>			<b>cos φ</b>	$\frac{I_s}{I_n}$	$\frac{M_s}{M_n}$	$\frac{M_a}{M_n}$	<b>J<sub>m</sub></b> x 10 <sup>-4</sup> kgm <sup>2</sup>	<b>IM B5</b> Kg	
					100%	75%	50%							
0.75	<b>BE 80A</b>	2	2860	2.5	1.65	80.0	79.6	76.4	0.83	6.8	3.8	3.5	9.0	9.5
1.1	<b>BE 80B</b>	2	2845	3.7	2.35	81.5	82.2	79.9	0.83	6.9	3.8	3.1	11.4	11.3
1.5	<b>BE 90SA</b>	2	2865	5.0	3.2	81.3	80.7	78.1	0.82	6.8	3.6	2.8	12.5	12.3
2.2	<b>BE 90L</b>	2	2870	7.3	4.7	83.2	83.1	80.8	0.82	6.9	3.1	2.9	16.7	14
3	<b>BE 100L</b>	2	2880	9.9	6.2	84.6	84.6	83.7	0.83	7.3	3.5	3.1	39	23
4	<b>BE 112M</b>	2	2920	13.1	8.2	85.8	85.5	84.3	0.82	7.9	3.5	3.1	57	28
5.5	<b>BE 132SA</b>	2	2925	18.0	10.6	87.0	85.0	81.7	0.86	8.5	3.6	3.3	145	42
7.5	<b>BE 132SB</b>	2	2935	24	14.3	88.1	87.4	84.7	0.86	8.8	3.9	3.6	178	53
9.2	<b>BE 132MB</b>	2	2920	30	16.4	88.8	86.5	84.2	0.91	8.4	3.7	3.3	210	65
11	<b>BE 160MA</b>	2	2940	36	20.0	89.4	89.5	88.0	0.89	8.1	3.0	2.9	340	84
15	<b>BE 160MB</b>	2	2950	49	27.2	90.5	90.5	89.5	0.88	8.5	3.0	2.8	420	97
18.5	<b>BE 160L</b>	2	2945	60	32	90.9	90.5	89.8	0.91	7.7	2.9	2.7	490	109

<b>4 P</b>		<b>1500 min<sup>-1</sup> - S1</b>										<b>50 Hz - IE2</b>		
<b>P<sub>n</sub></b> kW		<b>n</b> min <sup>-1</sup>	<b>M<sub>n</sub></b> Nm	<b>I<sub>n</sub></b> 400V A	<b>η%</b>			<b>cos φ</b>	$\frac{I_s}{I_n}$	$\frac{M_s}{M_n}$	$\frac{M_a}{M_n}$	<b>J<sub>m</sub></b> x 10 <sup>-4</sup> kgm <sup>2</sup>	<b>IM B5</b> Kg	
					100%	75%	50%							
0.75	<b>BE 80B</b>	4	1430	5.0	1.65	81.0	80.5	78.0	0.81	6.1	3.2	3.0	28	12.2
1.1	<b>BE 90S</b>	4	1430	7.4	2.53	82.5	82.0	79.5	0.76	6.3	2.9	2.8	28	13.6
1.5	<b>BE 90LA</b>	4	1430	10.0	3.5	83.5	83.0	80.0	0.74	5.9	3.1	3.0	34	15.1
2.2	<b>BE 100LA</b>	4	1430	14.7	4.9	85.4	85.0	84.0	0.76	5.8	3.0	2.8	54	22
3	<b>BE 100LB</b>	4	1420	20	6.6	85.5	86.0	85.5	0.77	5.9	2.8	2.6	61	24
4	<b>BE 112M</b>	4	1440	27	8.3	87.0	87.0	86.0	0.80	6.5	2.8	2.8	105	32
5.5	<b>BE 132S</b>	4	1460	36	11.1	88.5	88.5	87.5	0.81	7.3	2.9	2.9	270	53
7.5	<b>BE 132MA</b>	4	1460	49	14.8	89.0	89.0	88.5	0.82	6.9	2.9	2.8	319	59
9.2	<b>BE 132MB</b>	4	1460	60	18.1	89.5	89.5	88.5	0.82	6.9	2.9	3.0	360	70
11	<b>BE 160M</b>	4	1465	72	21.5	91.0	91.3	90.5	0.81	6.5	2.8	2.6	650	99
15	<b>BE 160L</b>	4	1465	98	28.7	90.8	91.0	90.5	0.83	6.5	2.6	2.3	790	115
18.5	<b>BE 180M</b>	4	1465	121	35	91.6	92.0	91.3	0.83	6.5	2.6	2.5	1250	135
22	<b>BE 180L</b>	4	1465	143	41	91.6	91.8	91.4	0.84	6.8	2.7	2.6	1650	157

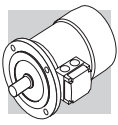



<b>6 P</b>	<b>1000 min<sup>-1</sup> - S1</b>	<b>50 Hz - IE2</b>
------------	-----------------------------------	--------------------

P <sub>n</sub> kW		n min <sup>-1</sup>	M <sub>n</sub> Nm	I <sub>n</sub> 400V A	η%			cos φ	$\frac{I_s}{I_n}$	$\frac{M_s}{M_n}$	$\frac{M_a}{M_n}$	J <sub>m</sub> x 10 <sup>-4</sup> kgm <sup>2</sup>	IM B5 
					100%	75%	50%						
0.75	<b>BE 90S 6</b>	935	7.7	2.06	75.9	75.9	73.0	0.69	5.1	3.1	2.9	33	15
1.1	<b>BE 100M 6</b> (*)	945	11.1	2.75	78.1	76.2	73.0	0.74	4.9	2.2	1.9	82	22
1.5	<b>BE 100LA 6</b>	945	15.2	3.9	79.8	77.5	74.0	0.72	5.6	2.5	2.3	95	24
2.2	<b>BE 112M 6</b>	950	22	5.2	81.8	81.8	79.3	0.74	5.2	2.6	2.3	168	32
3	<b>BE 132S 6</b>	955	30	6.6	83.3	83.3	82.4	0.79	6.1	2.1	1.9	295	44
4	<b>BE 132MA 6</b>	965	40	8.7	84.6	85.0	83.1	0.79	6.9	2.2	2.0	383	56
5.5	<b>BE 160MA 6</b> (*)	965	54	11.6	87.0	87.0	86.4	0.79	6.6	2.5	2.3	740	83
7.5	<b>BE 160MB 6</b> (*)	965	74	15.0	88.0	88.0	87.2	0.82	6.6	2.3	2.1	970	103

(\*) Power /size relation not standardized

**BE**

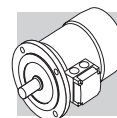

**BE - IM B3**

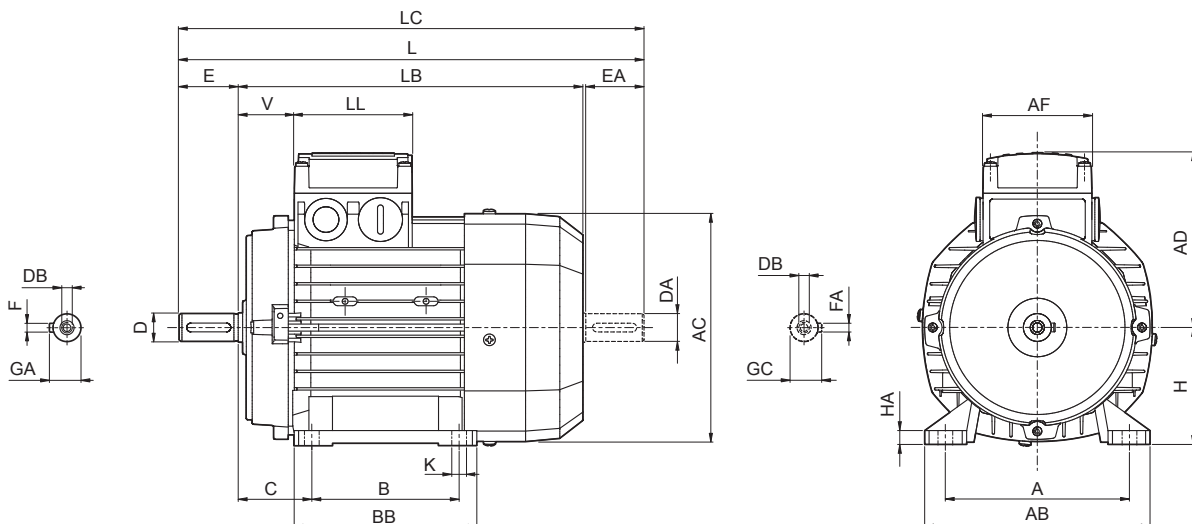

**BE**

	Shaft					Housing						Motor																									
	D DA	E EA	DB	GA GC	F FA	B	A	HA	BB	AB	K	C	H	AC	L	LB	LC	AD	AF	LL	V																
<b>BE 80</b>	19	40	M6	21.5	6	100	125	8	124	153	10	50	80	156	274	234	315	119	74	80	38																
<b>BE 90 S</b>	24	50	M8	27	8		140	8	155	174		63	90	176	326	276	378	133					44														
<b>BE 90 L</b>						125																	98	98													
<b>BE 100</b>	28	60	M10	31	10	160	10	175	192	70	112	219	385	325	448	157						50															
<b>BE 112</b>						140																	190	224	70	112	219	385	325	448	157						
<b>BE 132 S</b>	38	80	M12	41	10	178	216	12	218	254	12	89	132	258	493	413	576	193	118	118	58																
<b>BE 132 MA</b>																																					
<b>BE 132 MB</b>																																	528	448	611		
<b>BE 160 M</b>	42	110	M16	45	12	210	254	25	264	319	14.5	108	160	310	596	486	680	245				51															
<b>BE 160 L</b>	38 <sup>(1)</sup>	80 <sup>(1)</sup>	M12 <sup>(1)</sup>	41 <sup>(1)</sup>	10 <sup>(1)</sup>	254			304						319	596	486						680				640	530	724								
<b>BE 180 M</b>	48	110	M16	51.5	14	241	279	26	291	359	14	121	180	348	708	598	823	261				52															
<b>BE 180 L</b>	42 <sup>(1)</sup>	110 <sup>(1)</sup>	M16 <sup>(1)</sup>	45 <sup>(1)</sup>	12 <sup>(1)</sup>	279			329						359	708	598						823														

N.B.:  
1) These values refer to the rear shaft end.

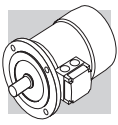

# BE - IM B5

**BE**

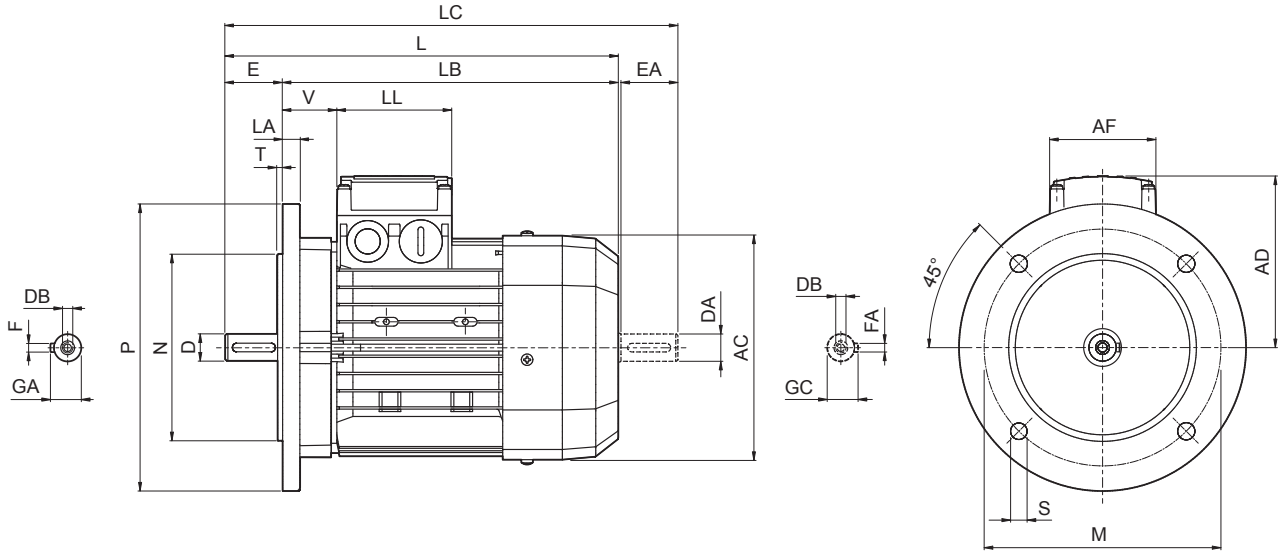

	Shaft					Flange					Motor																		
	D DA	E EA	DB	GA GC	F FA	M	N	P	S	T	LA	AC	L	LB	LC	AD	AF	LL	V										
<b>BE 80</b>	19	40	M6	21.5	6							156	274	234	315	119	74	80	38										
<b>BE 90 S</b>	24	50	M8	27	8	165	130	200	11.5	3.5	11.5	176	326	276	378	133			44										
<b>BE 90 L</b>																													
<b>BE 100</b>	28	60	M10	31	8	215	180	250	14	4	14	195	367	307	429	142	98	98	50										
<b>BE 112</b>												15	219	385	325	448	157												
<b>BE 132 S</b>	38	80	M12	41	10	265	230	300	14	4	20	258	493	413	576	193	118	118	58										
<b>BE 132 MA</b>																													
<b>BE 132 MB</b>																							528	448	611				
<b>BE 160 M</b>	42	110	M16	45	12								596	486	680				51										
<b>BE 160 L</b>	38 <sup>(1)</sup>	80 <sup>(1)</sup>	M12 <sup>(1)</sup>	41 <sup>(1)</sup>	10 <sup>(1)</sup>						15	310	640	530	724	245													
<b>BE 180 M</b>	48	110	M16	51.5	14	300	250	350	18.5	5	18	348	708	598	823	261	187	187	52										
<b>BE 180 L</b>																				42 <sup>(1)</sup>	110 <sup>(1)</sup>	M16 <sup>(1)</sup>	45 <sup>(1)</sup>	12 <sup>(1)</sup>					

N.B.:

1) These values refer to the rear shaft end.



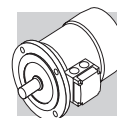

# BE - IM B14

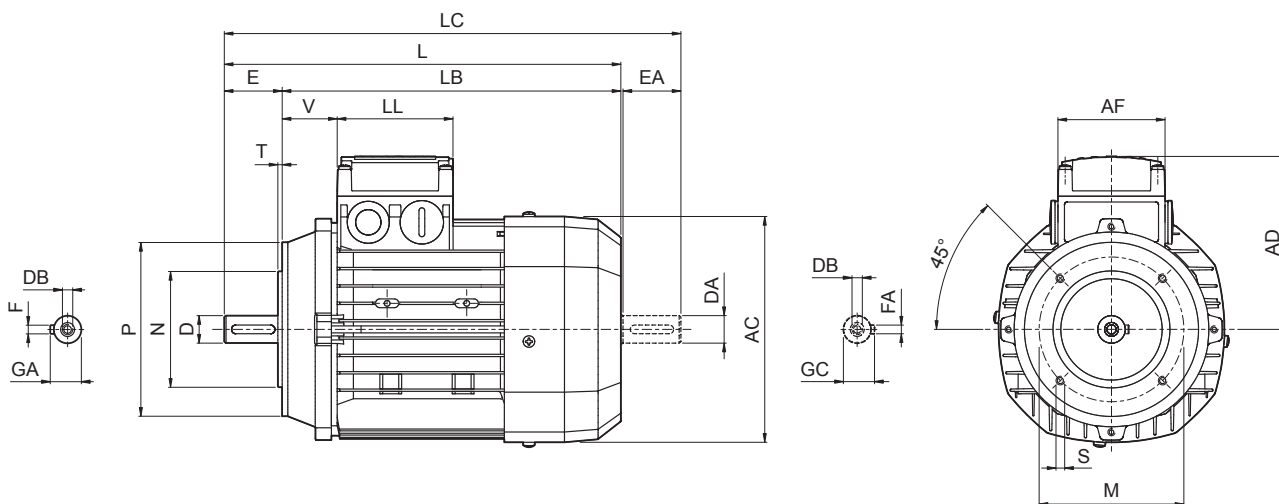

**BE**

	Shaft					Flange					Motor							
	D DA	E EA	DB	GA GC	F FA	M	N	P	S	T	AC	L	LB	LC	AD	AF	LL	V
<b>BE 80</b>	19	40	M6	21.5	6	100	80	120	M6	3	156	274	234	315	119	74	80	38
<b>BE 90 S</b>	24	50	M8	27	8	115	95	140	M8		176	326	276	378	133	98	98	44
<b>BE 90 L</b>										195	367	307	429	142	50			
<b>BE 100</b>	28	60	M10	31	8	130	110	160	M8	3.5	219	385	325	448	157	52		
<b>BE 112</b>											195	367	307	429	142			
<b>BE 132 S</b>	38	80	M12	41	10	165	130	200	M10	4	258	493	413	576	193	118	118	58
<b>BE 132 MA</b>												528	448	611				
<b>BE 132 MB</b>												528	448	611				

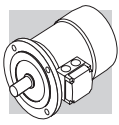

17 MOTOR RATING CHARTS BN

BN

2P		3000 min <sup>-1</sup> - S1														50 Hz										
P <sub>n</sub> kW		n min <sup>-1</sup>	M <sub>n</sub> Nm	IE1	η (100%) %	η (75%) %	η (50%) %	cosφ	In 400V A	Is In	Ms Mn	Ma Mn	J <sub>m</sub> x 10 <sup>-4</sup> kgm <sup>2</sup>	IM B5  Kg	d.c. brake						a.c. brake					
															Mod	Mb Nm	Z <sub>o</sub> 1/h	SB	J <sub>m</sub> x 10 <sup>-4</sup> kgm <sup>2</sup>	IM B5  Kg	Mod	Mb Nm	Z <sub>o</sub> 1/h	J <sub>m</sub> x 10 <sup>-4</sup> kgm <sup>2</sup>	IM B5  Kg	
																										FD 02
0.18	BN 63A	2	2730	0.63	○	59.9	56.9	51.9	0.77	0.56	3.0	2.1	2.0	2.0	3.5	FD 02	1.75	3900	4800	2.6	5.2	FA 02	1.75	4800	2.6	5.0
0.25	BN 63B	2	2740	0.87	○	66.0	64.8	64.8	0.76	0.72	3.3	2.3	2.3	2.3	3.9	FD 02	1.75	3900	4800	3.0	5.6	FA 02	1.75	4800	3.0	5.4
0.37	BN 63C	2	2800	1.26	○	69.1	66.8	66.8	0.78	0.99	3.9	2.6	2.6	3.3	5.1	FD 02	3.5	3600	4500	3.9	6.8	FA 02	3.5	4500	3.9	6.6
0.37	BN 71A	2	2820	1.25	○	73.8	73.0	70.6	0.76	0.95	4.8	2.8	2.6	3.5	5.4	FD 03	3.5	3000	4100	4.6	8.1	FA 03	3.5	4200	4.6	7.8
0.55	BN 71B	2	2820	1.86	○	76.0	75.8	74.8	0.76	1.37	5.0	2.9	2.8	4.1	6.2	FD 03	5	2900	4200	5.3	8.9	FA 03	5	4200	5.3	8.6
0.75	BN 71C	2	2810	2.6	○	76.6	76.2	76.2	0.76	1.86	5.1	3.1	2.8	5.0	7.3	FD 03	5	1900	3300	6.1	10.0	FA 03	5	3600	6.1	9.7
0.75	BN 80A	2	2810	2.6	●	76.2	75.5	68.3	0.81	1.75	4.8	2.6	2.2	7.8	8.6	FD 04	5	1700	3200	9.4	12.5	FA 04	5	3200	9.4	12.4
1.1	BN 80B	2	2800	3.8	●	76.4	76.2	75.0	0.81	2.57	4.8	2.8	2.4	9.0	9.5	FD 04	10	1500	3000	10.6	13.4	FA 04	10	3000	10.6	13.3
1.5	BN 80C	2	2800	5.1	●	79.1	79.5	77.2	0.81	3.4	4.9	2.7	2.4	11.4	11.3	FD 04	15	1300	2600	13.0	15.2	FA 04	15	2600	13.0	15.1
1.5	BN 90SA	2	2870	5.0	●	82.0	81.5	78.1	0.80	3.4	5.9	2.7	2.6	12.5	12.3	FD 14	15	900	2200	14.1	16.5	FA 14	15	2200	14.1	16.4
1.85	BN 90SB	2	2880	6.1	●	82.5	82.0	75.4	0.80	4.0	6.2	2.9	2.6	16.7	14	FD 14	15	900	2200	18.3	18.2	FA 14	15	2200	18.3	18.1
2.2	BN 90L	2	2880	7.3	●	82.7	82.1	80.8	0.80	4.8	6.3	2.9	2.7	16.7	14	FD 05	26	900	2200	21	20	FA 05	26	2200	21	20.7
3	BN 100L	2	2860	10.0	●	81.5	81.3	77.4	0.79	6.7	5.6	2.6	2.2	31	20	FD 15	26	700	1600	35	26	FA 15	26	1600	35	27
4	BN 100LB	2	2870	13.3	●	83.1	83.0	77.8	0.80	8.7	5.8	2.7	2.5	39	23	FD 15	40	450	900	43	29	FA 15	40	1000	43	30
4	BN 112M	2	2900	13.2	●	85.5	84.5	83.0	0.82	8.2	6.9	3.0	2.9	57	28	FD 06S	40	—	950	66	39	FA 06S	40	950	66	40
5.5	BN 132SA	2	2890	18.2	●	84.7	84.5	81.2	0.84	11.2	5.9	2.6	2.2	101	35	FD 06	50	—	600	112	48	FA 06	50	600	112	49
7.5	BN 132SB	2	2900	25	●	86.5	86.3	84.4	0.85	14.7	6.4	2.6	2.2	145	42	FD 06	50	—	550	154	55	FA 06	50	550	154	56
9.2	BN 132M	2	2930	30	●	87.0	86.5	83.6	0.86	17.7	6.7	2.8	2.3	178	53	FD 56	75	—	430	189	66	FA 06	75	430	189	67
11	BN 160MR	2	2920	36	●	87.6	87.0	86.0	0.88	20.6	6.9	2.9	2.5	210	65											
15	BN 160MB	2	2930	49	●	89.6	89.4	88.0	0.86	28.1	7.1	2.6	2.3	340	84											
18.5	BN 160L	2	2930	60	●	90.4	90.1	89.0	0.86	34	7.6	2.7	2.3	420	97											
22	BN 180M	2	2930	72	●	89.9	89.7	89.5	0.88	40	7.8	2.6	2.4	490	109											
30	BN 200LA	2	2930	98	●	90.7	90.1	87.6	0.89	54	7.8	2.7	2.9	770	140											

○ = n.a. ● = IE1

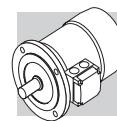

**4P** **1500 min<sup>-1</sup> - S1** **50 Hz**

P <sub>n</sub> kW	Image	n min <sup>-1</sup>	M <sub>n</sub> Nm	IE1	η (100%) %	η (75%) %	η (50%) %	cosφ	In 400V A	Is In	Ms Mn	Ma Mn	J <sub>m</sub> x 10 <sup>-4</sup> kgm <sup>2</sup>	IM B5  Kg	d.c. brake						a.c. brake					
															FD			FA			FD			FA		
															Mod	Mb Nm	Z <sub>0</sub> 1/h	NB	SB	Mod	Mb Nm	Z <sub>0</sub> 1/h	IM B5  Kg	J <sub>m</sub> x 10 <sup>-4</sup> kgm <sup>2</sup>	Mod	Mb Nm
0.06	BN 56A	4	0.43	○	46.8	44.2	41.3	0.65	0.28	2.6	2.3	2.0	1.5	3.1	FD 02	1.75	10000	13000	10000	FA 02	1.75	13000	13000	2.6	5.0	
0.09	BN 56B	4	0.64	○	51.7	47.6	42.9	0.60	0.42	2.6	2.5	2.4	1.5	3.1	FD 02	3.5	10000	13000	10000	FA 02	3.5	13000	13000	3.0	5.4	
0.12	BN 63A	4	0.85	○	59.8	56.2	47.0	0.62	0.47	2.6	1.9	1.8	2.0	3.5	FD 02	3.5	7800	10000	10000	FA 02	3.5	10000	10000	3.9	6.6	
0.18	BN 63B	4	1.30	○	54.8	52.9	52.5	0.67	0.71	2.6	2.2	2.0	2.3	3.9	FD 03	5	6000	9400	6000	FA 03	5	9400	9400	8.0	8.3	
0.25	BN 63C	4	1.78	○	65.3	65.0	57.9	0.69	0.80	2.7	2.1	1.9	3.3	5.1	FD 53	7.5	4300	8700	4300	FA 03	7.5	8700	8700	10.2	9.7	
0.25	BN 71A	4	1.73	○	63.7	62.2	59.1	0.73	0.78	3.3	1.9	1.7	5.8	5.1	FD 03	3.5	7700	11000	7700	FA 03	3.5	11000	11000	6.9	7.5	
0.37	BN 71B	4	2.6	○	66.8	66.7	63.0	0.76	1.05	3.7	2.0	1.9	6.9	5.9	FD 03	5	6000	9400	6000	FA 03	5	9400	9400	8.0	8.3	
0.55	BN 71C	4	3.8	○	69.0	68.9	68.8	0.74	1.55	4.1	2.3	2.3	9.1	7.3	FD 04	15	2600	5300	2600	FA 04	15	5300	5300	27	15.1	
0.55	BN 80A	4	3.8	○	72.0	71.3	69.7	0.77	1.43	4.1	2.3	2.0	15	8.2	FD 04	10	4100	8000	4100	FA 04	10	8000	8000	16.6	12.0	
0.75	BN 80B	4	5.1	●	75.0	74.5	69.3	0.78	1.85	4.9	2.7	2.5	20	9.9	FD 04	15	4100	7800	4100	FA 04	15	7800	7800	22	13.7	
1.1	BN 80C	4	7.5	●	75.5	76.2	70.4	0.78	2.7	5.1	2.8	2.5	25	11.3	FD 04	15	2600	5300	2600	FA 04	15	5300	5300	27	15.1	
1.1	BN 90S	4	7.6	●	76.5	76.2	72.2	0.77	2.70	4.6	2.6	2.2	21	12.2	FD 14	15	4800	8000	4800	FA 14	15	8000	8000	23	16.3	
1.5	BN 90LA	4	10.2	●	78.7	78.5	74.9	0.77	3.6	5.3	2.8	2.4	28	13.6	FD 05	26	3400	6000	3400	FA 05	26	6000	6000	32	20.3	
1.85	BN 90LB	4	12.7	●	78.6	78.9	77.2	0.79	4.3	5.1	2.8	2.6	30	15.1	FD 05	26	3200	5900	3200	FA 05	26	5900	5900	34	21.8	
2.2	BN 100LA	4	14.9	●	81.1	81.4	79.9	0.75	5.2	4.5	2.2	2.0	40	18	FD 15	40	2600	4700	2600	FA 15	40	4700	4700	44	25	
3	BN 100LB	4	20	●	82.6	83.8	83.7	0.77	6.8	5.0	2.3	2.2	54	22	FD 15	40	2400	4400	2400	FA 15	40	4400	4400	58	29	
4	BN 112M	4	27	●	84.4	84.2	81.6	0.81	8.4	5.6	2.7	2.5	98	30	FD 06S	60	—	1400	—	FA 06S	60	2100	2100	107	42	
5.5	BN 132S	4	36	●	84.7	84.8	82.5	0.81	11.6	5.5	2.3	2.2	213	44	FD 56	75	—	1050	—	FA 06	75	1200	1200	223	58	
7.5	BN 132MA	4	50	●	86.0	86.3	85.3	0.81	15.5	5.7	2.5	2.4	270	53	FD 06	100	—	950	—	FA 07	100	1000	1000	280	71	
9.2	BN 132MB	4	61	●	88.4	88.6	87.5	0.81	18.8	5.9	2.7	2.5	319	59	FD 07	150	—	900	—	FA 07	150	900	900	342	77	
11	BN 160MR	4	73	●	87.6	87.8	86.0	0.81	22.4	6.0	2.7	2.5	360	70	FD 07	150	—	850	—	FA 07	150	850	850	382	88	
15	BN 160L	4	98	●	88.7	88.5	88.4	0.81	30	6.0	2.3	2.1	650	99	FD 08	200	—	750	—	FA 08	200	750	750	710	128	
18.5	BN 180M	4	121	●	89.3	89.5	89.2	0.81	37	6.2	2.6	2.5	790	115	FD 08	250	—	700	—	FA 08	250	700	700	850	144	
22	BN 180L	4	144	●	89.9	90.0	90.0	0.80	44	6.4	2.5	2.5	1250	135	FD 09	300	—	400	—	FA 09	300	400	400	1450	175	
30	BN 200L	4	196	●	91.4	91.7	91.0	0.80	59	7.1	2.7	2.8	1650	157	FD 09	400	—	300	—	FA 09	400	300	300	1850	197	

○ = n.a.      ● = IE1



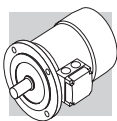

6P		1000 min <sup>-1</sup> - S1																50 Hz																					
		d.c. brake																a.c. brake																					
		P <sub>n</sub> kW	Image	n min <sup>-1</sup>	M <sub>n</sub> Nm	IE1	η (100%) %	η (75%) %	η (50%) %	cosφ	I <sub>n</sub> 400V A	I <sub>s</sub> I <sub>n</sub>	M <sub>s</sub> M <sub>n</sub>	M <sub>a</sub> M <sub>n</sub>	J <sub>m</sub> x 10 <sup>-4</sup> kgm <sup>2</sup>	IM B5 Kg	Mod	Mb Nm	Z <sub>0</sub> 1/h	SB	J <sub>m</sub> x 10 <sup>-4</sup> kgm <sup>2</sup>	IM B5 Kg	Mod	Mb Nm	Z <sub>0</sub> 1/h	J <sub>m</sub> x 10 <sup>-4</sup> kgm <sup>2</sup>	IM B5 Kg												
FD 02	FD 02																											FD 03	FD 03	FD 53	FD 04	FD 04	FD 04	FD 04	FD 14	FD 05	FD 15	FD 15	FD 06S
0.09	BN 63A	6	0.98	○	41.0	41.0	32.9	0.53	0.60	2.1	2.1	1.8	3.4	4.6	FD 02	3.5	9000	14000	4.0	6.3	FA 02	3.5	14000	4.0	6.1														
0.12	BN 63B	6	1.32	○	45.0	44.0	41.8	0.60	0.64	2.1	1.9	1.7	3.7	4.9	FD 02	3.5	9000	14000	4.3	6.6	FA 02	3.5	14000	4.3	6.4														
0.18	BN 71A	6	1.91	○	55.0	55.5	51.0	0.69	0.68	2.6	1.9	1.7	8.4	5.5	FD 03	5	8100	13500	9.5	8.2	FA 03	5.0	13500	9.5	7.9														
0.25	BN 71B	6	2.70	○	62.0	58.5	51.4	0.71	0.82	2.6	1.9	1.7	10.9	6.7	FD 03	5	7800	13000	12	9.4	FA 03	5.0	13000	12	9.1														
0.37	BN 71C	6	3.9	○	66.0	60.0	53.3	0.69	1.17	3.0	2.4	2.0	12.9	7.7	FD 53	7.5	5100	9500	14	10.4	FA 03	7.5	9500	14	10.1														
0.37	BN 80A	6	3.9	○	68.0	67.4	63.3	0.68	1.15	3.2	2.2	2.0	21	9.9	FD 04	10	5200	8500	23	13.8	FA 04	10	8500	23	13.7														
0.55	BN 80B	6	5.7	○	70.0	69.8	64.3	0.68	1.67	3.9	2.6	2.2	25	11.3	FD 04	15	4800	7200	27	15.2	FA 04	15	7200	27	15.1														
0.75	BN 80C	6	7.8	●	70.0	70.0	64.4	0.65	2.38	3.8	2.5	2.2	28	12.2	FD 04	15	3400	6400	30	16.1	FA 04	15	6400	30	16.0														
0.75	BN 90S	6	7.8	●	70.0	69.0	64.2	0.68	2.27	3.8	2.4	2.2	26	12.6	FD 14	15	3400	6500	28	16.8	FA 14	15	6500	28	16.7														
1.1	BN 90L	6	11.4	●	72.9	72.6	69.1	0.69	3.2	3.9	2.3	2.0	33	15	FD 05	26	2700	5000	37	21	FA 05	26	5000	37	22														
1.5	BN 100LA	6	15.2	●	75.2	74.2	70.3	0.72	4.0	4.1	2.1	2.0	82	22	FD 15	40	1900	4100	86	28	FA 15	40	4100	86	29														
1.85	BN 100LB	6	19.0	●	76.6	72.8	62.6	0.73	4.8	4.6	2.1	2.0	95	24	FD 15	40	1700	3600	99	30	FA 15	40	3600	99	31														
2.2	BN 112M	6	22	●	78.5	79.0	76.5	0.73	5.5	4.8	2.2	2.0	168	32	FD 06S	60	—	2100	177	42	FA 06S	60	2100	177	44														
3	BN 132S	6	30	●	79.7	77.0	75.1	0.76	7.1	5.1	1.9	1.8	216	36	FD 56	75	—	1400	226	49	FA 06	75	1400	226	50														
4	BN 132MA	6	40	●	81.4	81.5	79.5	0.77	9.2	5.5	2.0	1.8	295	45	FD 06	100	—	1200	305	58	FA 07	100	1200	318	63														
5.5	BN 132MB	6	56	●	83.1	80.9	79.1	0.78	12.2	6.1	2.1	1.9	383	56	FD 07	150	—	1050	406	72	FA 07	150	1050	406	74														
7.5	BN 160M	6	75	●	85.0	85.0	84.8	0.81	15.7	5.9	2.2	2.0	740	83	FD 08	170	—	900	815	112	FA 08	170	900	815	113														
11	BN 160L	6	109	●	86.4	86.5	85.9	0.81	22.7	6.6	2.5	2.3	970	103	FD 08	200	—	800	1045	133	FA 08	200	800	1045	133														
15	BN 180L	6	148	●	87.7	88.0	87.3	0.82	30	6.2	2.0	2.4	1550	130	FD 09	300	—	600	1750	170	—	—	600	1750	170	—													
18.5	BN 200LA	6	184	●	88.6	88.0	87.3	0.81	37	5.9	2.0	2.3	1700	145	FD 09	400	—	450	1900	185	—	—	450	1900	185	—													



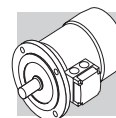

○ = n.a.      ● = IE1



8P

750 min<sup>-1</sup> - S1

50 Hz

P <sub>n</sub> kW		n min <sup>-1</sup>	M <sub>n</sub> Nm	η %	cosφ	I <sub>n</sub> 400V A	$\frac{I_s}{I_n}$	$\frac{M_s}{M_n}$	$\frac{M_a}{M_n}$	$\frac{J_m}{kgm^2} \times 10^{-4}$	IM B5 	d.c. brake							a.c. brake						
												FD			FA				FD			FA			
												Mod	Mb Nm	Z <sub>0</sub> 1/h	NB	SB	J <sub>m</sub> kgm <sup>2</sup> × 10 <sup>-4</sup>	IM B5 	Mod	Mb Nm	Z <sub>0</sub> 1/h	J <sub>m</sub> kgm <sup>2</sup> × 10 <sup>-4</sup>	IM B5 		
0.09	BN 71A	8	1.26	47	0.59	0.47	2.3	2.4	2.3	10.9	6.7	FD 03	3.5	9000	16000	12.0	9.4	FA 03	3.5	16000	12.0	9.1			
0.12	BN 71B	8	1.69	51	0.59	0.58	2.1	2.3	2.2	12.9	7.7	FD 03	5.0	9000	16000	14.0	10.4	FA 03	5.0	16000	14.0	10.1			
0.18	BN 80A	8	2.49	51	0.60	0.85	2.4	2.2	2.2	15	8.2	FD 04	5.0	6500	11000	16.6	12.1	FA 04	5.0	11000	16.6	12.0			
0.25	BN 80B	8	3.51	54	0.63	1.06	2.4	2.0	1.9	20	9.9	FD 04	10.0	6000	10000	22	13.8	FA 04	10.0	10000	23	13.7			
0.37	BN 90S	8	5.2	58	0.60	1.53	2.6	2.3	2.1	26	12.6	FD 14	15.0	4800	7500	28	16.8	FA 14	15.0	7500	28	16.7			
0.55	BN 90L	8	7.8	62	0.60	2.13	2.6	2.2	2.0	33	15	FD 05	26	4000	6400	37	21	FA 05	26	6400	37	22			
0.75	BN 100LA	8	10.2	68	0.63	2.53	3.4	1.9	1.7	82	22	FD 15	26	2800	4800	86	28	FA 15	26	4800	86	29			
1.1	BN 100LB	8	15.0	68	0.64	3.65	3.2	1.7	1.7	95	24	FD 15	40	2500	4000	99	30	FA 15	40	4000	99	31			
1.5	BN 112M	8	20.2	71	0.66	4.6	3.7	1.8	1.9	168	32	FD 06S	60	—	3000	177	42	FA 06S	60	3000	177	44			
2.2	BN 132S	8	29.6	75	0.66	6.4	3.8	1.8	2.0	295	45	FD 06	75	—	2300	305	58	FA 06	75	2300	305	56			
3	BN 132MA	8	40.4	76	0.69	8.3	3.9	1.6	1.8	370	53	FD 06	100	—	1900	394	69	FA 07	100	1900	406	74			

BN

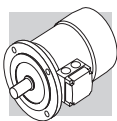

**50 Hz**

**3000/1500 min<sup>-1</sup> - S1**

**2/4P**

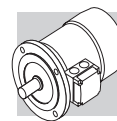

P <sub>n</sub> kW		n min <sup>-1</sup>	M <sub>n</sub> Nm	η %	cosφ	I <sub>n</sub> 400V A	I <sub>s</sub> I <sub>n</sub>	M <sub>s</sub> M <sub>n</sub>	M <sub>a</sub> M <sub>n</sub>	J <sub>m</sub> x 10 <sup>-4</sup> kgm <sup>2</sup>	IM B5 	d.c. brake						a.c. brake					
												FD			FA			FD			FA		
												Mod	Mb Nm	Z <sub>0</sub> 1/h	NB	SB	J <sub>m</sub> x 10 <sup>-4</sup> kgm <sup>2</sup>	IM B5 	Mod	Mb Nm	Z <sub>0</sub> 1/h	J <sub>m</sub> x 10 <sup>-4</sup> kgm <sup>2</sup>	IM B5 
0.20	<b>BN 63B</b>	2	2700	0.71	0.82	0.64	3.5	2.1	1.9	2.9	4.4	FD 02	3.5	2200	2600	3.5	6.1	FA 02	3.5	2600	3.5	5.9	
0.15		4	1350	1.06	0.67	0.66	2.6	1.8	1.7			4000	5100										
0.28	<b>BN 71A</b>	2	2700	0.99	0.82	0.88	2.9	1.9	1.7	4.7	4.4	FD 03	3.5	2100	2400	5.8	7.1	FA 03	3.5	2400	5.8	6.8	
0.20		4	1370	1.39	0.72	0.88	3.1	1.8	1.7			3800	4800										
0.37	<b>BN 71B</b>	2	2740	1.29	0.82	1.16	3.5	1.8	1.8	5.8	5.1	FD 03	5.0	1400	2100	6.9	7.8	FA 03	5.0	2100	6.9	7.5	
0.25		4	1390	1.72	0.73	0.82	3.3	2.0	1.9			2900	4200										
0.45	<b>BN 71C</b>	2	2780	1.55	0.85	1.21	3.8	1.8	1.8	6.9	5.9	FD 03	5.0	1400	2100	8.0	8.6	FA 03	5.0	2100	8.0	8.3	
0.30		4	1400	2.0	0.73	0.94	3.6	2.0	1.9			2900	4200										
0.55	<b>BN 80A</b>	2	2800	1.9	0.85	1.48	3.9	1.7	1.7	15	8.2	FD 04	5.0	1600	2300	17	12.1	FA 04	5.0	2300	16.6	12.0	
0.37		4	1400	2.5	0.79	1.01	4.1	1.8	1.9			3000	4000										
0.75	<b>BN 80B</b>	2	2780	2.6	0.85	1.96	3.8	1.9	1.8	20	9.9	FD 04	10	1400	1600	22	13.8	FA 04	10	1600	22	13.7	
0.55		4	1400	3.8	0.81	1.44	3.9	1.7	1.7			2700	3600										
1.1	<b>BN 90S</b>	2	2790	3.8	0.82	2.73	4.7	2.3	2.0	21	12.2	FD 14	10	1500	1600	23	16.4	FA 14	10	1600	23	16.3	
0.75		4	1390	5.2	0.79	2.08	4.6	2.4	2.2			2300	2800										
1.5	<b>BN 90L</b>	2	2780	5.2	0.85	3.64	4.5	2.4	2.1	28	14.0	FD 05	26	1050	1200	32	20	FA 05	26	1200	32	21	
1.1		4	1390	7.6	0.81	2.89	4.7	2.5	2.2			1600	2000										
2.2	<b>BN 100LA</b>	2	2800	7.5	0.85	5.2	4.5	2.0	1.9	40	18.3	FD 15	26	600	900	44	25	FA 15	26	900	44	25	
1.5		4	1410	10.2	0.79	3.8	4.7	2.0	2.0			1300	2300										
3.5	<b>BN 100LB</b>	2	2850	11.7	0.84	7.5	5.4	2.2	2.1	61	25	FD 15	40	500	900	65	31	FA 15	40	900	65	32	
2.5		4	1420	16.8	0.80	5.5	5.2	2.2	2.2			1000	2100										
4	<b>BN 112M</b>	2	2880	13.3	0.83	8.8	6.1	2.4	2.0	98	30	FD 06S	60	—	700	107	40	FA 06S	60	700	107	42	
3.3		4	1420	22.2	0.80	7.4	5.1	2.1	2.0			—	—	—	—	—	—	—	—	—	—	—	
5.5	<b>BN 132S</b>	2	2890	18.2	0.87	11.4	5.9	2.4	2.0	213	44	FD 56	75	—	350	223	57	FA 06	75	350	223	58	
4.4		4	1440	29	0.84	9.2	5.3	2.2	2.0			—	—	—	—	—	—	—	—	—	—	—	
7.5	<b>BN 132MA</b>	2	2900	25	0.87	15.2	6.5	2.4	2.0	270	53	FD 06	100	—	350	280	66	FA 07	100	350	280	71	
6		4	1430	40	0.85	12.1	5.8	2.3	2.1			—	—	—	—	—	—	—	—	—	—	—	
9.2	<b>BN 132MB</b>	2	2920	30	0.86	18.6	6.0	2.6	2.2	319	59	FD 07	150	—	300	342	75	FA 07	150	300	342	77	
7.3		4	1440	48	0.85	14.6	5.5	2.3	2.1			—	—	—	—	—	—	—	—	—	—	—	



2/6P

3000/1000 min<sup>-1</sup> - S3 60/40%



50 Hz

P <sub>n</sub> kW		n min <sup>-1</sup>	M <sub>n</sub> Nm	η %	cosφ	I <sub>n</sub> 400V A	I <sub>s</sub> I <sub>n</sub>	M <sub>s</sub> M <sub>n</sub>	M <sub>a</sub> M <sub>n</sub>	J <sub>m</sub> x 10 <sup>-4</sup> kgm <sup>2</sup>	IM B5 	Mod	d.c. brake				a.c. brake					
													FD				FA					
													Mb Nm	Z <sub>0</sub> 1/h	NB	SB	Mb Nm	Z <sub>0</sub> 1/h	IM B5 	J <sub>m</sub> x 10 <sup>-4</sup> kgm <sup>2</sup>	Mb Nm	Z <sub>0</sub> 1/h
0.25	BN 71A	2850	0.84	60	0.82	0.73	4.3	1.9	1.8	6.9	5.9	FD 03	1.75	1500	1700	1500	8.0	2.5	1700	8.0	8.3	
0.08		910	0.84	43	0.70	0.38	2.1	1.4	1.5					10000	13000	10000			13000			
0.37	BN 71B	2880	1.23	62	0.80	1.08	4.4	1.9	1.8	9.1	7.3	FD 03	3.5	1000	1300	1000	10.2	3.5	1300	10.2	9.7	
0.12		900	1.27	44	0.73	0.54	2.4	1.4	1.5					9000	11000	9000			11000			
0.55	BN 80A	2800	1.88	63	0.86	1.47	4.5	1.9	1.7	20	9.9	FD 04	5.0	1500	1800	1500	22	5.0	1800	22	13.7	
0.18		930	1.85	52	0.65	0.77	3.3	2.0	1.9					4100	6300	4100			6300			
0.75	BN 80B	2800	2.6	66	0.87	1.89	4.3	1.8	1.6	25	11.3	FD 04	5.0	1700	1900	1700	27	5.0	1900	27	15.1	
0.25		930	2.6	54	0.67	1.00	3.2	1.7	1.8					3800	6000	3800			6000			
1.10	BN 90L	2860	3.7	67	0.84	2.82	4.7	2.1	1.9	28	14.0	FD 05	13	1400	1600	1400	32	13	1600	32	21	
0.37		920	3.8	59	0.71	1.27	3.3	1.6	1.6					3400	5200	3400			5200			
1.5	BN 100LA	2880	5	73	0.84	3.53	5.1	1.9	2.0	40	18.3	FD 15	13	1000	1200	1000	44	13	1200	44	25	
0.55		940	5.6	64	0.67	1.85	3.5	1.7	1.8					2900	4000	2900			4000			
2.2	BN 100LB	2900	7.2	77	0.85	4.9	5.9	2.0	2.0	61	25	FD 15	26	700	900	700	65	26	900	65	32	
0.75		950	7.5	67	0.64	2.5	3.3	1.9	1.8					2100	3000	2100			3000			
3	BN 112M	2900	9.9	78	0.87	6.4	6.3	2.0	2.1	98	30	FD 06S	40	—	1000	1000	107	40	40	1000	107	32
1.1		950	11.1	72	0.64	3.4	3.9	1.8	1.8					—	2600	—			2600			
4.5	BN 132S	2910	14.8	78	0.84	9.9	5.8	1.9	1.8	213	44	FD 56	37	—	500	500	223	37	500	223	58	
1.5		960	14.9	74	0.67	4.4	4.2	1.9	2.0					—	2100	—			2100			
5.5	BN 132M	2920	18.0	78	0.87	11.7	6.2	2.1	1.9	270	53	FD 56	50	—	400	400	280	50	400	280	67	
2.2		960	22	77	0.71	5.8	4.3	2.1	2.0					—	1900	—			1900			

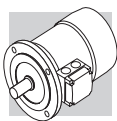
BN



**2/8P** **3000/750 min<sup>-1</sup> - S3 60/40%** **50 Hz**

P <sub>n</sub> kW		n min <sup>-1</sup>	M <sub>n</sub> Nm	η %	cosφ	I <sub>n</sub> 400V A	I <sub>s</sub> I <sub>n</sub>	M <sub>s</sub> M <sub>n</sub>	M <sub>a</sub> M <sub>n</sub>	J <sub>m</sub> x 10 <sup>-4</sup> kgm <sup>2</sup>	IM B5 	d.c. brake					a.c. brake					
												FD					FA					
												Mod	Mb Nm	Z <sub>0</sub> 1/h	NB	SB	J <sub>m</sub> x 10 <sup>-4</sup> kgm <sup>2</sup>	IM B5 	Mod	Mb Nm	Z <sub>0</sub> 1/h	J <sub>m</sub> x 10 <sup>-4</sup> kgm <sup>2</sup>
0.25	<b>BN 71A</b>	2 2790	0.86	61	0.87	0.68	3.9	1.8	1.9	10.9	6.7	<b>FD 03</b>	1.75	1300	1400	12	9.4	<b>FA 03</b>	2.5	1400	12	9.1
0.06		8 680	0.84	31	0.61	0.46	2.0	1.8	1.9					10000	13000					13000		
0.37	<b>BN 71B</b>	2 2800	1.26	63	0.86	0.99	3.9	1.8	1.9	12.9	7.7	<b>FD 03</b>	3.5	1200	1300	14	10.4	<b>FA 03</b>	3.5	1300	14	10.1
0.09		8 670	1.28	34	0.75	0.51	1.8	1.4	1.5					9500	13000					13000		
0.55	<b>BN 80A</b>	2 2830	1.86	66	0.86	1.40	4.4	2.1	2.0	20	9.9	<b>FD 04</b>	5.0	1500	1800	22	13.8	<b>FA 04</b>	5.0	1800	22	13.7
0.13		8 690	1.80	41	0.64	0.72	2.3	1.6	1.7					5600	8000					8000		
0.75	<b>BN 80B</b>	2 2800	2.6	68	0.88	1.81	4.6	2.1	2.0	25	11.3	<b>FD 04</b>	10	1700	1900	27	15.2	<b>FA 04</b>	10	1900	27	15.1
0.18		8 690	2.5	43	0.66	0.92	2.3	1.6	1.7					4800	7300					7300		
1.10	<b>BN 90L</b>	2 2830	3.7	63	0.84	3.00	4.5	2.1	1.9	28	14.0	<b>FD 05</b>	13	1400	1600	32	20	<b>FA 05</b>	13	1600	32	21
0.28		8 690	3.9	48	0.63	1.34	2.4	1.8	1.9					3400	5100					5100		
1.5	<b>BN 100LA</b>	2 2880	5.0	69	0.85	3.69	4.7	1.9	1.8	40	18.3	<b>FD 15</b>	13	1000	1200	44	25	<b>FA 15</b>	13	1200	44	25
0.37		8 690	5.1	46	0.63	1.84	2.1	1.6	1.6					3300	5000					5000		
2.4	<b>BN 100LB</b>	2 2900	7.9	75	0.82	5.6	5.4	2.1	2.0	61	25	<b>FD 15</b>	26	550	700	65	31	<b>FA 15</b>	26	700	65	32
0.55		8 700	7.5	54	0.58	2.5	2.6	1.8	1.8					2000	3500					3500		
3	<b>BN 112M</b>	2 2900	9.9	76	0.87	6.5	6.3	2.1	1.9	98	30	<b>FD 06S</b>	40	—	900	107	40	<b>FA 06S</b>	40	900	107	42
0.75		8 690	10.4	60	0.65	2.8	2.5	1.6	1.6					—	2900					2900		
4	<b>BN 132S</b>	2 2870	13.3	73	0.84	9.4	5.6	2.3	2.4	213	44	<b>FD 06</b>	37	—	500	223	57	<b>FA 06</b>	37	500	223	58
1		8 690	13.8	66	0.62	3.5	2.9	1.9	1.8					—	3500					3500		
5.5	<b>BN 132M</b>	2 2870	18.3	75	0.84	12.6	6.1	2.4	2.5	270	53	<b>FD 06</b>	50	—	400	280	66	<b>FA 06</b>	50	400	280	67
1.5		8 690	21	68	0.63	5.1	2.9	1.9	1.9					—	2400					2400		



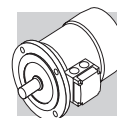



2/12P

3000/500 min<sup>-1</sup> - S3 60/40%

50 Hz

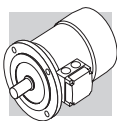

P <sub>n</sub> kW		n min <sup>-1</sup>	M <sub>n</sub> Nm	η %	cosφ	I <sub>n</sub> 400V A	I <sub>s</sub> I <sub>n</sub>	M <sub>s</sub> M <sub>n</sub>	M <sub>a</sub> M <sub>n</sub>	J <sub>m</sub> x 10 <sup>-4</sup> kgm <sup>2</sup>	IM B5 	Mod	Mb Nm	d.c. brake			a.c. brake					
														FD			FA					
														NB	Z <sub>0</sub> 1/h	SB	J <sub>m</sub> x 10 <sup>-4</sup> kgm <sup>2</sup>	IM B5 	Mod	Mb Nm	Z <sub>0</sub> 1/h	J <sub>m</sub> x 10 <sup>-4</sup> kgm <sup>2</sup>
0.55	<b>BN 80B</b>	2 2820	1.86	64	0.89	1.39	4.2	1.6	1.7	25	11.3	<b>FD 04</b>	5.0	1000	1300	27	15.2	<b>FA 04</b>	5.0	1300	27	15.1
0.09		12 430	2.0	30	0.63	0.69	1.8	1.9	1.8					8000	12000							
0.75	<b>BN 90L</b>	2 2790	2.6	56	0.89	2.17	4.2	1.8	1.7	26	12.6	<b>FD 05</b>	13	1000	1150	30	18.6	<b>FA 05</b>	13	1150	30	19.3
0.12		12 430	2.7	26	0.63	1.06	1.7	1.4	1.6					4600	6300							
1.10	<b>BN 100LA</b>	2 2850	3.7	65	0.85	2.87	4.5	1.6	1.8	40	18.3	<b>FD 15</b>	13	700	900	44	25	<b>FA 15</b>	13	900	44	25
0.18		12 430	4.0	26	0.54	1.85	1.5	1.3	1.5					4000	6000							
1.5	<b>BN 100LB</b>	2 2900	4.9	67	0.86	3.76	5.6	1.9	1.9	54	22	<b>FD 15</b>	13	700	900	58	28	<b>FA 15</b>	13	900	58	29
0.25		12 440	5.4	36	0.46	2.18	1.8	1.7	1.8					3800	5000							
2	<b>BN 112M</b>	2 2900	6.6	74	0.88	4.43	6.5	2.1	2.0	98	30	<b>FD 06S</b>	20	—	800	107	40	<b>FA 06S</b>	20	800	107	42
0.3		12 460	6.2	46	0.43	2.19	2.0	2.1	2.0					—	3400							
3	<b>BN 132S</b>	2 2920	9.8	74	0.87	6.7	6.8	2.3	1.9	213	44	<b>FD 56</b>	37	—	450	223	57	<b>FA 06</b>	37	450	223	58
0.5		12 470	10.2	51	0.43	3.3	2.0	1.7	1.6					—	3000							
4	<b>BN 132M</b>	2 2920	13.1	75	0.89	8.6	5.9	2.4	2.3	270	53	<b>FD 56</b>	37	—	400	280	66	<b>FA 06</b>	37	400	280	67
0.7		12 460	14.5	53	0.44	4.3	1.9	1.7	1.6					—	2800							



**4/6P**

**1500/1000 min<sup>-1</sup> - S1**

**50 Hz**

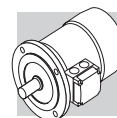

P <sub>n</sub> kW		n min <sup>-1</sup>	M <sub>n</sub> Nm	η %	cosφ	I <sub>n</sub> 400V A	I <sub>s</sub> I <sub>n</sub>	M <sub>s</sub> M <sub>n</sub>	M <sub>a</sub> M <sub>n</sub>	J <sub>m</sub> x 10 <sup>-4</sup> kgm <sup>2</sup>	IM B5 	d.c. brake						a.c. brake					
												FD			FA			FD			FA		
												Mod	Mb Nm	Z <sub>0</sub> 1/h	NB	SB	Mod	Mb Nm	Z <sub>0</sub> 1/h	J <sub>m</sub> x 10 <sup>-4</sup> kgm <sup>2</sup>	IM B5 	Mod	Mb Nm
0.22	<b>BN 71B</b>	4	1410	1.5	0.74	0.67	3.9	1.8	1.9	9.1	7.3	<b>FD 03</b>	3.5	2500	3500	10.2	10.0	<b>FA 03</b>	3.5	3500	10.2	9.7	
0.13		6	920	1.4	0.67	0.65	2.3	1.6	1.7				5000	9000						9000			
0.30	<b>BN 80A</b>	4	1410	2.0	0.82	0.87	3.5	1.3	1.5	15	8.2	<b>FD 04</b>	5.0	2500	3100	16.6	12.1	<b>FA 04</b>	5.0	3100	16.6	12.0	
0.20		6	930	2.1	0.66	0.81	3.2	1.9	2.0				4000	6000						6000			
0.40	<b>BN 80B</b>	4	1430	2.7	0.75	1.22	3.9	1.8	1.8	20	9.9	<b>FD 04</b>	10	1800	2300	22	13.8	<b>FA 04</b>	10	2300	22	13.7	
0.26		6	930	2.7	0.70	0.97	2.7	1.5	1.6				3600	5500						5500			
0.55	<b>BN 90S</b>	4	1420	3.7	0.78	1.45	4.5	2.0	1.9	21	12.2	<b>FD 14</b>	10	1500	2100	23	16.1	<b>FA 14</b>	10	2100	23	16.3	
0.33		6	930	3.4	0.70	1.10	3.7	2.3	2.0				2500	4100						4100			
0.75	<b>BN 90L</b>	4	1420	5.0	0.78	1.88	4.3	1.9	1.8	28	14	<b>FD 05</b>	13	1400	2000	32	20	<b>FA 05</b>	13	2000	32	21	
0.45		6	920	4.7	0.71	1.39	3.3	2.0	1.9				2300	3600						3600			
1.1	<b>BN 100LA</b>	4	1450	7.2	0.79	2.72	5.0	1.7	1.9	82	22	<b>FD 15</b>	26	1400	2000	86	28	<b>FA 15</b>	26	2000	86	29	
0.8		6	950	8.0	0.69	2.57	4.1	1.9	2.1				2100	3300						3300			
1.5	<b>BN 100LB</b>	4	1450	9.9	0.79	3.65	5.1	1.7	1.9	95	25	<b>FD 15</b>	26	1300	1800	99	31	<b>FA 15</b>	26	1800	99	32	
1.1		6	950	11.1	0.68	3.24	4.3	2.0	2.1				2000	3000						3000			
2.3	<b>BN 112M</b>	4	1450	15.2	0.78	5.7	5.2	1.8	1.9	168	32	<b>FD 06S</b>	40	—	1600	177	42	<b>FA 06S</b>	40	1600	177	44	
1.5		6	960	14.9	0.72	4.1	4.9	2.0	2.0				—	2400						2400			
3.1	<b>BN 132S</b>	4	1460	20	0.83	6.5	5.9	2.1	2.0	213	44	<b>FD 06</b>	37	—	1200	223	57	<b>FA 06</b>	37	1200	223	58	
2		6	960	20	0.75	4.9	4.5	2.1	2.1				—	1900						1900			
4.2	<b>BN 132MA</b>	4	1460	27	0.82	8.8	5.9	2.1	2.2	270	53	<b>FD 06</b>	50	—	900	280	66	<b>FA 06</b>	50	900	280	67	
2.6		6	960	26	0.72	6.6	4.3	2.0	2.0				—	1500						1500			



4/8P

1500/750 min<sup>-1</sup> - S1

50 Hz

P <sub>n</sub> kW		n min <sup>-1</sup>	M <sub>n</sub> Nm	η %	cosφ	I <sub>n</sub> 400V A	I <sub>s</sub> I <sub>n</sub>	M <sub>s</sub> M <sub>n</sub>	M <sub>a</sub> M <sub>n</sub>	J <sub>m</sub> x 10 <sup>-4</sup> kgm <sup>2</sup>	IM B5 	d.c. brake					a.c. brake						
												FD					FA						
												Mod	Mb Nm	Z <sub>0</sub> 1/h	NB	SB	Mod	Mb Nm	Z <sub>0</sub> 1/h	J <sub>m</sub> x 10 <sup>-4</sup> kgm <sup>2</sup>	IM B5 		
0.37	BN 80A	4	1400	2.5	63	0.82	1.03	3.3	1.4	1.4	15	8.2	FD 04	10	2300	3500	16.6	12.1	FA 04	10	3500	16.6	12.0
0.18		8	690	2.5	44	0.60	0.98	2.2	1.5	1.6					4500	7000							
0.55	BN 80B	4	1390	3.8	65	0.86	1.42	3.8	1.7	1.6	20	9.9	FD 04	10	2200	2900	22	13.8	FA 04	10	2900	22	13.7
0.30		8	670	4.3	49	0.65	1.36	2.3	1.7	1.8					4200	6500							
0.65	BN 90S	4	1390	4.5	73	0.85	1.51	4.0	1.9	1.9	28	13.6	FD 14	15	2300	2800	30	17.8	FA 14	15	2800	30	17.7
0.35		8	690	4.8	49	0.57	1.81	2.5	2.1	2.2					3500	6000							
0.9	BN 90L	4	1370	6.3	73	0.87	2.05	3.8	1.8	1.8	30	15.1	FD 05	26	1700	2100	34	21	FA 05	26	2100	34	22
0.5		8	670	7.1	57	0.62	2.04	2.4	2.1	2.0					2500	4200							
1.30	BN 100LA	4	1420	8.7	72	0.83	3.14	4.3	1.7	1.8	82	22	FD 15	40	1300	1700	86	28	FA 15	40	1700	86	29
0.70		8	700	9.6	58	0.64	2.72	2.8	1.8	1.8					2000	3400							
1.8	BN 100LB	4	1420	12.1	69	0.87	4.3	4.2	1.6	1.7	95	25	FD 15	40	1200	1700	99	31	FA 15	40	1700	99	32
0.9		8	700	12.3	62	0.63	3.3	3.2	1.7	1.8					1600	2600							
2.2	BN 112M	4	1440	14.6	77	0.85	4.9	5.3	1.8	1.8	168	32	FD 06S	60	—	1200	177	42	FA 06S	60	1200	177	43
1.2		8	710	16.1	70	0.63	3.9	3.3	1.9	1.8					—	2000							
3.6	BN 132S	4	1440	24	80	0.82	7.9	6.5	2.1	1.9	295	45	FD 56	75	—	1000	305	58	FA 06	75	1000	305	59
1.8		8	720	24	72	0.55	6.6	4.6	1.9	2.0					—	1400							
4.6	BN 132M	4	1450	30	81	0.83	9.9	6.5	2.2	1.9	383	56	FD 06	100	—	1000	393	69	FA 07	100	1000	406	74
2.3		8	720	31	73	0.54	8.4	4.4	2.3	2.0					—	1300							

BN

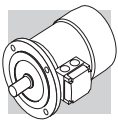

18 MOTORS DIMENSIONS BN

**BN - IM B3**

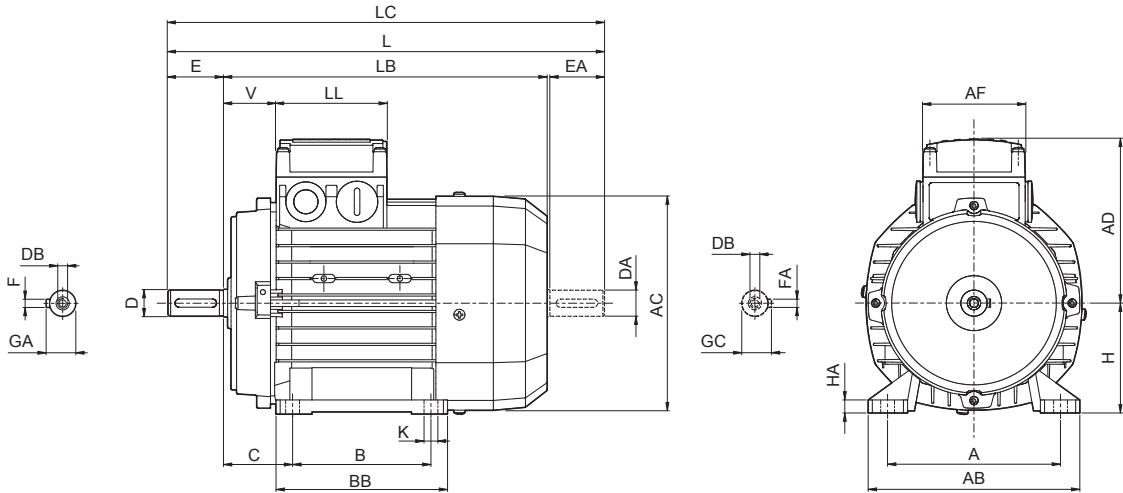

**BN**

	Shaft					Housing						Motor										
	D DA	E EA	DB	GA GC	F FA	B	A	HA	BB	AB	K	C	H	AC	L	LB	LC	AD	AF	LL	V	
<b>BN 63</b>	11	23	M4	12.5	4	80	100	8	96	120	7	40	63	121	207	184	232	95	74	80	30	
<b>BN 71</b>	14	30	M5	16	5	90	112	8	112	135		45	71	138	249	219	281	108				37
<b>BN 80</b>	19	40	M6	21.5	6	100	125	8	124	153		50	80	156	273	233	315	119				38
<b>BN 90 S</b>	24	50	M8	27	8	125	140	8	155	174	10	56	90	176	326	276	378	133	98	98	44	
<b>BN 90 L</b>							192					63										100
<b>BN 100</b>	28	60	M10	31	8	140	160	10	175	224		63	112	219	385	325	448	157				98
<b>BN 112</b>							190				70	112							219	385	325	
<b>BN 132 S</b>	38	80	M12	41	10	178	216	12	218	254	12	89	132	260	493	413	576	193	118	118	58	
<b>BN 132 M</b>							254					70										112
<b>BN 160 M</b>	42	110	M16	45	12	210	254	25	264	319		14.5	108	160	310	596	486	680				245
<b>BN 160 L</b>	38 (1)					M12 (1)			41 (1)		10 (1)					254			304	640	530	
<b>BN 180 L</b>	48	110	M16	51.5	14	279	279	26	329	359	14		121	180	348	708	598	823	261	187	187	52
<b>BN 200 L</b>	55											M20				59						
	42 (1)	M16 (1)	45 (1)	12 (1)	305	318	355	398	18	133		200	722	612	837	261	64					

NOTE:  
1) These values refer to the rear shaft end.

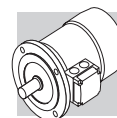

# BN - IM B5

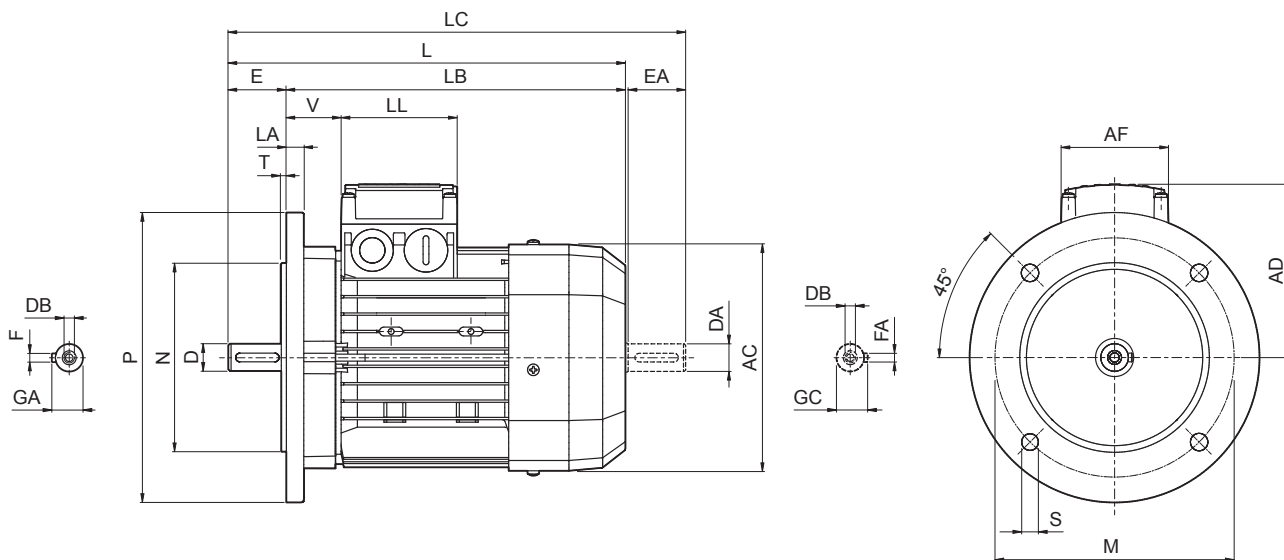

**BN**

	Shaft					Flange					Motor									
	D DA	E EA	DB	GA GC	F FA	M	N	P	S	T	LA	AC	L	LB	LC	AD	AF	LL	V	
<b>BN 56</b>	9	20	M3	10.2	3	100	80	120	7	3	8	110	185	165	207	91	74	80	34	
<b>BN 63</b>	11	23	M4	12.5	4	115	95	140	9.5		10	121	207	184	232				95	26
<b>BN 71</b>	14	30	M5	16	5	130	110	160			10	138	249	219	281				108	37
<b>BN 80</b>	19	40	M6	21.5	6	165	130	200	11.5	3.5	11.5	156	274	234	315	119	98	98	38	
<b>BN 90</b>	24	50	M8	27	8						176	326	276	378	133	44				
<b>BN 100</b>	28	60	M10	31	8	215	180	250	14	4	14	195	367	307	429	142	98	98	50	
<b>BN 112</b>											15	219	385	325	448	157			52	
<b>BN 132</b>	38	80	M12	41	10	265	230	300	18.5	5	20	258	493	413	576	193	118	118	58	
<b>BN 160 MR</b>	42 38 (1)	110 80 (1)	M16 M12 (1)	45 41 (1)	12 10 (1)	300	250	350			15		310	596	486				680	245
<b>BN 160 M</b>											15	310	596	486	680	245	51			
<b>BN 160 L</b>									15	310	596	486	680	245	51					
<b>BN 180 M</b>	48 38 (1)	110 110 (1)	M16 M12 (1)	51.5 41 (1)	14 10 (1)	350	300	400	18.5	5	18	348	310	640	530	724	187	187	52	
<b>BN 180 L</b>	48 42 (1)		M16 M16 (1)	51.5 45 (1)	14 12 (1)								18	348	708	598				823
<b>BN 200 L</b>	55 42 (1)		M20 M16 (1)	59 45 (1)	16 12 (1)						18	348	722	612	837	261	66			

NOTE:

1) These values refer to the rear shaft end.

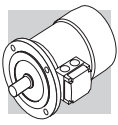

# BN - IM B14

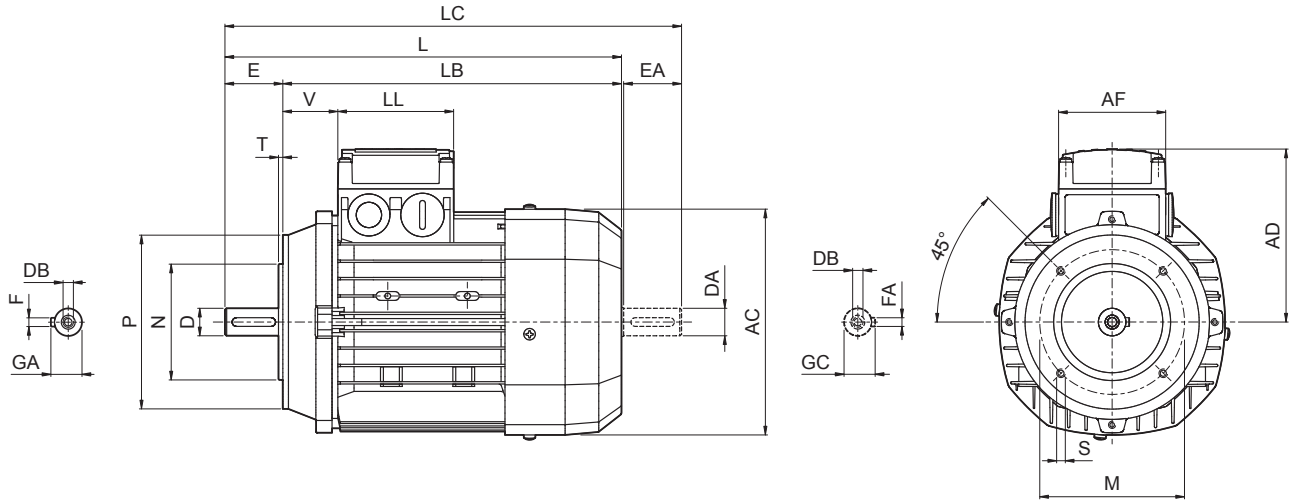

**BN**

	Shaft					Flange					Motor							
	D DA	E EA	DB	GA GC	F FA	M	N	P	S	T	AC	L	LB	LC	AD	AF	LL	V
<b>BN 56</b>	9	20	M3	10.2	3	65	50	80	M5	2.5	110	185	165	207	91	74	80	34
<b>BN 63</b>	11	23	M4	12.5	4	75	60	90			121	207	184	232	95			26
<b>BN 71</b>	14	30	M5	16	5	85	70	105	M6		138	249	219	281	108			37
<b>BN 80</b>	19	40	M6	21.5	6	100	80	120		3	156	274	234	315	119	38		
<b>BN 90</b>	24	50	M8	27	8	115	95	140	M8		3.5	176	326	276	378	133	98	98
<b>BN 100</b>	28	60	M10	31		130	110	160		195		367	307	429	142	50		
<b>BN 112</b>					219	385	325	448		157	52							
<b>BN 132</b>	38	80	M12	41	10	165	130	200	M10	4	258	493	413	576	193	118	118	58

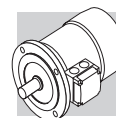

**BN\_FD ; IM B3**

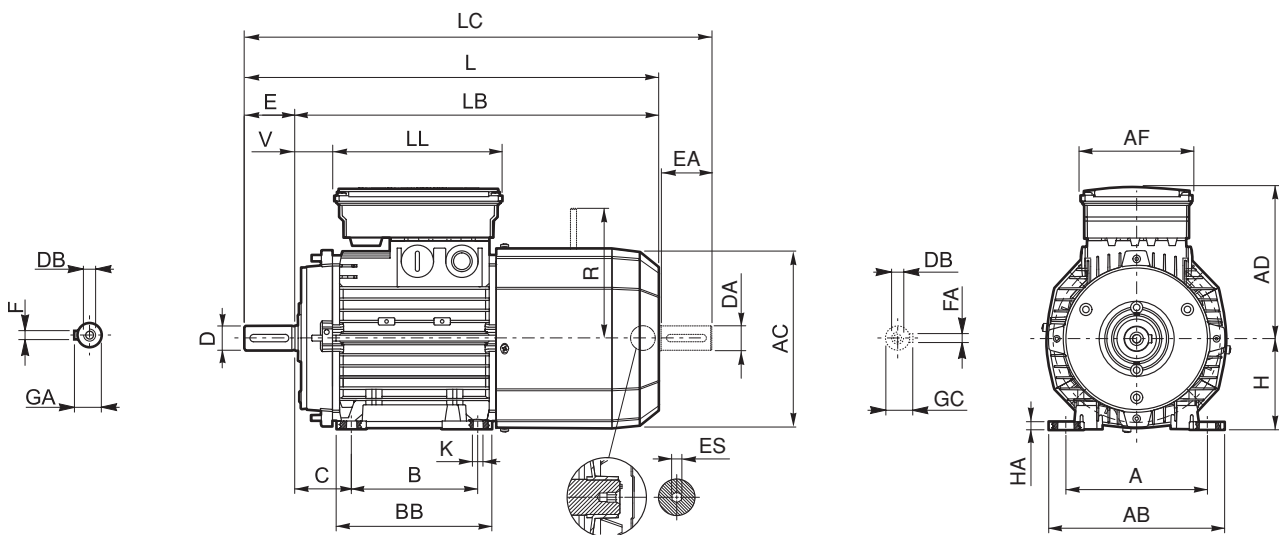

**BN**

	Shaft					Housing							Motor											
	D DA	E EA	DB	GA GC	F FA	B	A	HA	BB	AB	K	C	H	AC	L	LB	LC	AD	AF	LL	V	R	S	
<b>BN 63</b>	11	23	M4	12.5	4	80	100		96	120		40	63	121	272	249	297	122			14	96		
<b>BN 71</b>	14	30	M5	16	5	90	112		112	135	7	45	71	138	310	280	342	135	98	133	25	103	5	
<b>BN 80</b>	19	40	M6	21.5	6		125	8	124	153		50	80	156	346	306	388	146			41			
<b>BN 90 S</b>						100					10										15		129	
<b>BN 90 L</b>	24	50	M8	27			140		155	174		56	90	176	409	359	461	149			39			
<b>BN 100</b>					8		125												110	165	62		160	
<b>BN 112</b>	28	60	M10	31		140	190	10	175	224		70	112	219	484	424	547	173			73		199	
<b>BN 132 S</b>											12													
<b>BN 132 M</b>	38	80	M12	41	10	216	178	12	218	254		89	132	260	603	523	686	210	140	188	46		204 (2)	
<b>BN 160 M</b>	42	110	M16	45	12	210			264		14.5	108	160	310	736	626	820							
<b>BN 160 L</b>	38 (1)	80 (1)	M12 M16 (1)	41 (1)	10 (1)	254	254	25	319	304					780	670	864	245					51	266
<b>BN 180 L</b>	48	110	M16	51.5	14	279	279		329	359	14	121	180		866	756	981		187	187			52	
<b>BN 200 L</b>	55	110 (1)	M20	59	16	305	318	26	355	398	18	133	200	348	878	768	993	261					64	305
<b>BN 200 L</b>	42 (1)		M16	45 (1)	12 (1)																			

NOTE:  
1) These values refer to the rear shaft end.  
2) For FD07 brake value R=226.

ES hexagon is not supplied with PS option.

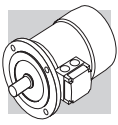

**BN\_FD ; IM B5**

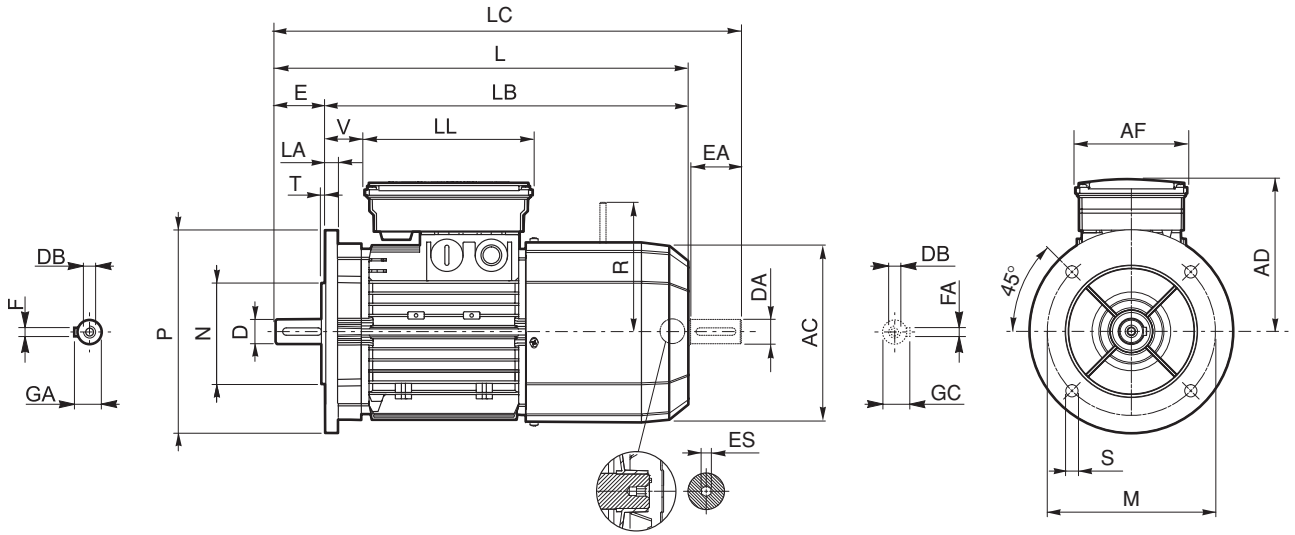

**BN**

	Shaft					Flange					Motor										
	D DA	E EA	DB	GA GC	F FA	M	N	P	S	T	LA	AC	L	LB	LC	AD	AF	LL	V	R	ES
<b>BN 63</b>	11	23	M4	12.5	4	115	95	140	9.5	3	10	121	272	249	297	122	98	133	14	96	5
<b>BN 71</b>	14	30	M5	16	5	130	110	160	9.5	3.5		138	310	280	342	135			110	165	
<b>BN 80</b>	19	40	M6	21.5	6	165	130	200	11.5		4	156	346	306	388	146	149	146			41
<b>BN 90 S</b>	24	50	M8	27	8					215		180	250	14	11.5	176			409	359	461
<b>BN 90 L</b>	28	60	M10	31		4	15	219	484		424				547	173	210	140	188	165	73
<b>BN 100</b>					38					80		M12	41	10							
<b>BN 132</b>	42	110	M16	45		12	300	250	350		18.5				5	310	736	626	820	245	187
<b>BN 160 MR</b>	38 (1)	80 (1)	M12 (1)	41 (1)	10 (1)	300				250		350	18.5	5							
<b>BN 160 M</b>	42	110	M16	45	12		300	250	350		18.5				5	310	780	670	864	245	187
<b>BN 160 L</b>	48	80 (1)	M12 (1)	51.5	14	300				250		350	18.5	5							
<b>BN 180 M</b>	38 (1)	80 (1)	M12 (1)	51.5	14		300	250	350		18.5				5	310	780	670	864	245	187
<b>BN 180 L</b>	48	110	M16	51.5	14	300				250		350	18.5	5							
<b>BN 200 L</b>	42 (1)	110	M16 (1)	45 (1)	12 (1)		300	250	350		18.5				5	310	780	670	864	245	187
<b>BN 180 L</b>	55	110 (1)	M20	59	16	350				300		400	18.5	5							
<b>BN 200 L</b>	42 (1)	110 (1)	M16 (1)	45 (1)	12 (1)		350	300	400		18.5				5	18	348	878	768	993	261
<b>BN 200 L</b>	42 (1)	110 (1)	M16 (1)	45 (1)	12 (1)	350				300		400	18.5	5							

NOTE:

1) These values refer to the rear shaft end.

2) For FD07 brake value R=226.

ES hexagon is not supplied with PS option.



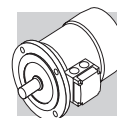

# BN\_FD ; IM B14

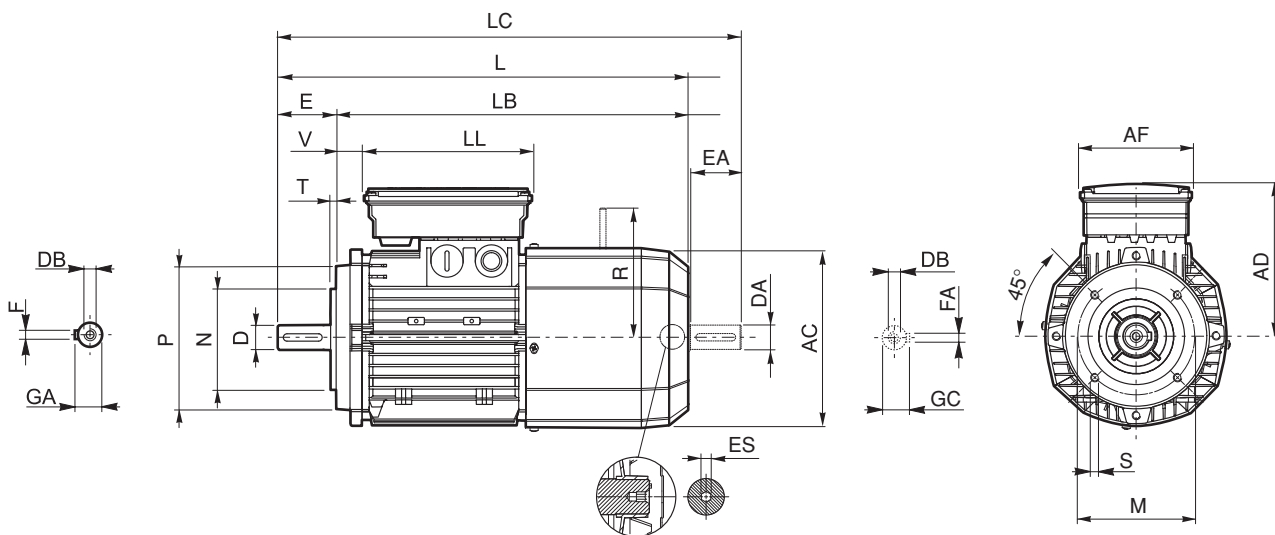

**BN**

	Shaft					Flange					Motor									
	D DA	E EA	DB	GA GC	F FA	M	N	P	S	T	AC	L	LB	LC	AD	AF	LL	V	R	ES
<b>BN 63</b>	11	23	M4	12.5	4	75	60	90	M5	2.5	121	272	249	297	122	98	133	14	96	5
<b>BN 71</b>	14	30	M5	16	5	85	70	105	M6		138	310	280	342	135			25	103	
<b>BN 80</b>	19	40	M6	21.5	6	100	80	120	M6		156	346	306	388	146			41	129	
<b>BN 90 S</b>	24	50	M8	27	8	115	95	140	M8	3	176	409	359	461	149	110	165	39	129	6
<b>BN 90 L</b>															146				160	
<b>BN 100</b>	28	60	M10	31	8	130	110	160	M8	3.5	195	458	398	521	158	110	165	62	160	6
<b>BN 112</b>															173				73	
<b>BN 132</b>	38	80	M12	41	10	165	130	200	M10	4	258	603	523	686	210	140	188	46	204 (1)	

NOTE:

1) For FD07 brake value R=226.

ES hexagon is not supplied with PS option.

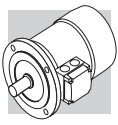

# BN\_FA - IM B3

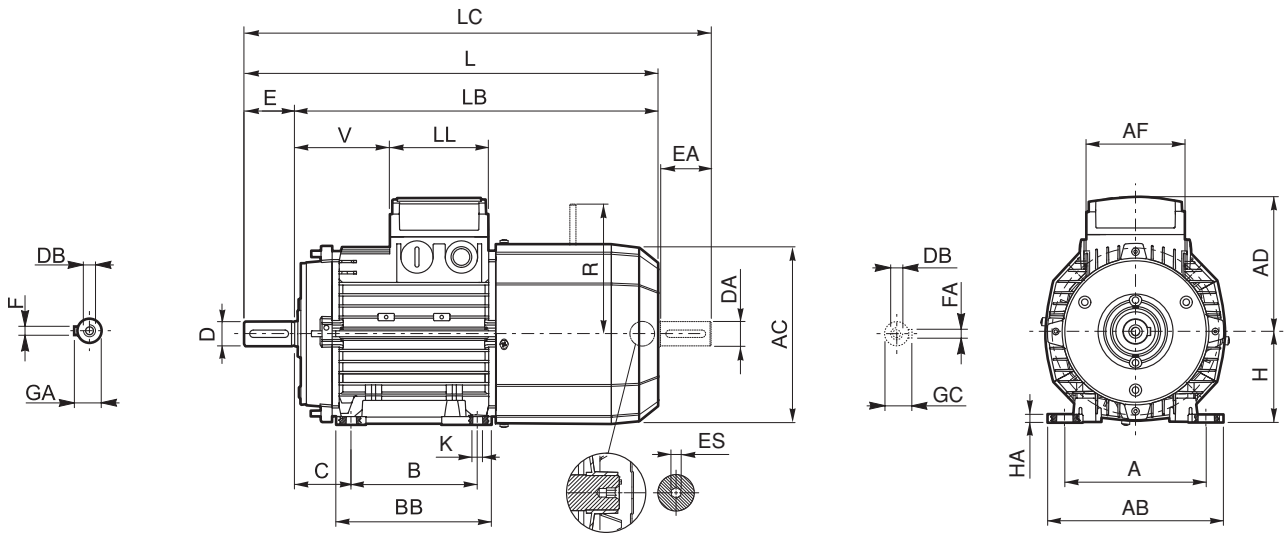

**BN**

	Shaft					Housing							Motor										
	D DA	E EA	DB	GA GC	F FA	B	A	HA	BB	AB	K	C	H	AC	L	LB	LC	AD	AF	LL	V	R	S
<b>BN 63</b>	11	23	M4	12.5	4	80	100	7	96	120	7	40	63	121	272	249	297	95	74	80	51	116	5
<b>BN 71</b>	14	30	M5	16	5	90	112		112	135		45	71	138	310	280	342	108			68	124	
<b>BN 80</b>	19	40	M6	21.5	6	100	125		8	124		153	50	80	156	346	306	388			119	83	
<b>BN 90 S</b>	24	50	M8	27	8	140	140	10	155	174	10	56	90	176	409	359	461	133	98	98	71	160	6
<b>BN 90 L</b>						125			192	70		112	219	484	424	547	157	128			198		
<b>BN 100</b>	28	60	M10	31	8	160	160	10	175	224	12	63	100	195	458	398	521	142	140	188	46	200 (2)	—
<b>BN 112</b>						140			190	89		132	260	603	523	686	210	187			187	51	
<b>BN 132 S</b>	38	80	M12	41	10	216	216	12	218	254	14.5	89	132	260	603	523	686	210	140	188	46	200 (2)	—
<b>BN 132 M</b>						178			304	108		160	310	736	626	820	245	187			187	51	
<b>BN 160 M</b>	42	110	M16	45	12	210	254	25	264	319	14.5	108	160	310	736	626	820	245	187	187	51	247	—
<b>BN 160 L</b>	38 (1)	80 (1)	M12 M12 (1)	41 (1)	10 (1)	254			304	780		670	864										

NOTE:

- 1) These values refer to the rear shaft end.
- 2) For FA07 brake value R=217.

Dimensions AD, AF, LL and V, relevant to terminal box of motors BN...FA featuring the separate brake supply (option SA), are coincident with corresponding dimensions of same-size BN...FD motors

ES hexagon is not supplied with PS option.

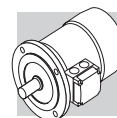

# BN\_FA - IM B5

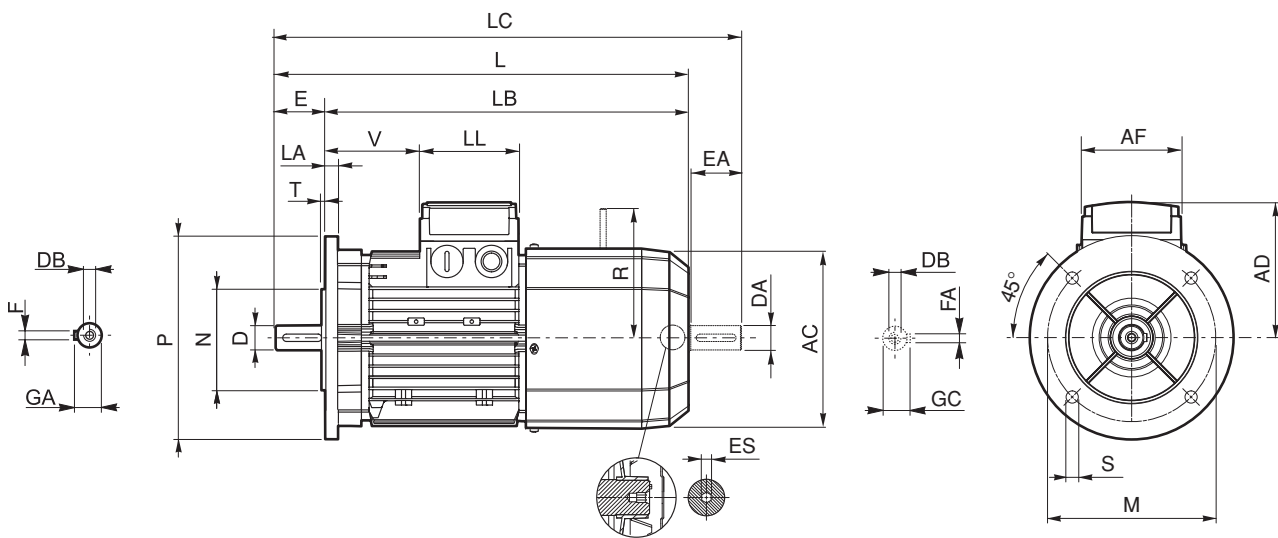

**BN**

	Shaft					Flange					Motor										
	D DA	E EA	DB	GA GC	F FA	M	N	P	S	T	LA	AC	L	LB	LC	AD	AF	LL	V	R	ES
<b>BN 63</b>	11	23	M4	12.5	4	115	95	140	9.5	3	10	121	272	249	297	95	74	80	26	116	5
<b>BN 71</b>	14	30	M5	16	5	130	110	160				138	310	280	342	108			68	124	
<b>BN 80</b>	19	40	M6	21.5	6	165	130	200	11.5	3.5	11.5	156	346	306	388	119			83	134	
<b>BN 90</b>	24	50	M8	27	8	215	180	250	14	4	14	176	409	359	461	133	98	98	95	160	6
<b>BN 100</b>	28	60	M10	31								195	458	398	521	142			128	198	
<b>BN 112</b>	38	80	M12	41	10	265	230	300	18.5	5	15	219	484	424	547	157	245	187	187	51	247
<b>BN 132</b>	42	110	M16	45	12	300	250	350				258	603	523	686	210					
<b>BN 160 MR</b>	38 (1)	80 (1)	M12 (1)	41 (1)	10 (1)	300	250	350	18.5	5	15	258	672	562	755	193	118	118	218	217	
<b>BN 160 M</b>												310	736	626	820	245	187	187	51	247	
<b>BN 160 L</b>												310	736	626	820	245	187	187	51	247	
<b>BN 180 M</b>												310	780	670	864	245	187	187	51	247	

NOTE:

- 1) These values refer to the rear shaft end.
- 2) For FA07 brake value R=217.

Dimensions AD, AF, LL and V, relevant to terminal box of motors BN...FA featuring the separate brake supply (option SA), are coincident with corresponding dimensions of same-size BN...FD motors

ES hexagon is not supplied with PS option.

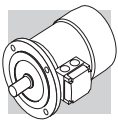

## BN\_FA - IM B14

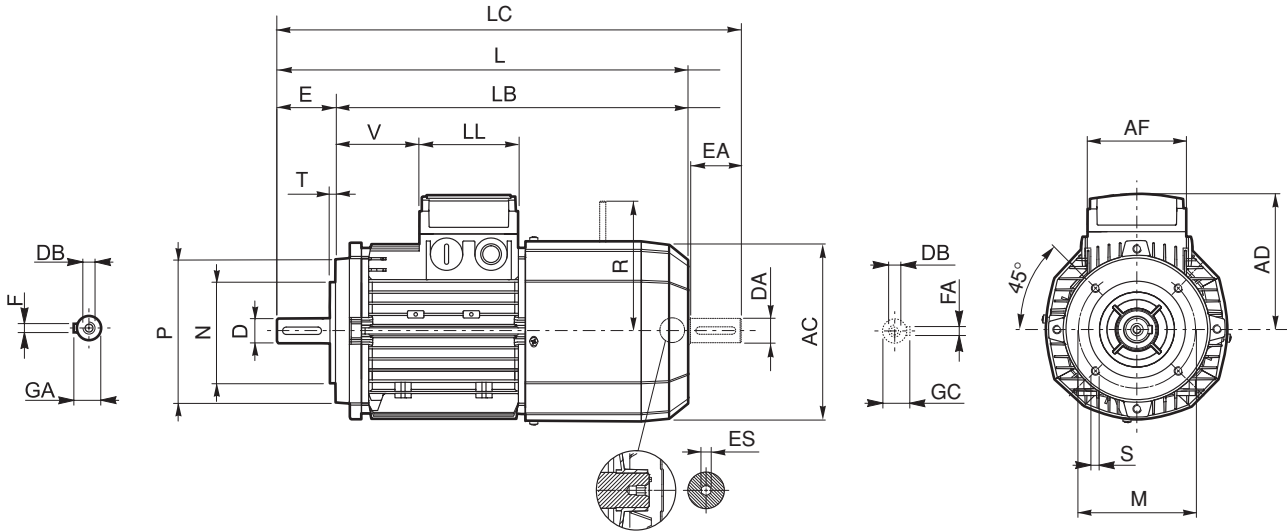

**BN**

	Shaft					Flange					Motor									
	D DA	E EA	DB	GA GC	F FA	M	N	P	S	T	AC	L	LB	LC	AD	AF	LL	V	R	ES
<b>BN 63</b>	11	23	M4	12.5	4	75	60	90	M5	2.5	121	272	249	119	95	74	80	26	116	5
<b>BN 71</b>	14	30	M5	16	5	85	70	105	M6		138	310	280	342	108			68	124	
<b>BN 80</b>	19	40	M6	21.5	6	100	80	120	M8	3	156	346	306	388	119	98	98	83	134	6
<b>BN 90</b>	24	50	M8	27	8	115	95	140		3	176	409	359	461	133			95	160	
<b>BN 100</b>	28	60	M10	31		130	110	160	M8	3.5	195	458	398	521	142	119	198			
<b>BN 112</b>					219						484	424	547	157	128	198				
<b>BN 132</b>	38	80	M12	41	10	165	130	200	M10	4	258	603	523	686	210	140	188	46	200 (1)	

NOTE:

1) For FA07 brake value R=217.

Dimensions AD, AF, LL and V, relevant to terminal box of motors BN...FA featuring the separate brake supply (option SA), are coincident with corresponding dimensions of same-size BN...FD motors

ES hexagon is not supplied with PS option.

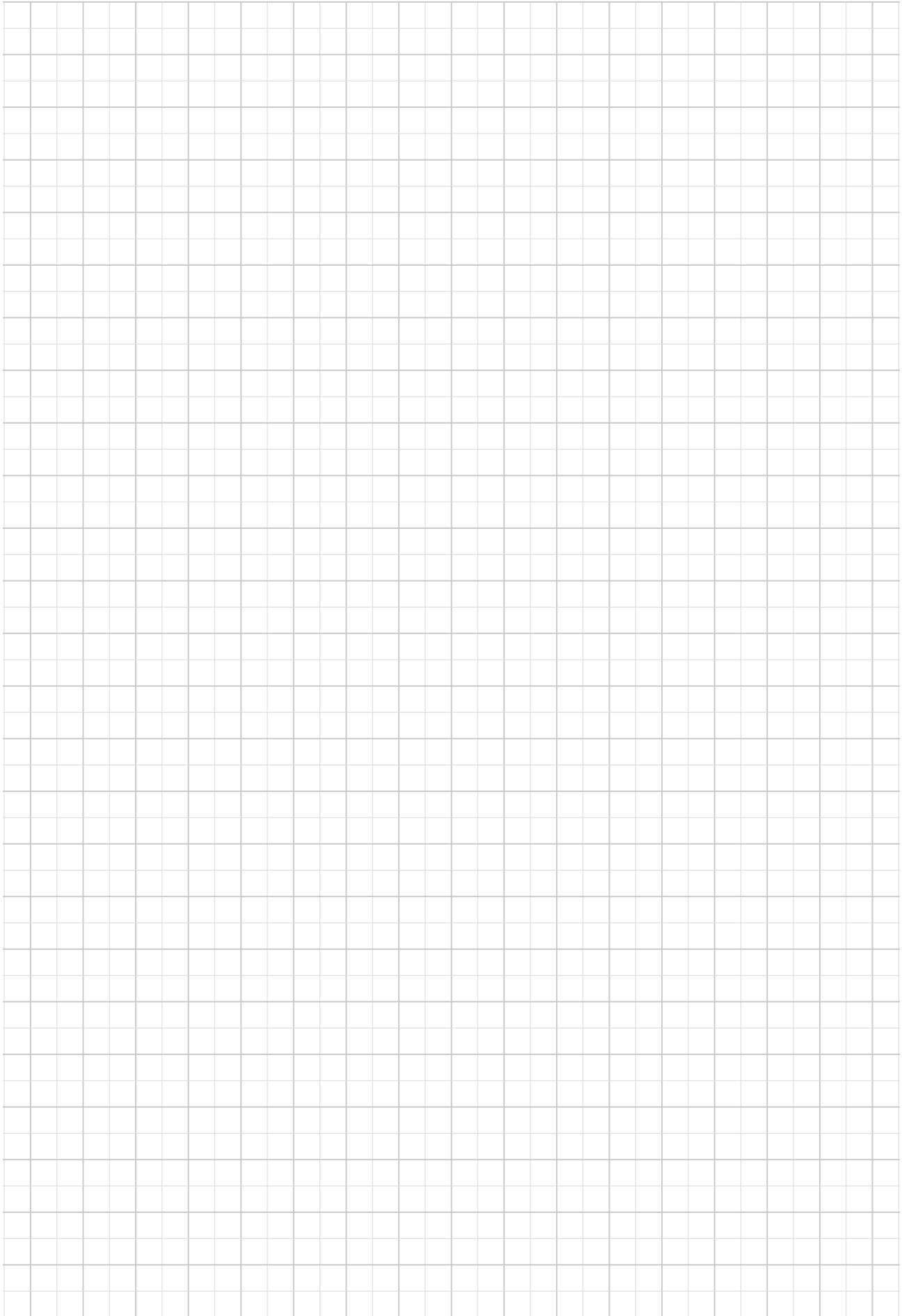
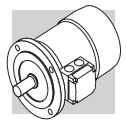

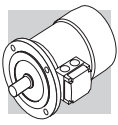

## INDEX OF REVISIONS

BR_CAT_BNEX_STD_ENG_R02_1	
	Description
28, 38	Amended tables for rectifier and specifications CON option

160930

This publication supersedes and replaces any previous edition and revision. We reserve the right to implement modifications without notice.

This catalogue cannot be reproduced, even partially, without prior consent.