

EPower™

MODEL

Ideal for

- Glass furnaces
- Melt heat treatment
- Food processing
- Multi-channel heaters
- High temperature furnaces
- Induction heating
- Vacuum furnace
- Large extruders

Features

- Fully software configurable
- Predictive Load Management
- Current 100A to 400A (nominal load 16A to 400A)
- Operation up to 50°C
- Voltage up to 690V ac
- All types of firing modes
- Better than 1% measurement accuracy
- Large, four row display
- Multi-channel unit
- Log file
- Optional I/O
- Modbus
- Profibus
- DeviceNet® communication
- Ethernet
- Voltage, current and power control
- Complete diagnostics



Advanced Power Controller Specification Sheet

EPower™ is the Eurotherm® series of advanced power control units. Combining the advantages of the latest technologies and innovations to produce a truly impressive performance for your process.

Ratings

The EPower current ratings cover the range from 100 amps up to 400 amps (nominal 16 Amps to 400 Amps). Ratings are designed at 40°C, but operation can be defined up to 50°C with associated deratings.

The voltage rating can go up to a maximum of 690 volts.

Predictive Load management (patent pending)

You can reduce your energy costs across your plant by utilising the Predictive Load Management functionality within EPower. This innovative feature provides a better distribution of energy across different loads in your installation by managing the priority and if necessary, load shedding.

Many more features are available (Log file management, advanced alarm strategy, optional I/O...) to provide you with the best of the technology for your process.

Multi channel unit

EPower includes seven different power configurations within one unit, depending on the number of power modules fitted. From single phase configuration to two times two phase control, the unit is perfectly modular and configurable to your process and requirements. Multiple zones can be controlled with one unit.

Display

The large 4 lines x 10 characters display provides a clear and unambiguous indication of the process values. The four-line message centre provides custom or standard views of information that is important to you.

Communication

Eurotherm has an approach to open communications, offering standard fieldbus networks such as Profibus DP and DeviceNet® communications. The use of Ethernet and (Modbus TCP) also make integration into PLCs and other supervisory systems easy to accomplish and for legacy applications Modbus RTU.

Configuration

“Quick Start” HMI menus provide an easy and friendly way to quickly configure the unit. With the more complex configurations using the iTools software package.



Invensys®
EUROTHERM®

SPECIFICATION

General Standards

The product is designed and produced to comply with BS EN60947-4-3 (Low voltage switch gear and control gear). Other applicable standards are cited where appropriate.

Installation Categories

General installation category details for the driver and power units are summarised in the table below.

	Installation Category	Rated impulse withstand voltage (Uimp)	Rated insulation voltage
	Communications II	0.5kV	50V
	Standard I/O II	0.5kV	50V
	Driver module power II	2.5kV	230V
	Relays III	4kV	230V
	Power Modules (up to 600V) III	6kV	600V
	Power Modules (690V) II	6kV	690V
	Auxiliary (fan) supply II	2.5kV	230V

Power (at 40°C)

Caution

Although the driver module supply voltage range is 85 to 265V ac, the fans (if any) fitted to the power (thyristor) modules are specified for use at one of 115V ac or 230V ac as specified at time of order. Before plugging the fan harness into the driver module, ensure that the utility supply voltage is suitable for the fan(s). Otherwise, fan life may be shortened or the cooling effect may not be sufficient, either case presenting a possible hazard to the equipment or to the operator.

Driver module

Voltage range: 85 to 265V ac
 Frequency range: 47 to 63Hz
 Power requirement: 60W + Power Module fans (15W each for 400A power modules; 10W each for 160A/250A modules)

Power module

Number of modules: Up to four identical units per driver unit
 Voltage range: 100 to 600V ac (+10% - 15%) or 100 to 690V ac (+10% - 15%) as specified at time of order
 Frequency range: 47 to 63Hz
 Nominal current: 16 to 400A depending on power module
 Power dissipation: 1.3W per Amp per phase

Cooling

Up to and including 100A: Natural convection
 Above 100A: Fan cooling. Fans are connected in parallel to driver module connector
 Fan supply voltage: 115 or 230V ac, as specified at time of order (see 'Caution' above)
 Fan power requirement: 10VA for 160A/250A modules; 15VA for 400A modules

Protection

Thyristor drive: RC circuits and high-speed fuses (Type 1)

Pollution degree:

Pollution degree 2 (EN60947-1)

Rated short circuit

conditional current: 92kA

Utilisation categories

AC51: non inductive of slightly inductive loads, resistance furnaces
 AC56a: switching of transformers

Duty cycle:

Uninterrupted duty/continuous operation

Form designation:

Form 4

Short circuit protection

co-ordination type: Type1

Load types:

Single or multiphase control of resistive loads (low/high temperature coefficient and non-aging/aging types) and transformer primaries. Load voltage/current feedback either internal (standard) or external (option for use with transformer secondaries for example)

Physical

Dimensions and fixing centres

See Fixing Details

Weight:

(including 2kg for driver module)

Current	1 phase	2 phases	3 phases	4 phases
100A	6.5kg	11.0kg	15.5kg	20.0kg
160A	6.9kg	11.8kg	16.7kg	21.6kg
250A	7.8kg	13.6kg	19.4kg	25.2kg
400A	11.8kg	21.6kg	31.4kg	41.2kg

Environment

Temperature limits

Operating: 0°C to 50°C

(derate above 40°C as per accompanying curves)

Storage: -25°C to 70°C

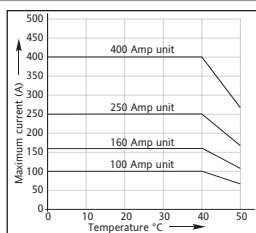

Atmosphere:

Non-explosive, non-corrosive and non-conductive

Humidity limits:

5% to 95% RH (non-condensing)

Altitude (maximum):

2000 metres

Protection:

IP10 (EN60529)

External wiring:

Must comply with IEC 364

Shock (EN60068-2-29):

10g Pk; 6mS duration; 10 bumps

Vibration (EN60068-2-6):

67-150Hz at 1g

EMC

Standard:

EN60947-4-3 Emissions class A

This product has been designed for environment A (Industrial). Use of this product in environment B (domestic, commercial and light industrial) may cause unwanted electromagnetic disturbances in which cases the user may be required to take adequate mitigation measures.

Immunity criteria:

Immunity criterion 1 (criterion 3 for voltage dips and short-time interruptions)

Operator Interface

Display:

4 lines of up to 10 characters each. Display pages can be used to view process variable values and to view and edit the configuration of the unit. (Editing of the configuration is better carried out using configuration software (iTools). In addition to the standard displays, up to four 'custom' pages can be defined which allow bargraph displays, text entry etc.

Character format:

7 high x 5 wide yellow-green LCD dot matrix array

Push buttons:

4 push buttons provide page and item entry and scroll facilities

LED indicators (beacons):

3 indicators (PWR LOC and ALM) are supplied to indicate that power is applied, that Local Control is selected and that there is one or more active alarm respectively

Standard Inputs/Outputs (SK1)

All figures are with respect to driver module 0V, unless otherwise stated.

Number of inputs/outputs

No of analogue inputs: 2

No of analogue outputs: 1

No of digital inputs/outputs: 2 (each configurable as an input or an output)

10V (Potentiometer) supply: 1

Update rate:

Twice the mains frequency applied to power module 1. Defaults to 41.6Hz (24mS) if no power applied to power module1 or if the frequency lies outside the range 47 to 63Hz)

Termination:

Removable 10-way connector. (5.08 mm. pitch)

ANALOGUE INPUTS

Performance: See Tables 1 and 2

Input types: Each input is configurable as one of: 0 to 10V, 1 to 5V, 2 to 10V, 0 to 5V, 0 to 20mA, 4 to 20 mA

Absolute maxima

+ terminal: ±16V or ±40mA

- terminal: ±1.5V or ±300mA

Analogue input: Voltage input performance

Parameter	Typical	Max/Min
Total voltage working input span (note 1)		-0.25V to +12.5V
Resolution (noise free) (note 2)	13 bits	
Calibration error (notes 3, 4)	<0.25%	<0.5%
Linearity error (note 3)		±0.1%
Ambient temperature error (note 3)		<0.01%/°C
Input resistance (+ve terminal)		>140kΩ
Input resistance (-ve terminal)	150Ω	
Allowable voltage (-ve terminal to 0V)		±1V
Series mode rejection of mains interference	46dB	>30dB
Common mode dc rejection	46dB	>40dB
Hardware response time	5ms	

Note 1: w.r.t. to the relevant -ve input

Note 2: w.r.t. total working span

Note 3: % of effective range (0 to 5V, 0 to 10V)

Note 4: After warm up. Ambient = 25°C

Table 1 Analogue input specification table (voltage inputs)

Analogue input: Current input performance

Parameter	Typical	Max/Min
Total current working input span		-1mA to +25mA
Resolution (noise free) (note 1)	12 bits	
Calibration error (notes 2, 3)	<0.25%	<0.5%
Linearity error (note 2)		±0.1%
Ambient temperature error (note 2)		<0.01%/°C
Input resistance (+ve to -ve terminal)	235Ω	
Input resistance (-ve terminal)	150Ω	
Allowable voltage (-ve terminal to 0V)		<±1V
Series mode rejection of mains interference	46dB	>30dB
Common mode dc rejection	46dB	>40dB
Hardware response time	5ms	

Note 1: w.r.t. total working span

Note 2: % of effective range (0 to 20mA)

Note 3: After warm up. Ambient =25°C

Table 2 Analogue input specification table (current inputs)

ANALOGUE OUTPUTS

Performance: See Tables 3 and 4
 Output types: Each output is configurable as one of 0 to 10V, 1 to 5V, 2 to 10V, 0 to 5V, 0 to 20mA, 4 to 20 mA
 Absolute maxima + terminal: (-0.7V or -300mA) or (+16V or +40mA)
 0V terminal: ±2A

Analogue output: Voltage output performance		
Parameter	Typical	Max/Min
Total voltage working span (within ±20mA (typ.) current span)		-0.5V to +12.5V
Short circuit current		<24mA
Resolution (noise free) (note 1)	12.5 bits	
Calibration error (note 2, note 3)	<0.25%	<0.5%
Linearity error (note 2)		<±0.1%/°C
Ambient temperature error (note 2)		<±0.01%/°C
Minimum load resistance		>800Ω
DC output impedance		<2Ω
Hardware response time (10% to 90%)	20ms	<25ms
Note 1: w.r.t. total working span		
Note 2: % of effective range (0 to 5V, 0 to 10V)		
Note 3: After warm up. Ambient = 25°C		

Table 3 Analogue output specification table (voltage outputs)

Analogue output: Current output performance		
Parameter	Typical	Max/Min
Total current working span (within -0.3V to +12.5V voltage span)		-24mA to +24mA
Open circuit voltage		<16V
Resolution (noise free) (note 1)	12.5 bits	
Calibration error (note 2, note 3)	<0.25%	<0.5%
Linearity error (note 2)		<±0.1%/°C
Ambient temperature error (note 2)		<±0.01%/°C
Maximum load resistance		<550Ω
DC Output conductance		<1µA/V
Hardware response time (10% to 90%)	20ms	<25ms
Note 1: w.r.t. total working span		
Note 2: % of effective range (0 to 20mA)		
Note 3: After warm up. Ambient = 25°C		

Table 4 Analogue output specification table (current outputs)

10V SUPPLY (POTENTIOMETER SUPPLY)

Output voltage: 10.3V ± 0.3V @ 5.5mA
 Short circuit o/p current: 15mA max.
 Ambient temperature drift: ± 0.012%/°C (typ); ±0.04%/°C (max.)
 Absolute maxima Pin 1: (-0.7V or -300mA) or (+16V or +40mA)

DIGITAL I/O

Hardware response time: 100µs
Voltage inputs
 Active level (high): 4.4V < Vin < 30V
 Non-active level (low): -30V < Vin < +2.3V
 Input impedance: 10kΩ
Contact closure input
 Source current: 10mA min; 15mA max
 Open contact (non active) resistance: >500Ω
 Closed contact (active) resistance: <150Ω
Current source output
 Source current: 9mA < I_{source} < 14mA @ 14V
 10mA < I_{source} < 15mA @ 0V
 9mA < I_{source} < 14mA @ -15V
 Open circuit voltage: <14V
 Internal pull-down resistance: 10kΩ (to 0V)
 Absolute maxima + terminal: ±30V or ±25mA
 - terminal: ±2A

Notes:

1. Absolute maximum ratings refer to externally applied signals
2. The 10V potentiometer supply is designed to supply two 5kΩ potentiometers connected in parallel with one another.
3. The maximum current for any 0V terminal is ±2A.

Relay Specification

The relays associated with this product have gold plated contacts applicable to 'dry circuit' (low current) use.

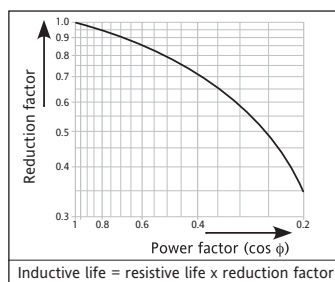

Contact life Resistive loads: 100,000 operations (de-rate with inductive loads as per figure)
 High power use Current: <2A (resistive loads)
 Voltage: <264V RMS
 Low power use Current: >1mA
 Voltage: >1V
 Contact configuration: Single pole change-over (One set of Common, Normally Open and Normally Closed contacts)
 Termination Relay 1 (standard): 3-way connector on underside of driver unit
 Watchdog relay (standard): 3-way connector on underside of driver unit
 Relays two to four (option): 12-way option module connector
 Absolute max switching capability: <2A at 240V RMS (resistive loads)

Note: Normally closed and normally open refer to the relay when the coil is not energised.

Optional Input/Output Modules (SK3, SK4, SK5)

Up to three input/output modules can be fitted, each containing the inputs and outputs detailed below. Unless otherwise stated below, the specification for the optional I/O (including relays) is as given above for the standard I/O.

Termination: Removable 12-way (5.08mm pitch) connector per module
 Number of modules: Up to 3
 Number of inputs: 1 analogue input and 2 digital inputs per module
 Number of outputs: 1 analogue output per module
 Number of relays: 1 set of common, normally open and normally closed contacts per module
 10V potentiometer supply output voltage: 10.0V ±0.3V at 5.5mA

Mains Network Measurements

All network measurements are calculated over a full mains cycle, but internally updated every half-cycle. For this reason, power control, current limits and alarms all run at the mains half-cycle rate. The calculations are based on network waveform samples, taken at a rate of 20kHz. Measurements on each network phase are synchronised to its own phase and if the line voltage cannot be detected, the measurements will stop for that phase. It should be noted that, depending on the network configuration, the phase voltage referred to is one of:

- a. the line voltage referenced to neutral in four star,
- b. the line voltage referenced to neutral or another phase for single phase networks or
- c. the line voltage referenced to the phase applied to the next adjacent power module for three phase star or delta networks.

The parameters below are directly derived from measurements for each phase.

Accuracy (20 to 25°C)
 Line frequency (F): ±0.02Hz
 Line RMS voltage (Vline): ±0.5% of Nominal Vline
 Load RMS voltage (V): ±0.5% of Nominal V
 Thyristor RMS current (I): ±0.5% of Nominal I
 Load RMS voltage squared (Vs_q): ±1% of (Nominal V)²
 Thyristor RMS current squared (Is_q): ±1% of (Nominal I)²
 True load power (P): ±1% of (Nominal V) x (Nominal I)
 Frequency resolution: 0.01Hz
 Measurement resolution: 11 bits of Nominal value (noise free)
 Meas. drift with ambient temp: <0.02% of reading /°C

Further parameters (S, PF, Q, Z, Iavg, IsqBurst, IsqMax, Vavg, Vs_q Burst, Vs_qMax and PBurst) are derived from the above, for each network (if relevant). See EPower User Guide Section 6.19.1 (Meas submenu) for further details.

Communications

Ethernet
 Type: 10baseT (IEEE801)
 Protocol: Modbus TCP
 Connector: RJ45 with indicators (Green = Tx activity; Yellow = Network activity)
Modbus RTU
 Protocol: Modbus RTU slave
 Transmission standard: 3-wire EIA485
 Connector: Twin, parallel-wired RJ45, with indicators (Green = Tx activity; Yellow = Rx activity)
 Isolation (EN60947-4-3): Installation category II, Pollution degree 2
 Terminals to ground: 50V RMS or dc to ground (double isolation)

ELECTRICAL INSTALLATION

Drive Unit Connectors

Configuration Port (EIA232)

Beacons Power Local Alarm

Pushbuttons Return Scroll down Scroll up Enter

SK1 Standard I/O

1	+10 Volts out
2	Analogue i/p 1+
3	Analogue i/p 1-
4	Analogue i/p 2+
5	Analogue i/p 2-
6	Analogue o/p 1
7	Analogue o/p 1 0V
8	Digital i/o 1+
9	Digital i/o 2+
10	Digital i/o 0V

SK2 Predictive Load Management Option

1	Terminator A
2	Low
3	Shield
4	High
5	Terminator B

SK3 Optional I/O 1

1	+10 Volts out
2	Analogue i/p 3+
3	Analogue i/p 3-
4	Analogue o/p 2+
5	Analogue o/p 2 0V
6	Digital i/p 3-
7	Digital i/p 4+
8	Digital 0V
9	Not used
10	Relay 2 NO (24)
11	Relay 2 Com (21)
12	Relay 2 NC (22)

SK4 Optional I/O 2

1	+10 Volts out
2	Analogue i/p 4+
3	Analogue i/p 4-
4	Analogue o/p 3+
5	Analogue o/p 3 0V
6	Digital i/p 5+
7	Digital i/p 6+
8	Digital 0V
9	Not used
10	Relay 3 NO (34)
11	Relay 3 Com (31)
12	Relay 3 NC (32)

SK5 Optional I/O 3

1	+10 Volts out
2	Analogue i/p 5+
3	Analogue i/p 5-
4	Analogue o/p 4+
5	Analogue o/p 4 0V
6	Digital i/p 7+
7	Digital i/p 8+
8	Digital 0V
9	Not used
10	Relay 4 NO (44)
11	Relay 4 Com (41)
12	Relay 4 NC (42)

Relay 1 (De-energised)

Watchdog Relay (De-energised)

NO = Normally open
NC = Normally closed
Com = Common

Remote display (isolated EIA485)

Supply in N L

Supply output for power module fan(s) N L E

Power Unit Connectors

External feedback connections (optional)

Load current I1 I2

Load Voltage V1 V2

Neutral/phase reference (either pin)

Load cable exit

View on underside of Drive unit

View on underside of Power unit

FIXING DETAILS

100Amps

Front view

Recommended fixing bolt size = M6 Cable entry 21.5mm

61.4mm 107.5mm 85.0mm 85.0mm 85.0mm 42.0mm

6.5mm 330mm 317mm

Safety earth (M6)

Door (Open)

Insert 5mm screwdriver here, and pull down to release door

Communications

E F G H

View on underside

252.2mm Cable exit/entry 194.4mm

Note: Units are shown with individual mounting brackets. Multi-phase units come supplied with 2, 3 or 4 phase brackets as appropriate. See table below for details.

No of phases	Overall Widths				Bracket	Upper	Lower
	1	2	3	4			
Door closed	149.5	234.5	319.5	404.5	2-phase	Use A & B	Use E & F
Door open	211.0	296.0	381.0	466.0	3-phase	Use A, B & C	Use E, F & G
					4-phase	Use A, B, C & D	Use E, F, G & H

160Amps

Front view

Recommended fixing bolt size = M6 Cable entry 21.5mm

61.4mm 107.5mm 85.0mm 85.0mm 85.0mm 42.0mm

6.5mm 361mm 348mm

Safety earth (M6)

Door (Open)

Insert 5mm screwdriver here, and pull down to release door

Communications

E F G H

View on underside

252.2mm Cable exit/entry 194.4mm

Note: Units are shown with individual mounting brackets. Multi-phase units come supplied with 2, 3 or 4 phase brackets as appropriate. See table below for details.

No of phases	Overall Widths				Bracket	Upper	Lower
	1	2	3	4			
Door closed	149.5	234.5	319.5	404.5	2-phase	Use A & B	Use E & F
Door open	211.0	296.0	381.0	466.0	3-phase	Use A, B & C	Use E, F & G
					4-phase	Use A, B, C & D	Use E, F, G & H

Communications

Modbus RTU pinout

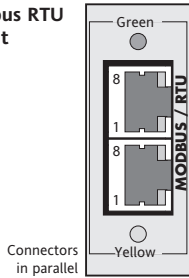

Pin	3-wire
8	Reserved
7	Reserved
6	N/C
5	N/C
4	N/C
3	Isolated 0V
2	A
1	B

Internal connections :
Pin 1 to 5V via 100kΩ
Pin 2 to 0V via 100kΩ

LEDs:
Green = Tx activity
Yellow = Rx activity

Network Status LED Indication	
LED state	Interpretation
Off	Off-line or no power
Steady green	On-line to one or more units
Flashing green	On-line - no connections
Steady red	Critical link failure
Flashing red	1 or more connections timed out

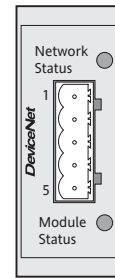

DeviceNet connector pinout

Pin	Function
1	V- (negative bus supply voltage)
2	CAN_L
3	Cable shield
4	CAN_H
5	V+ (positive bus supply voltage)

- Notes:**
- See DeviceNet specification for power supply specification
 - During startup, an LED test is performed, satisfying the DeviceNet standard.

Modbus TCP (Ethernet 10baseT) pinout

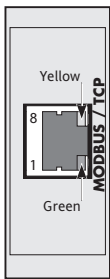

Pin	Function
8	N/C
7	N/C
6	Rx-
5	N/C
4	N/C
3	Rx+
2	Tx-
1	Tx

LEDs:
Green = Tx activity
Yellow = Network activity

Operation Mode LED Indication	
LED state	Interpretation
Off	Off-line or no power
Steady green	On-line, data exchange
Flashing green	On-line, clear
Red single flash	Parametrisation error
Red double flash	Profibus configuration error

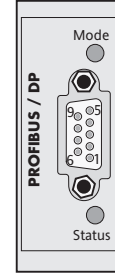

Profibus connector pinout

Pin	Function	Pin	Function
9	N/C	5	Isolated ground
8	A (RxD -/TxD -)	4	RTS
7	N/C	3	B (RxD+ / TxD+)
6	+5 V (See note 1)	2	N/C
		1	N/C

- Notes:**
- Isolated 5 Volts for termination purposes. Any current drawn from this terminal affects the total power consumption.
 - The cable screen should be terminated to the connector housing.

250Amps

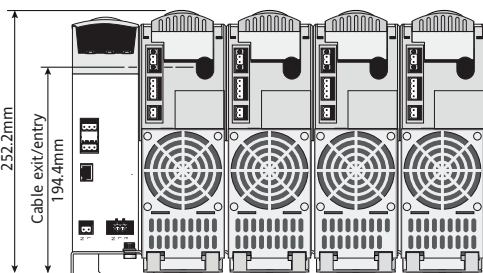
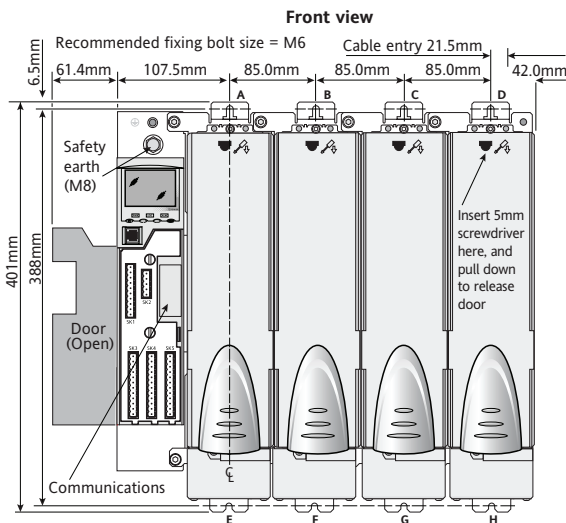

Note: Units are shown with individual mounting brackets. Multi-phase units come supplied with 2, 3 or 4 phase brackets as appropriate. See table below for details.

No of phases	Overall Widths				Bracket	Upper	Lower
	1	2	3	4			
Door closed	149.5	234.5	319.5	404.5	2-phase	Use A & B	Use E & F
Door open	211.0	296.0	381.0	466.0	3-phase	Use A, B & C	Use E, F & G
					4-phase	Use A, B, C & D	Use E, F, G & H

400Amps

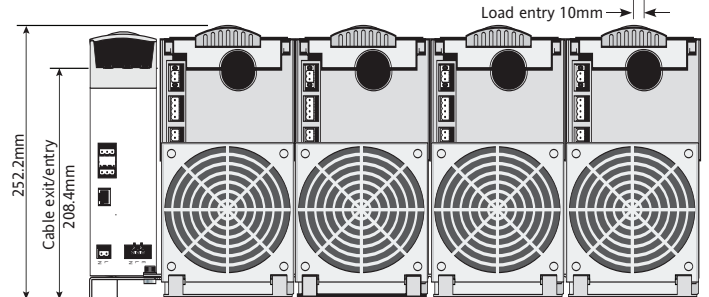
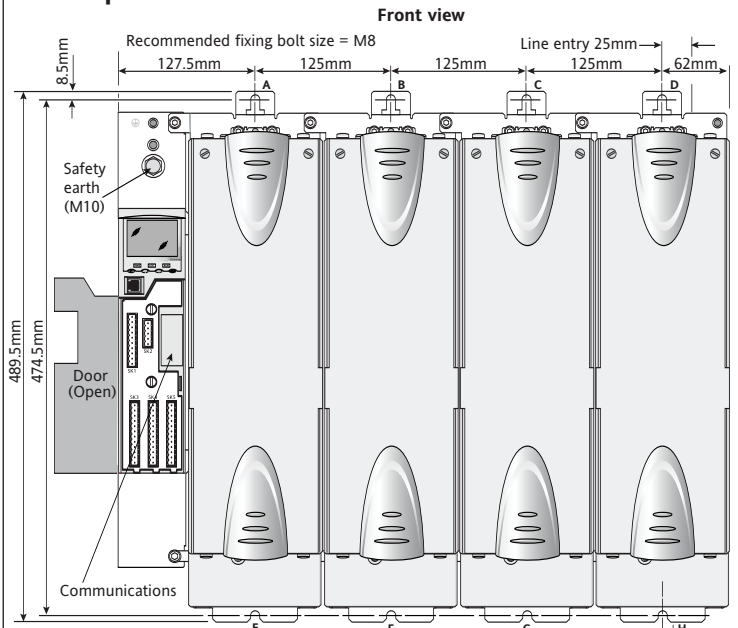

Note: Units are shown with individual mounting brackets. Multi-phase units come supplied with 2, 3 or 4 phase brackets as appropriate. See table below for details.

No of phases	Overall Widths				Bracket	Upper	Lower
	1	2	3	4			
Door closed	189.5	314.5	439.5	564.5	2-phase	Use A & B	Use E & F
Door open	251.0	376.0	501.0	626.0	3-phase	Use A, B & C	Use E, F & G
					4-phase	Use A, B, C & D	Use E, F, G & H

ORDER CODES

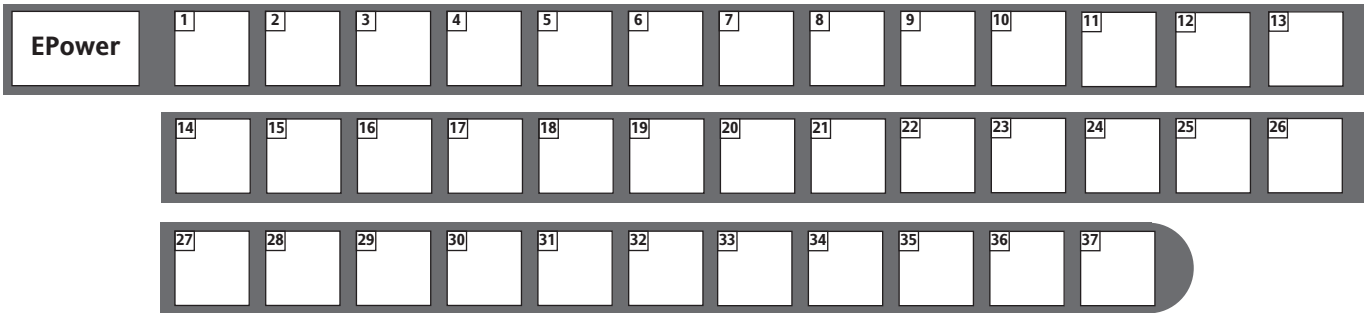

The code is divided in three sections:

- 1 Hardware, which defines the type, number and size of the unit and/or the modules.
- 2 Optional hardware and software functions.
- 3 QuickStart which is intend to configure the unit for maximum 60 to 80% of the application (single unit in 1, 2 or 3 legs configuration)

The code can then be either “Short” and include only the main hardware fields or “medium” and combine the hardware + the optional fields, or finally “Long” with the additional quick start code at the end.

Product		8 Communication Protocol		19 Language	
EPower	Power Controller	XX	No optional fieldbus communication	ENG	English
		Y2	2-wire 485 Modbus (RJ45 connector)	FRA	French
		PB	Profibus-DPV1 (with D type connector)	GER	German
		ET	Modbus-TCP	ITA	Italian
		DN	DeviceNet	SPA	Spanish
1 Phase / Amps		9 Module 1		20 Load Current (nominal)	
1PH-100A	1 Phase unit 100 amps	XX	None	16A	16 Amps
1PH-160A	1 Phase unit 160 amps	IO	IO optional board	25A	25 Amps
1PH-250A	1 Phase unit 250 amps			40A	40 Amps
1PH-400A	1 Phase unit 400 amps			50A	50 Amps
2PH-100A	2 Phase unit 100 amps	10 Module 2		63A	63 Amps
2PH-160A	2 Phase unit 160 amps	XX	None	80A	80 Amps
2PH-250A	2 Phase unit 250 amps	IO	IO optional board	100A	100 Amps
2PH-400A	2 Phase unit 400 amps			125A	125 Amps (1)
3PH-100A	3 Phase unit 100 amps	11 Module 3		160A	160 Amps (1)
3PH-160A	3 Phase unit 160 amps	XX	None	200A	200 Amps (1)
3PH-250A	3 Phase unit 250 amps	IO	IO optional board	250A	250 Amps (1)
3PH-400A	3 Phase unit 400 amps			315A	315 Amps (1)
4PH-100A	4 Phase unit 100 amps	12 Predictive Load Management		400A	400 Amps (1)
4PH-160A	4 Phase unit 160 amps	XXX	None		
4PH-250A	4 Phase unit 250 amps	ELM	Predictive Load Management	21 Load Voltage (nominal)	
4PH-400A	4 Phase unit 400 amps			100V	100 Volts
PWR-100A	100A Power module	13 Not Used		110V	110 Volts
PWR-160A	160A Power module	XX	None - Standard unit	115V	115 Volts
PWR-250A	250A Power module	14 Not Used		120V	120 Volts
PWR-400A	400A Power module	XX	None	127V	127 Volts
DRV-XXX	Driver module only	15 Software Option 1		200V	200 Volts
		XXX	None	208V	208 Volts
		16 Software Option 2		220V	220 Volts
		XXX	None	230V	230 Volts
		17 Not Used		240V	240 Volts
		XX	Default	277V	277 Volts
		18 QuickStart		380V	380 Volts
		XX	None - End of code	400V	400 Volts
		QS	QuickStart config	415V	415 Volts
				440V	440 Volts
				460V	460 Volts
				480V	480 Volts
				500V	500 Volts
				575V	575 Volts
				600V	600 Volts
				660V	660 Volts (2)
				690V	690 Volts (2)
		22 Control Type (3)			
		1P	Single phase		
		2P	Two phase control		
		3P	Three phase control		
		23 Load Configuration (4)			
		1P	Single phase		
		3S	Star		
		3D	Delta		
		4S	Star with neutral		
		6D	Open delta		



24 Load Type

XX	Resistive
TR	Transformer primary

25 Firing Mode

PA	Phase angle (5)
HC	Half cycle
BF	Burst firing (default 16 cycles)
FX	Fix modulation period (default 2 seconds)
LG	Logic mode

26 Feedback

V2	RMS load voltage squared
I2	RMS load current squared
TP	True power
VR	RMS load voltage
IR	RMS load current
OL	Open loop

27 Current Transfer Mode (Linear Current Limit)

XXX	Off
I2	RMS load current squared transfer
IR	RMS load current transfer

28 Analog Input 1 Function

XX	None
SP	Setpoint
HR	Setpoint limit
IL	Current limit
VL	Voltage limit
PL	Power limit
TS	Current transfer span

29 Analog Input 1 Type

0V	0-10 Volt
1V	1-5 Volt
2V	2-10 Volt
5V	0-5 Volt
0A	0-20 mA
4A	4-20 mA

30 Analog Input 2 Function

XX	None
SP	Setpoint
HR	Setpoint limit
IL	Current limit
VL	Voltage limit
PL	Power limit
TS	Current transfer span

31 Analog Input 2 Type

0V	0-10 Volt
1V	1-5 Volt
2V	2-10 Volt
5V	0-5 Volt
0A	0-20 mA
4A	4-20 mA

32 Analog Output Function

X	None
V	Voltage
I	Current
P	Power
R	Impedance

33 Analog Output Type

0V	0-10 Volt
1V	1-5 Volt
2V	2-10 Volt
5V	0-5 Volt
0A	0-20 mA
4A	4-20 mA

34 Digital Input 2 Function

XX	None
AK	Alarm acknowledgement
RS	Remote setpoint selection

35 Alarm Relay Configuration

XX	None
AA	Any alarm
PA	Process alarms
FB	Fuse blown

36 Load Management Configuration

XX	None -- Load Management disabled
SH	Sharing
I1	Incremental Type 1
I2	Incremental Type 2
RI	Rotating Incremental
DC	Distributed Control
DI	Distributed Control and Incremental Control
RD	Rotating Distributed Control and Incremental Control

37 Predictive Load Management Address

XX	Predictive Load Management address (00 to 63) Default address 00
----	--

Notes

- (1) The maximum nominal current selectable is \leq the current rating selected in Field 1.
- (2) Only available if 690V selected in Field 2.
- (3) Selection dependent on number of Phases selected in Field 1
 1PH = IP only
 2PH = IP or 2P only
 3PH = IP or 3P only
 4PH = IP or 2P only
- (4) Selection dependent on number of Phases selected in Field 1
 1PH = 1P only
 2PH = 1P, 3S or 3D only
 3PH = Any
 4PH = 1P, 3S or 3D only
 If IP selected in Field 22 only option is IP
- (5) PA not selectable if 2P selected in Field 22

Spare fuses for power modules

Current rating	Fuse reference
100 Amp	CS179139U315
160 Amp	CS179139U315
250 Amp	CS179139U315
400 Amp	CS179439U550

GENERAL DIAGRAMS

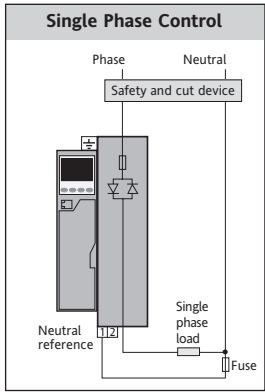

Single Phase Control up to
Four Single Phase Control

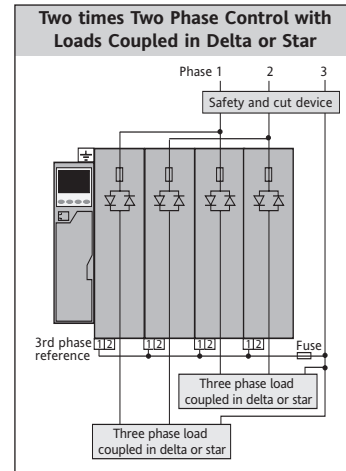
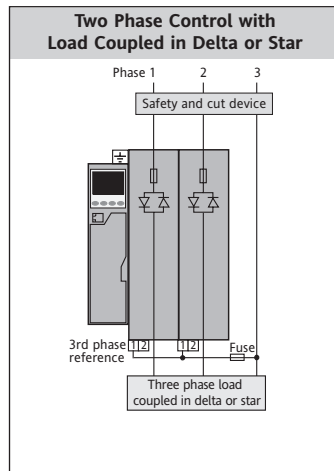
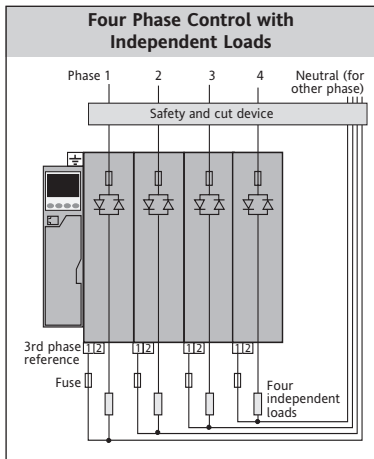
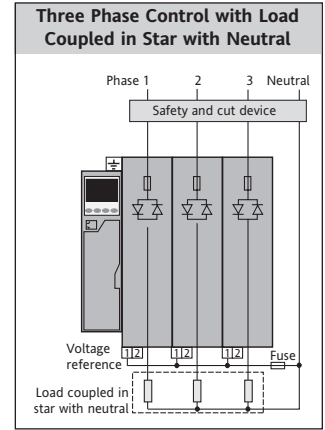
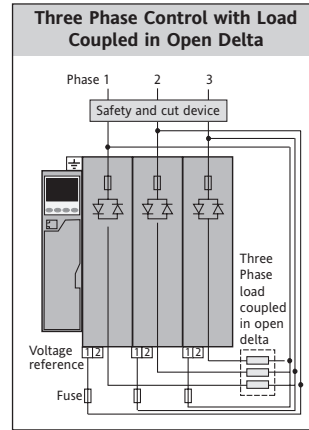
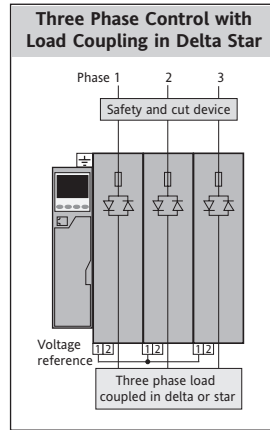

© Copyright Eurotherm Limited 2007

Invensys, Eurotherm, the Eurotherm logo, Chessell, EurothermSuite, Mini8, Eycon, Eyris, EPower and Wonderware are trademarks of Invensys plc, its subsidiaries and affiliates. All other brands may be trademarks of their respective owners.

All rights are strictly reserved. No part of this document may be reproduced, modified, or transmitted in any form by any means, nor may it be stored in a retrieval system other than for the purpose to act as an aid in operating the equipment to which the document relates, without the prior written permission of Eurotherm limited.

Eurotherm Limited pursues a policy of continuous development and product improvement. The specifications in this document may therefore be changed without notice. The information in this document is given in good faith, but is intended for guidance only.

Eurotherm Limited will accept no responsibility for any losses arising from errors in this document.